

EEM

*Enginemen's
Operating
Manual*

MODEL F7



ELECTRO-MOTIVE DIVISION
GENERAL MOTORS CORPORATION • LA GRANGE, ILLINOIS, U. S. A.

DIESEL LOCOMOTIVE OPERATING MANUAL

NO. 2310

FOR

MODEL F7

**With Vapor Car Steam Generator
and Elesco Steam Generator**

4th Edition

March, 1950

This manual has been written to specifically cover operation of the F7 locomotive. However, it may be used for the operation of other freight type General Motors locomotives.

Coverage of the Dynamic Brake is included. The manual is written to be complete with or without this coverage so that on locomotives not equipped with Dynamic Brake reference to this subject may be eliminated without detracting from coverage of the locomotive.

Price \$2.50

ELECTRO-MOTIVE DIVISION

General Motors Corporation
LA GRANGE, ILLINOIS, U. S. A.

TABLE OF CONTENTS

	Page
SECTION 1 - GENERAL DESCRIPTION	100
Engineman's Controls	102
Engineman's Instrument Panel	106
Switches	108
Air Brake Equipment	109
Miscellaneous Equipment	110
Engine Room	115
SECTION 2 - NORMAL OPERATION	200
Preliminary	200
Handling a Train	205
Braking	209
Miscellaneous Operating Instructions	211
SECTION 3 - SPECIAL CONDITIONS AND PROBLEMS DURING OPERATION	300
Problems During Operation	309
Specific Difficulties	313
SECTION 4 - COOLING, LUBRICATING OIL AND FUEL OIL SYSTEMS	400
Cooling System	400
Lubricating Oil System	401
Fuel Oil System	402
SECTION 5 - ON-THE-ROAD TROUBLE- SHOOTING	500
SECTION 6 - STEAM GENERATOR	600

SECTION I

GENERAL DESCRIPTION

A description and general location of equipment on the basic F7 locomotive is given in this section.

A locomotive consists of one or more units rated at 1500 horsepower each. The units which are equipped with an operating cab are designated "A" units, those without cabs as "B" or Booster units. Different combinations of units are used, depending on the horsepower and operating requirements.

100 Diesel Engines Each unit has a 16-cylinder 2-cycle Model 567B Diesel engine which drives the main generator and auxiliaries described later.

101 Main Generator and Alternator The main generator and alternator assembly are directly connected to the Diesel engine crankshaft through a flexible coupling. Two electrically separate sections are mounted on the same shaft and designated as Model D12-D14. The D12 portion produces direct current at a nominal voltage of 600 volts for operation of the traction motors. The D14 section, built into the engine end of the main generator frame is a three phase, 80 KW alternating current generator which furnishes power to drive the engine water cooling fans and the traction motor blowers.

102 Traction Motors Four traction motors are used in each unit, mounted one on each axle. Each motor is geared to the axle which it drives by a motor pinion gear meshing with an axle gear. The gear ratio between the two gears is expressed as a double number such as 62/15. In this case, the axle gear has 62 teeth while the pinion has 15 teeth.

During acceleration four steps of traction motor electrical connections (called transition) are used:

- | | |
|--------------------------|-------------------|
| 1. Series-Parallel | 3. Parallel |
| 2. Series-Parallel-Shunt | 4. Parallel-Shunt |

This transition compares roughly to "hooking up" a steam locomotive making it possible to utilize the full horsepower output of the engines and takes place automatically while operating locomotives in automatic transition position. When operating in manual transition position, the engineman must move the transition lever to the proper position when the transition indicator reaches a shifting point. During deceleration the steps take place in reverse order.

103 Reversing Locomotive Reversing the locomotive is accomplished by moving the reverse lever in the control stand to the desired direction. The reverse lever must be moved only when the locomotive is standing still.

104 Auxiliary Equipment Auxiliary equipment in the F7 locomotive is driven entirely by direct drive from the Diesel engine or by separate electric motors. No belts are used in the locomotive.

The 10 KW auxiliary generator is directly driven from the Diesel engine. It produces direct current at approximately 74 volts to charge the storage batteries and supply the low voltage circuits for lighting, control, generator field excitation, fuel pump operation, etc. The air compressor is driven through a flexible coupling from the armature shaft of the main generator. It is a three cylinder, two stage compressor.

An electric driven blower is provided for each traction motor. These blowers supply the cooling air for the traction motors. Electric driven cooling fans supply the air for the engine cooling water radiators.

ENGINEMAN'S CONTROLS

Three levers and the two brake valve handles control the entire operation of the locomotive. These are the throttle, reverse and transition levers which are mounted in the control stand and the independent and automatic brake valve handles.

105 Throttle Lever This lever controls the speed of the engines and the train speed in normal operation. The position of the throttle is shown in the illuminated indicator above the lever. The throttle has ten positions, stop, idle and running speeds 1 to 8. Stop can be obtained by depressing the emergency stop button on the end of the throttle lever and pushing the throttle lever 1 step beyond the idle position. This stops all engines. Idle position is as far forward as the throttle lever can be moved without depressing the emergency stop button. Each running notch on the throttle increases the engine speed 75 RPM from 275 RPM at idle to 800 RPM at full throttle. Mechanical interlocks prevent the throttle from being opened more than one notch at a time to prevent rough train handling. The throttle may be closed completely with one motion in an emergency, but should be closed only one notch at a time in normal operation.

106 Reverse Lever The reverse lever can be removed from the control stand in neutral position only. This locks the operating controls in the control stand. With the reverse lever in neutral position, the power circuits will not close.

107 Transition Lever This lever is on the left side of the control stand. Its position is shown in an illuminated indicator in the control stand. The locomotive is started with the transition lever in the No. 1 position and is advanced as the speed increases

LEGEND OF ENGINEMAN'S CONTROLS

1. Automatic Brake Valve
2. Full Release Selector Cock
3. First Service Position Cock
4. Instrument Panel Light Switch
5. Safety Control Cock
6. Brake Valve Cutout Cock
7. Safety Control Foot Pedal
8. Rotair Valve
9. Cab Heater Steam Valve
10. Reverse Lever
11. Transition Lever
12. Speed Recorder
13. Horn Cords
14. Load and Transition Indicating Meter
15. Throttle Lever
16. Heater Switch
17. Windshield Wiper Valve
18. Equalizing Reservoir and Main Reservoir Air Gauge
19. Independent Brake Valve
20. Brake Pipe and Brake Cylinder Air Gauge
21. Bell Valve
22. Application Pipe and Suppression Pipe Air Gauge
(If Used)
23. Engineman's Watch Receptacle (If Used)
24. Wheel Slip Indicator Light
25. Dynamic Brake Warning Light
26. PCS Open Light

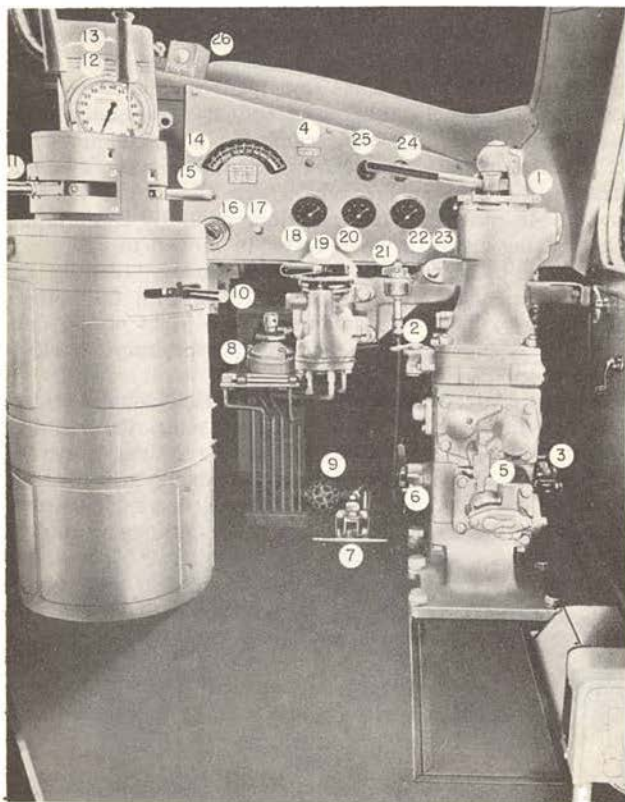

Engineman's Controls

Fig. 1-1

The dial of the meter is graduated into amperes starting at 0 at the left and going to 1000 amperes at extreme right of the scale. There are four transition zones (safe operating zones) colored green, and an overload zone colored yellow.

A red diamond and a black line at 825 amperes show the maximum continuous current rating. A red triangle at 600 amperes shows the maximum permissible current when using dynamic brakes. A white pointer moves across the dial to indicate the amount of traction motor amperes.

A blank space exists between the transition areas. When shifting manually from one area to a higher area, wait until the pointer has reached the edge of the higher area and shift promptly. When shifting to a lower area, wait until the pointer has reached the edge of the lower area and shift promptly.

A plate is mounted below the meter dial showing the time it is permissible to operate at different stages of overload. These "short time overload" ratings are accumulative.

112 Wheel Slip Light This light indicates that the locomotive wheels are slipping, and the throttle should be reduced one or more notches to stop the slipping. The wheel slip light does not flash when transition is made from series-parallel to parallel and back to series-parallel as it did with older locomotives. If the light should flash, consistently, during transition, this condition should be reported.

113 Dynamic Brake Warning Light (If Used)

If the dynamic brake in any of the units is overloaded this light will indicate that the brake should be reduced.

SWITCHES

The engineman's control push-button switch box is located above the side window at the engineman's station. It contains switches for control, light and accessory circuits. The switches are clearly labeled for their respective uses, Fig. 1-3. The distribution panel located on the right side of the electrical control cabinet in the engine room has a number of main switches all of which are to be closed during normal operation. Fig. 5-3.

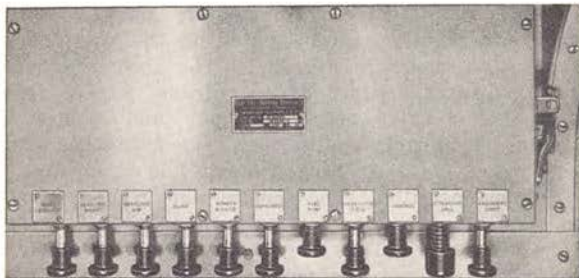

Engineman's Control Push-Button Switch Box
Fig. 1-3

114 PC Switch The pneumatic control switch (PC) is an air operated electric switch. This switch is tripped by any "penalty" application of the air brakes. On most locomotives an emergency application of the brake will also trip the "PC" switch. When this switch is tripped, it automatically reduces the speed of the engines to idle and shuts off all fuel pumps. If the throttle is in the 5th or 6th notch when the PC switch is tripped, the engines will stop. Some locomotives are equipped with an indicating light which will show when the switch is tripped. To reset the switch the throttle must be returned to idle and the

brake "recovered." When this has been accomplished the "PC" switch will reset itself and the indicating light will go out.

AIR BRAKE EQUIPMENT

The 24 RL brake equipment is normally used on the F7 locomotives. The air brake gauges are located on the instrument panel in front of the engineman. In general, the cab air brake equipment consists of the automatic brake valve, the independent brake valve and the K-2-A Rotair valve, a manually operated valve having four positions and located to the right of the controller as shown in Fig. 1-1. The automatic brake valve handle has 6 positions — release, running, first service, lap, service and emergency; and may be of the rigid or hinged handle type. The automatic brake valve handle (rigid or hinged handle) is removable in the running position. The handle should be removed when a double cab locomotive is being operated from the opposite end. The hinged handle, if required by the railroad, is used to suppress a safety control from the foot pedal by depressing the handle to a horizontal position. On some railroads a sanding bail provides sanding by further depressing the handle.

The brake valve, Fig. 1-4, also contains:

1. Brake valve cutout cock, located on the filling piece portion.
2. Safety control cutout cock, located on the service application portion.
3. First service position cock.
4. Full release selector cock.

116 Independent Brake Valve The S-40-F independent brake valve handle has two positions, release and full application, with the application zone between the two positions. The brake valve is of the

self-lapping type which automatically laps off the flow of air and maintains brake cylinder pressure, when the application pressure reaches the value corresponding to the position of the brake valve handle in the application zone. Release of locomotive brakes after automatic application is obtained by depressing the independent brake valve handle in release position.

117 K-2-A Rotair Valve The four positions of the K-2-A Rotair valve are "FRGHT," "FRGHT LAP" "PASS LAP" and "PASS." See "Operation" for handling of this valve.

118 Safety Control Foot Pedal The safety control foot pedal is located in front of the engineman's seat. On locomotives equipped with the DS-24-H brake valve, having the hinged automatic brake valve handle, the handle provides an alternate control when it is depressed sufficiently to just contact the sanding bail. Either the pedal or the automatic brake valve handle must be kept depressed at all times except when the locomotive is stopped and the locomotive brakes are applied (30 pounds or more brake cylinder pressure). If both the foot pedal and the automatic brake valve are released at the same time, a penalty application of the brakes will result.

MISCELLANEOUS EQUIPMENT

119 Sanding Valve When the locomotive is equipped with the hinged automatic brake valve handle, sanding is accomplished by depressing the lever beyond the safety control position previously described. This movement operates the sanding bail which opens a port to supply air to the sanding equipment. On locomotives having a rigid handle on the automatic brake valve, an independent sanding valve is installed. This lever is operated by pushing the lever forward until it latches.

DESCRIPTION**F7-1-249**

Fig. 1-4

K-2-A ROTAIR
VALVE

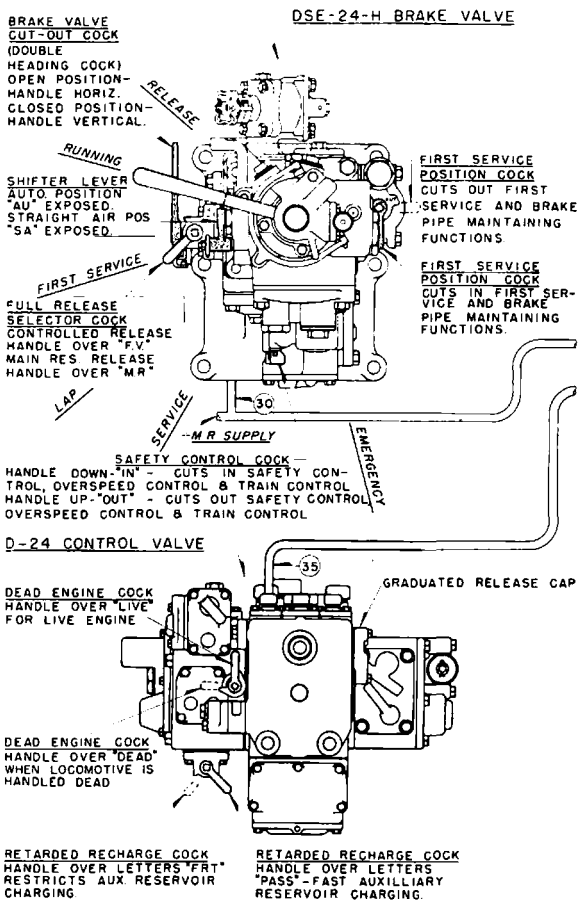
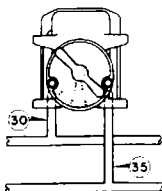

HANDLE OVER LETTERS "FRGT"

CUTS IN CONTROLLED EMERGENCY FEATURE, SPLIT SERVICE REDUCTION, & INDEPENDENT BRAKE VALVE

HANDLE OVER LETTERS "FRGT LAP" *

CUTS OUT INDEPENDENT BRAKE VALVE. CONTROLLED EMERGENCY STILL IN EFFECT

HANDLE OVER LETTERS "PASS LAP" *

CUTS OUT CONTROLLED EMERGENCY & THE INDEPENDENT BRAKE VALVE.

HANDLE OVER LETTERS "PASS"

ALL FEATURES REMAIN CUTOFF AS IN "PASS LAP", EXCEPT INDEPENDENT BRAKE VALVE IS CUT IN

* POSITION USED FOR TRAILING "A" UNITS.

TO INDEPENDENT BRAKE VALVE

"B" UNIT CONTROL VALVE SECTION

NOTE WHEN DOUBLE HEADING, THE ROTAIR VALVE ON THE SECOND OPERATING UNIT SHOULD BE LEFT IN A LIVE POSITION, "FRGT" OR "PASS", TO RETAIN USE OF INDEPENDENT BRAKE VALVE

WHEN OPERATING A "B" UNIT ALONE WITH THE HOSTLER'S CONTROL, THE CONTROLLED EMERGENCY SELECTOR COCK MUST BE PLACED IN "PASS" POSITION TO EFFECT QUICK ACTING EMERGENCY IF NEEDED

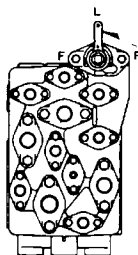

HANDLE OVER "F"

CUTS IN CONTROLLED-EMERGENCY BRAKE CYLINDER PRESSURE DEVELOPMENT FEATURE.

HANDLE OVER "L"

POSITION NOT USED WITH OUR EQUIPMENT HANDLE MUST BE IN PASSENGER OR FREIGHT POSITION

HANDLE OVER "P"

CUTS OUT CONTROLLED-EMERGENCY BRAKE CYLINDER PRESSURE DEVELOPMENT FEATURE

VIEW OF PIPE BRACKET FOR CONTROL VALVES
SHOWING CONTROLLED-EMERGENCY CUT-OUT COCK IN "B" UNITS

**Cock Handle Positions
24 RL Brake
All Types Of Service
Fig. 1-4**

119 Speed Recorder-Locomotive Overspeed Control

The speed recorder, located in front of the control stand, is a hydraulically operated speed indicator with a speed recording tape and an odometer. It is driven from the number 1 axle of the "A" unit, through a flexible cable. It contains a maximum speed device which will initiate a full service application of the brakes and trip the PC switch when the maximum speed setting is exceeded. On some railroads, instead of a full service application of the brakes, the brakes go into emergency.

120 Unit Selector Switch (Dynamic Brake)

The unit selector switch located next to the engineer's instrument panel has four positions and should be set corresponding to the number of units making up the locomotive. The unit selector switch should be set before leaving the maintenance point. If one or more engines should be isolated en route this switch must not be changed. The only time this switch is changed is if the locomotive consist is changed.

121 Windshield Wipers

The windshield wipers are controlled by valves, one of which is located on the engineer's instrument panel, and one on the panel on the fireman's side of the cab. These wipers operate independently of each other. The wipers should not be run on a dry window as dirt on the glass or blade will scratch the glass.

122 Horn Valves

The horns are operated by air valves which are controlled by pull-cords, above the control stand. The horn shut-off valve is located in front of the No. 2 main reservoir.

123 Locomotive Bell

The locomotive signal bell is under the locomotive floor behind the pilot on the left side. It is operated by an air valve located

at the engineman's station. The bell shut-off valve is located to the left side of the front end of No. 2 main reservoir.

124 Cab Heaters A cab heater is located on each side of the cab. Hot water from the engine cooling water system passes through the heaters and motor driven fans provide air circulation. The flow of water to both heaters is controlled by a valve in the supply line, located over the left hand engine room steps. This valve must be kept wide open at all times in freezing weather. The output of each heater can be varied by use of the cab heater switches. The switches have four positions "OFF" 1, 2, 3, which provide three different motor speeds. If engine in the lead unit is shut down in freezing weather, steam may be admitted to the cab heaters.

125 Defrosters Each side of the cab is equipped with a defroster motor and fan which blows heated air on the inside of the front cab windows. Both motors are turned on and off by the one defroster switch in the control push-button switch box.

126 Classification Lights A permanently fixed, clear bull's-eye is provided on each side of the nose. Inside the nose and behind each bull's-eye, a small compartment contains the classification light bulb and colored lenses. Red and green lenses are provided in each compartment which can be moved into a position between the bulb and the bull's-eye. To accomplish this, a locking pin is removed, the desired lens swung into place and the locking pin replaced. The lenses are accessible from the inside of the nose section through hinged doors in the compartments. When both red and green lenses are out of position the permanent bull's-eye lens will show a white light, thus making three colors available.

ENGINE ROOM

The two ends of the engine are designated "FRONT" and "REAR" as shown in Fig. 1-5, which will serve to identify the cylinder locations, ends and sides of the engine, as they are referred to in this manual. The governor, water pumps, and lubricating oil pumps are on the "FRONT END." The blowers, oil separator and generator are mounted on the "REAR END."

The engine is placed so that its rear end is toward the front end of the unit when the unit is operating in its normally forward direction.

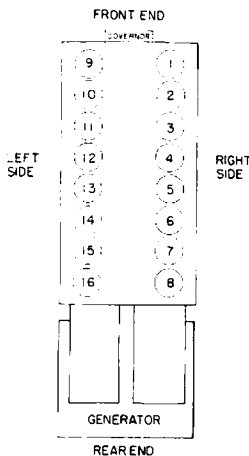

Fig. 1-5

127 Engine Control and Instrument Panel This panel is mounted on a frame which supports the engine cooling water tank near the governor end of the engine. Each power plant has its own engine control and instrument panel on which are mounted the lube oil pressure and suction gauges, fuel tank gauge, along with the start, stop, fuel pump and isolation switches.

128 Isolation Switch This switch has two positions "START" (handle horizontal) and "RUN" (handle pointing down vertically). In "START" position, the power plant is disconnected from the control circuit, and engine is reduced to idle speed. The engine will remain at idle speed and will not respond to throttle control. The power contactors in the electrical control

cabinet will not operate when the transition lever is moved. In dynamic braking, the unit will exert no retarding effect. The "Alternator Failure" alarm is inoperative. The "START" and "STOP" buttons are effective only when the isolation switch is in "START" position.

129 **Governor, Governor Speed and Safety Control**

The engine is equipped with a Woodward Governor which includes an electro-hydraulic governor speed control, and an unloader used during transition. In case of low oil pressure or high vacuum on the suction side of the lube oil pump, the engine governor will stop the engine. The alarm bells will sound in all units of the locomotive. The yellow "Low Oil" and the blue "Alternator Failure" signal light will show in the unit affected. When the governor safety control stops the engine, the push button on the front of the governor housing moves out approximately 3/8" exposing a red band around the shaft of the button. The governor reset push button must be pressed in to extinguish the "Low Oil" alarm lights and the isolation switch moved to "START" position to extinguish the "Alternator Failure" alarm lights. Both actions are necessary to stop alarm bells. The push button will not trip if the engine stops due to placing of throttle in emergency stop position, operation of manual layshaft control lever, tripping of ground protective relay when throttle is in run 5 or run 6, or use of the "STOP" button for normal shutdown. In these instances, the "LOW OIL" alarm lights will not light but the "Alternator Failure" alarm will function (except when the "STOP" button is used) to serve as a warning that an engine is stopped. When the engine is stopped by governor control action, the push button must be reset before the engine can be started. When the engine is started and run at idling speed, the governor will stop the engine again after approximately forty seconds, if the condition still exists which caused the original shutdown. This time delay is provided to allow

a check to determine the cause of the shutdown. However, if an attempt is made to run the engine above idling speed during the delay period, the governor will stop the engine at once should the oil pressure be low or the oil pump suction be high.

130 Electrical Control Cabinet The electrical control cabinet contains the various contactors, relays, and other equipment necessary for the electrical and electro-pneumatic control of the unit.

131 Control Air Pressure Regulator The "control air," for operating power contactors, reverser and cam switch is supplied from the main reservoir and reduced to 80 ± 3 pounds by the control air pressure regulator. The pressure regulator is located behind the steps leading into the operating cab on the right (engineman's) side of locomotive. The pressure is indicated on a gauge in the distribution panel just below main battery switch.

132 Load Regulator The load regulator is located diagonally below the engine control panel, its movement is controlled by a pilot valve and a dump valve in the engine governor. The load regulator controls the loading of the main generator, and automatically maintains a constant horsepower output, corresponding to each throttle position throughout the entire range of engine speed.

133 Layshaft Manual Control Lever The layshaft manual control lever is attached to the end of the injector layshaft, at the left front corner of the engine and is accessible when standing at the engine control panel. It may be used to shut engine down manually, or to bring the engine speed to idle, as when taking an engine "off the line." It is also used to increase engine speed gradually when putting an engine "on the

line," when locomotive is under power.

134 **Indicators, Gauges and Protective Devices**

After the engines are started the entire operation of the locomotive may be conducted from the cab. Protective devices, alarm bells, and signal lights are installed in the locomotive to provide the maximum protection for the equipment.

There are a number of indicators, gauges, and protective devices which should be observed when inspecting the engine room. Additional protective devices and indicators are installed in the locomotive which should be checked when abnormal operation (trouble) is encountered.

135 Engine Overspeed Trip If the engine speed exceeds approximately 910 RPM, an engine overspeed device, located on the front of the engine behind the engine governor, see Fig. 5-10, Section 5, will trip and bring the engine to a stop.

136 Hand Brake The hand brake is located in the engine room, to the right of the air compressors of both the "A" and "B" units. To set brakes with foot pedal, hold foot pedal down and turn the wheel as far as it will go. To release the brakes, advance the wheel enough to release the foot pedal latch and let go of the wheel. On brakes without foot pedal, rotate wheel in release direction against the friction locks. Before moving the locomotive, be sure the brakes are completely released. Whenever anyone is working around the locomotive trucks, the hand brakes should be applied.

SECTION 2

NORMAL OPERATION

Successful road operation and dependable function of all F7 locomotive components are entirely dependent upon the quality of inspection and repair at regular maintenance periods, as well as the proficiency of the operating crew. As a supplement to terminal maintenance a "pre-service check" by the engine crew upon boarding the locomotive, will generally preclude the necessity of anyone entering the engine room while under way.

It is strongly recommended that the items listed below be checked thoroughly and without omission, for carelessness is most often the cause of road failures which cause unnecessary delays.

PRELIMINARY

200 When Boarding the Locomotive

- A. Inspect exterior of locomotive and running gear for:
1. Liquids leaking from the locomotive.
 2. Loose or dragging parts.
 3. Proper positioning of Angle Cocks and Shut-Off Valves.
 4. Observe brake cylinder piston travel, if air brakes are set.
- B. In the engine room with engines running (if engines are not running, see Art. 300 for starting instructions), the following check is to be made in all units.
1. Check for oil, water and fuel leaks.
 2. Check gauges, indicators and switches as listed in Fig. 2-1.

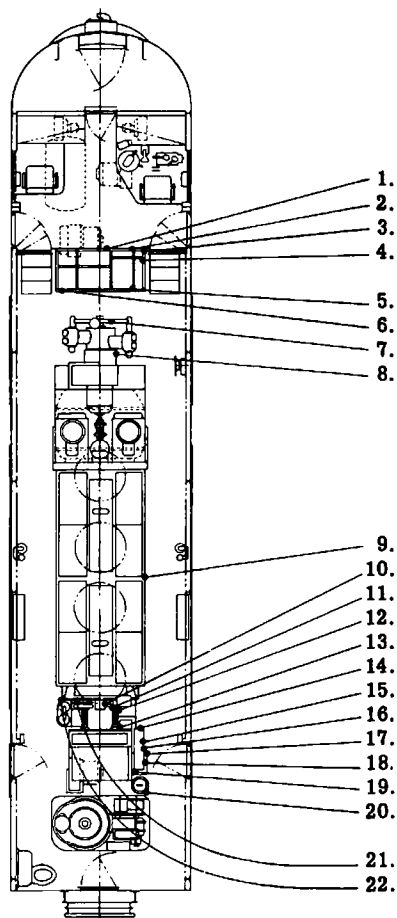

Location Of Gauges Relays And Equipment

Fig. 2-1

ENGINE ROOM CHECK CHART

Item	Reading		Ref. Art. No.	Unit Failure Check
	Idle	800 RPM		
1. Aux. Gen. Ammeter	20	20+	318	B
2. Starting Contactors	Not Stuck St. Position		319	X
3. Control Air Pressure	80 ± 3		320	X
4. Battery Ammeter	0 or +	0 or +		
5. Ground Relay	Yellow		322	X
6. Main Reservoir	130 to 140			
7. Air Comp. Intercooler	30# When Pumping			
8. Air Comp. Oil Pres.	5#	15#		

FAILURE CHECK. Should a unit fail to perform properly check items lettered as "X." The letters R, B, YB, indicate items that will cause Red, Blue, or Yellow and Blue lights to come on. See Art. 311 for details.

9. Lube Oil Level	Run Level		401	
10. Eng. Speed & Fuel Ind	Needles as in Fig. 8-11		323	X
11. Gov. Oil Level	Between Lines			
12. Water Pressure	0 to 5	25 to 35		R
13. Water Temperature	125° Min.	165° ± 15°	400	R
14. Isolation Switch	"RUN"		324	X
15. Lube Oil Pressure	6# Min.	30# to 45#	129	YB
16. Fuel Supply	As Needed			Y
17. Load Regulator	Same as other units		325	X
18. Lube Oil Suction	Green		129	YB
19. Water Level	Between Lines		400	R
20. Gen. Water Supply	As Needed			
21. Overspeed Trip	Latched (Pull to Set)		327	B
22. Fuel Flow	Thru Glass Nearer Engine		326	X

Fig. 2-1

3. Check position of transition cutout switches. They should be pinned or sealed in the position in which the locomotive is to be operated, all in "MAN" or all in "AUTO."
4. Drain condensation from air brake system.
5. Check position of "Controlled Emergency Cock" on the D-24 control valves in all "B" units. The position of this cock should correspond with the setting of the Rotair valve in the operating cab, either "FRGHT" or "PASS."
6. In cab of trailing "A" unit, set Rotair valve in proper "LAP" position and see that brake valve is properly cut out.
7. When returning back through each unit, check and release hand brake in each unit.

NOTE: It is good practice to check battery ammeter in the distribution panel on each unit to see that the auxiliary generator is charging.

C. In the cab

1. Check brake valve cut-out cock and Rotair valve position ("FRGT" or "PASS" as desired — "PASS" recommended for running light).

If a locomotive is to be run light for a considerable distance, or with a short freight train, the Rotair valve in the trailing cab should be placed in "PASS LAP," the "Controlled Emergency Cut-Out Cock" on the control valves of the "B" units and the Rotair valve in the operating cab should be placed in "PASS" position to insure quick acting emergency on locomotive units.

With long freight trains the above valves should be placed in "FRGT LAP" on trailing "A" unit,

and in "FRGT " on "B" units and operating "A" unit, which will effect a controlled emergency action on each locomotive unit.

The controlled emergency action can be nullified (on operating "A" unit only) at any time quick acting emergency is required by placing the independent brake valve in full application position in addition to full emergency position of the automatic brake valve.

2. Install reverse lever, move to desired direction, either "forward" or "reverse."

The reversing switch (in the electrical control cabinet) will move to the opposite direction when the reverse lever is moved, if the transition lever is in "Off" position only.

When the transition lever is in Run 1 position, the reversing switch will not move to the opposite direction when the reverse lever is moved until after the throttle is opened.

3. Place manual transition lever in No. 1 position. To move transition lever, lift as high as it will go, and press firmly in direction you desire to move the lever. Maintain this side pressure and lower the lever, it will slip into the next notch.
4. If locomotive is equipped with dynamic brake, check position of unit selector switch to correspond with number of units of locomotive.
5. Push in "Generator Field" switch.

201 **Handling Light Locomotives**

- A. Running light (Complete cab preparation Art. 200, Item C)
 1. Place foot on safety control foot pedal.
 2. Release independent brake.

3. Open throttle one notch at a time. To open throttle, jerk it gently one notch and release. This will permit the lever to set itself for the next notch.
4. NOTE THAT THE LOCOMOTIVE ROLLS FREELY AND CARE SHOULD BE USED IN JUDGING THE SPEED.
5. Close throttle to idle before setting brake.
6. Locomotive must be standing still at the time the reverse lever is moved.

B. Coupling to train

1. Locomotive must not be moved with air hoses hanging free on nose of "A" units.
2. In backing onto a train it may be desirable to use the attendant's call in rear "A" unit or train signal whistle valves at rear of "A" and "B" units for signalling.
3. Valves and cocks.
 - a. Nose angle cock is behind pilot on fireman's side.
 - b. Steam line valve behind pilot on engineer's side (Pilot plate must be removed to connect steam line).
 - c. Train line signal whistle shut-off valve in nose compartment directly ahead of engineer. It is on signal line reducing valve at front center of brake rack.

C. Pumping up air

1. Pull out generator field switch.
2. Place reverser in neutral
3. Open throttle to 4th, 5th, or 6th notch as needed.

202 **Splitting and Joining Units**

1. Take down all jumpers (inside and outside the diaphragm).
2. Close angle cocks on both units on all air hoses.

3. Break hoses and separate units by uncoupling.
4. In joining units.
 - a. Stretch units to insure couplers are locked.
 - b. Connect hoses and jumpers, and be sure all angle cocks on all air hoses are opened in both units.
 - c. CUT OUT BRAKES, AND ALL CONTROL SWITCHES IN ALL BUT THE OPERATING UNIT. Remove reverse lever in trailing "A" unit.

HANDLING A TRAIN

203 **Starting** (recheck cab preparations, Art. 200, Item C).

FREIGHT

It would be practically impossible to write definite instructions for train starting that would apply to all conditions and at all times.

It will be noticed that the locomotive does not respond as soon as the throttle is opened. In fact, it may take several seconds before the locomotive will start to move. This is due to the fact that the load regulator arm is resting in the minimum position. By this it is meant that the total amount of resistance is in the generator battery field circuit, reducing the generator field excitation to a minimum.

As the throttle is opened above run one, the pilot valve in the engine governor becomes unbalanced, causing engine lube oil to flow to the vane motor of the load regulator, causing the arm to move toward the maximum position. As the arm moves towards maximum, resistance is cut out of the generator battery field circuit, increasing the generator excitation, increasing generator output to start the locomotive or train.

Locomotives, when delivered, are adjusted so that the increase of power output is controlled by the load regulator and governor rather than by the throttle. Thus, although the throttle lever is opened rapidly, the rate of power increase will be controlled by the load regulator and governor, and a smooth start assured.

If the train does not start on the first attempt, it may be found necessary to take slack, making sure that all brakes are released. Actual tests on 100 car trains have shown that as much as 9 minutes may be required to completely release the brakes, although this is an unusual condition. Damaged couplers may result from haste.

When train has moved far enough for all slack to be taken up, it is desirable practice to open throttle to attain desired speed as soon as practicable.

As a heavy train starts to move, the indicator pointer will probably be in the overload (yellow) area. As the pointer stops moving to the right and starts back to the left, open throttle another notch. Continue in this manner until in Run 8 or the desired speed has been attained.

Starting Freight (1 or 2 unit locomotives)

1. Place foot on safety control pedal and release brakes.
2. Open throttle quickly to Run 4 and observe load indicating meter pointer move to the right.
 - a. If train has started moving when pointer passes 825 amperes, reduce throttle one notch.
 - b. If train is not moving when pointer passes 825 amperes advance throttle one notch. Immediately after train starts to move, drop throttle two notches to avoid slipping.

- c. With train moving, advance throttle one notch each time hand moves to left until Run 8 or desired speed for movement is reached.
- d. Should wheels slip in starting or accelerating train, drop throttle one or more notches before sanding.
- e. In starting a train, going above Run 5 will only result in violent wheel slippage.

Freight (3 or 4 unit locomotives)

Same as procedure for 1 or 2 units, except throttle is opened rapidly to Run 3 instead of Run 4.

PASSENGER (1 or more units)

Same as procedure for 1 or 2 units (freight) except throttle is opened rapidly to Run 3 instead of Run 4. Since passenger trains start easier than long freight trains, reducing throttle one or two notches will not be necessary, unless slipping occurs.

In starting passenger trains it is necessary to consider the weight of the train, the amount of slack, the condition of the rails, and the demands of the schedule.

Full scale readings on load indicating meter are permissible on above starts. However, indicating pointer must continue moving to the left as train accelerates and must be at 825 amperes or less before any of the short time amperage ratings are exceeded.

204 **Accelerating a Train**

1. After the throttle is in the 8th notch, the indicating meter pointer should move slowly toward the left. If the pointer is in the overload area, it must continue to move until it is in the green area, or the locomotive is overloaded. Operation in the overload area

can continue for only the time indicated on the plate below the indicating meter. See Art. 309 and Fig. 1-2.

2. If the train speed continues to accelerate, the pointer on the load indicating meter will cross the space between area No. 1 and area No. 2.
 - a. If the locomotive is being operated in automatic transition, the transition lever is left in the number 1 position as long as the locomotive is under power. All normal steps of transition forward and backward are made automatically with the throttle in Run 8 without any attention on the part of the engineman.
 - b. If the locomotive is being operated in manual transition, the engineman must move the transition lever to the number 2 position. The lever must again be advanced when the pointer crosses the space into area number 3 and again for area number 4. When closing throttle for slow down or stop, the pointer will swing to the left because engine and generator load have been reduced. Do not advance transition lever at this time. The transition lever should be advanced only when throttle is in Run 8 position, with one exception. In the event a train is started at the top of a long down grade, with transition lever in No. 1 position. The train speed will increase, while the engine throttle is in a reduced position. Before opening throttle at bottom of grade, the transition lever should be advanced to the transition position corresponding with the train speed.

NOTE: When transferring from 2 to 3 or 3 to 2, the throttle must be reduced to Run 6. After trans-

ition has been made, the throttle is opened again to Run 8. To prevent losing train speed, shift should take three to five seconds, to effect a smooth and proper transition.

205 **Slowing Down Because of a Grade**

1. As the train slows down on a grade the pointer on the indicating meter will move slowly toward the right.
 - a. If the locomotive is being operated in automatic transition, backward transition will take place automatically.
 - b. If the locomotive is being operated in manual transition, the transition lever must immediately be moved to the corresponding position after the pointer has moved across the space from one area to the next.

BRAKING

206 **Air Braking with Power** Under certain conditions it may be desirable to keep the train stretched during a slow down or stop. If this is done the throttle should be closed to at least the 6th notch and the independent brake kept fully released. As the train speed decreases, the throttle must be eased off. As the train slows down, the pulling power of the locomotive increases rapidly and might become great enough to part the train if the throttle is not reduced. The throttle should be in "idle" before the locomotive comes to a dead stop.

207 **Dynamic Braking** To use the dynamic brake see that the unit selector switch located next to the instrument panel is set to correspond with the number of units in the locomotive consist. Place the throttle in "idle," wait at least 10 seconds, and move

the transition lever to "off." (The reverse lever must be in either forward or reverse to operate dynamic brake.) When using dynamic brakes, the reverse lever **MUST** be in the direction in which the locomotive is moving. If the reverse lever is in opposite direction to which locomotive is moving, the brake will be just as effective, but the current generated by the traction motors will flow through the transition indicator in the opposite direction with possible damage to the meter. As the pointer on the meter will move backward, no indication of braking effort will be shown on the scale of the meter.

If the train is moving at considerable speed, enough brake may be developed in the "off" position to bunch the slack. If necessary, move the lever to "B" and wait until slack is bunched. The dynamic brake is, in effect, an independent brake and the indicating meter is now acting as a "brake cylinder pressure gauge."

The same precaution must be used in controlling slack as with the independent brake of the locomotive. After the slack is bunched the lever may be moved to give the desired amount of brake. The pointer must not be carried beyond the red triangle on the indicating meter (**THIS SHOULD NOT BE CONFUSED WITH RED DIAMOND**), nor must the dynamic brake warning light be permitted to stay lit. In either case, ease off slightly on the brake until these conditions are remedied.

Differences in idling speed of the engines and variation in the motor and generator characteristics may cause the dynamic brake warning light to come on before the meter pointer reaches the red triangle, but in any case, the light must not be on. The light is an indication of an overload, and operating with it "on" might damage the traction motors and braking grids.

The independent brake must be kept fully released at all times when the dynamic brake is in use, or the wheels may slide. As the speed decreases below 10 miles per hour the dynamic brake becomes less effective. When the speed further decreases it is permissible to completely release the dynamic brake by placing the transition lever in "No. 1" position, and apply the independent brake simultaneously to prevent the slack from running out.

Whenever desirable the automatic brake may be used in conjunction with the dynamic brake provided the independent brake is **KEPT FULLY RELEASED**.

The most effective use of the dynamic brake is between 15 and 25 miles per hour depending on the gear ratio. Speed on grades should not be allowed to "creep up" by careless handling of the brake, as this is a holding brake and is not effective for slowing down heavy trains on steep grades.

MISCELLANEOUS OPERATING INSTRUCTIONS

208 Operation over Railroad Crossings When crossing railroad crossings, reduce throttle to the 5th notch before reaching crossing and leave reduced until all units are over crossing in order to reduce arcing from the brushes to the motor commutator.

210 Changing Operating Ends When the consist of the locomotive includes two "A" units, the following procedures should be followed in changing from one operating end to the opposite end:

1. If the locomotive is equipped with electro-pneumatic brakes and the brake has been in use, change the brake selector on the auto-

- matic brake valve to "AUTO," and open electro-pneumatic brake switch.
2. REMOVE REVERSE LEVER.
 3. With safety control foot pedal depressed, release independent air brake by placing independent brake valve handle in "release" position.
 4. Make full service automatic brake reduction.
 5. Close brake pipe cut-out cock and release safety control foot pedal.
 6. Move the rotair valve to the proper "LAP" position.
 7. Move the automatic brake valve handle to "RUNNING" position and remove the handle from the brake valve.
 8. Remove the independent brake valve handle in "release" position.
 9. Open all switches in control push-button box and lock switches in off position.
 10. Proceed to cab at opposite end. Check "PC" switch and reset if necessary. Open switch lock on control push-button switch box, close control and fuel pump switches and such other switches as are necessary.
 11. Insert reverse lever, automatic brake valve and independent brake valve handles. Place independent brake valve in "full application" position.
 12. Move the Rotair valve to the proper operating position.
 13. Open brake valve cutout cock (double heading cock) slowly, pausing from five to ten seconds in mid-position.
 14. When ready to move locomotive, depress safety control foot pedal or automatic brake valve handle and move the independent brake valve to "RELEASE" position.

211 Operating a "B" Unit with Hostler's Controls

Operation at the hostler station is the same as an "A" unit. The push button switches are beside the controller. The brake valve cutout cock is below the brake valve. The bell valve is a globe valve near the controller. Only No. 1 transition is available. Movement of the reverse lever automatically places the locomotive in No. 1 transition. It is to be remembered that the operation of the "B" unit controls will operate all units joined to it.

When securing the hostler control be sure all push buttons are pulled out, the controller and reverser pinned, and the brake valve cut out, as these items will affect operation at any other station or cab.

212 Leaving Locomotive Officials of the Mechanical

Department of the various railroads generally issue instructions of this nature that will apply to their own individual requirements, as conditions will vary with each different railroad, and in a good many instances between different localities on the same railroad.

213 Air Box Drains Each engine has two air box

drain tanks incorporated in the engine oil pan near the generator end, one on each side. These tanks have a valve in the drain line so that the tanks may be drained when the locomotive is standing still, and sludge and oil from the tank will not be carried onto the running gear. In the event that the drain tank becomes filled, a tell-tale hole in the tank will blow the overflowing sludge and water onto the engine-room floor. If water appears in the tell-tale hole the cause should be investigated.

214 Unusual Operating Conditions Unusual Oper-

ating Conditions such as overloading, running through water, failure of indicating meter, isolating units etc., are covered in Section 3.

SECTION 3

SPECIAL CONDITIONS AND PROBLEMS DURING OPERATION

There are several conditions which may be encountered from time to time which require special operating instructions. If the instructions are closely followed no damage to the equipment will result. Careless operation under these specialized conditions can be very costly.

300 Starting Engines

1. Close all switches in distribution panel.
2. At engineman's station close "control" and "fuel pump" switches.
3. Place independent brake in full "application" position.
4. Check "PC" switch.
5. **BE SURE REVERSER LEVER IS REMOVED FROM CONTROL STAND.**
6. Check engine lube oil and water levels and oil level in governor and air compressor.
7. Test signal alarm system by placing isolation switch in "Run" position momentarily. Blue light should light and bells should ring.
8. If engine has been shut down more than two hours, open cylinder test valves, pull lay shaft closed and press "START" button on engine control panel. Crank engine over a few revolutions. If water was discharged from cylinders investigate, if not, close test valves and proceed.
9. Turn on fuel pump switch and check for fuel flow through sight glass on fuel filter nearest engine (mounted on the right front of engine).
10. Check setting of overspeed trip (pull to set).
11. Check governor oil alarm trip button.
12. Hold layshaft one quarter open.

13. Press engine start button until engine starts (not more than fifteen seconds).
 14. Check oil pressure.
 15. Check ground relay.
 16. Check starting contactor interlocks.
 17. Idle engine until water temperature comes up to green area on gauge before working engine.
 18. Place isolation switch in "Run" position (down).
 19. For starting troubles, see Section 5.
- 301 **Stopping Engine** (For stopping while under power, see Art. 314).
1. Place isolation switch in "start" position.
 2. Push engine "stop" button in and hold it until engine stops.
 3. Place fuel pump switch in "off" position.
 4. Open cylinder test valves on engine (if more than two hour layover).
- 302 **Securing Locomotive at Engineman's Control Station in Preparation for Layover**
1. Place transition lever in "off" position.
 2. Place reverse lever in "neutral" position and remove lever from controller.
 3. Open all switches in push button control box and distribution panel (after engine has been stopped).
 4. Release air brakes and set hand brake. As an added precaution against locomotive moving, block the wheels.
- 304 **Freezing Weather Precautions** In freezing weather, precautions must be taken to see that water in the locomotive does not freeze. If No. 1 engine is shut down, but train line steam is available, open steam admission valves into engine and "G" valve on cooling water supply tank. The steam admission valve is located on engine room floor at left front corner (governor end) of engine. Do not confuse this valve

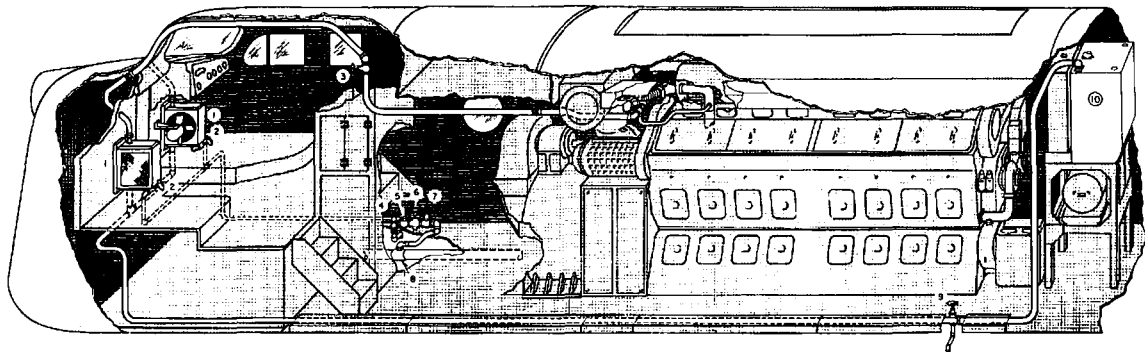

- | | |
|---------------------------------------|----------------------------------|
| 1. Cab Heaters | 6. Steam Pressure Reducing Valve |
| 2. Cab Heater Steam Valves (+) | 7. Steam Admission Valve (+) |
| 3. Cab Heater Valve | 8. Steam Trainline Connection |
| 4. Steam Heating Line Drain Valve (+) | 9. Cab Heater Drain Valve (+) |
| 5. Check Valve | 10. Engine Cooling Water Tank |
- (+) Normally Closed

Cab Heating System
Fig. 3-1

with the engine drain valve. Close valve 3 and open valves 2 and 7, Fig. 3-1. Valve 4 should be closed, valve 9 cracked open to allow condensate to drain. If train line steam is not available, the entire system will have to be drained. Steam admission valves are provided on the following equipment, so that if engine and steam generator are inoperative, steam from an external source may be supplied to prevent freezing.

Steam Generator (These valves should be opened)

1. Heating coil valve.
2. Water suction line valve.
3. Water tank valve.

For detailed instructions, see Steam Generator Section.

Engine Cooling System (These valves should be opened)

1. Steam admission valve to engine cooling water.
2. Valve for steam supply to cab heaters.
3. Toilet water tank valve.
4. "G" valve.

In freezing weather if heating facilities are not available, all water must be drained from locomotive.

1. Engine cooling system and cab heaters. See Fig. 3-1.
2. Steam Generator. (See Steam Generator Section)
3. Steam Generator water tank.
4. Toilet water tank.
5. "G" valve.
6. Air system.
 - a. Air compressor oil separator.
 - b. Upper sump reservoir.
 - c. Lower sump reservoir.
 - d. No. 2 main reservoir under cab floor.
 - e. Type H filter.
 - f. Electrical control air regulator.
 - g. Electrical control air reservoir.
 - h. Strainers at engine control and instrument panel, and electrical control cabinet.
 - i. Air compressor intercooler.

305 Towing Locomotive

1. Be sure reverse lever is in neutral position. If locomotive is to be towed in a train any appreciable distance, the reverser switch must be placed in neutral and locked in that position. To lock the reverser switch, remove the locking pin which during normal operation is screwed into the left hand side of the reverser housing. With the reverse lever in neutral, punch the buttons on top of reverser switch lightly, to center. (If control air is not available, place wrench on square portion of switch shaft and center switch manually.) After switch has been centered, shut off control air. Insert pin into hole in the right side of reverser housing, pushing pin all the way through the reverser switch shaft, and screw pin into threaded hole on left side of reverser housing.
2. All isolation switches must be in "START" position. If it is necessary to keep the engines idling for any reason while towing locomotive, the fuel pump and control switches should be left in the closed position.
3. The air brake equipment should be set according to the air brake manufacturer's bulletin.

306 Operating without Transition and Load Indicating

Meter (Manual Operation) Transition should be made in accordance with reading of transition meter and should never be made from speed indicator reading, except when the transition meter fails to function.

If at any time the transition meter does not function properly, or the lead unit has been isolated, transition should be made by reference to locomotive speed. The table shows the approximate speeds in miles per hour with 40" wheels at which transition should occur at full throttle.

		GEAR RATIO								
From Pos.	To Pos.	65/12	62/15	61/16	60/17	59/18	58/19	57/20	56/21	
1	2	14.5	19.0	20.5	22.5	24.0	26.0	27.5	29.5	
2	3	19.0	24.5	26.5	29.0	31.0	33.5	36.0	38.5	
3	4	40.0	52.0	56.5	61.0	65.5	70.5	75.0	80.5	
4	3	40.0	52.0	56.5	61.0	65.5	70.5	75.0	80.5	
3	2	19.0	24.5	26.5	29.0	31.0	33.5	36.0	38.5	
2	1	14.5	19.0	20.5	22.5	24.0	26.0	27.5	29.5	

307 **Operating with Steam Locomotive as Helper**

In moving large tonnage trains over heavy grades ordinarily encountered in mountainous territories, steam locomotives are generally used for helper service. In such a movement, it must be known that the steam locomotive can and will pull, as its share of the load, the tonnage of the train which is in excess of the maximum continuous tonnage rating of the Diesel locomotive for the grade over which the train is moved. The steam locomotive must be capable of pulling its share of the tonnage without danger of slipping.

Steam locomotives used as helpers often have tonnage ratings based on speeds lower than the continuous rated speed of the Diesel locomotive. Above such speeds, the Diesel locomotive will absorb more than its proportionate share of the load since its tonnage rating is based on a higher speed. As a result, the Diesel locomotive may become overloaded in endeavoring to gain the minimum speed for its continuous rating. This will be indicated by the transition indicating meter pointer moving to the right of the No. 1 green area into the overload area.

Under these conditions, reduce the Diesel locomotive throttle, allowing the train speed to drop and the steam locomotive to pick up its proper share of the tonnage. As the speed decreases, the transition indicating meter pointer will move to the right. In this event reduce the throttle until the pointer reaches the No. 1 green area. When the pointer remains in

the green area the steam locomotive will have assumed enough tonnage to remove the overload from the Diesel locomotive. Operation should be continued at this throttle position. It is permissible to operate Diesel locomotives at full throttle to get over a grade as quickly as possible, provided the TIME of overload is not exceeded. Locomotives should never be operated continuously, below the 5th throttle position.

Should the transition meter be out of order, it will be necessary to handle the throttle by reference to the speed indicator instead of the transition indicating meter. In this case, the table of "approximate continuous speed ratings" given below should be used. To apply this data in the table, reduce the throttle notch by notch. After each throttle reduction, allow the train speed to become steady and read the speed indicator. Compare the reading with the figure in the table opposite the throttle position being used and in the column corresponding to the gear ratio of the locomotive. If the train speed is lower than the table figure, reduce the throttle another notch and repeat the procedure, comparing the speed with the line in the table for the new throttle position. Continue the throttle reduction until the train speed becomes equal to or higher than the table speed reading. Continue operation at this throttle position.

Approximate Continuous Speed Ratings
Miles Per Hour With 40" Wheels

Throttle	65/12	62/15	61/16	60/17	59/18	59/19	57/20	56/21
8	9.0	11.0	12.0	13.5	15.0	15.5	17.0	18.0
7	7.5	9.5	10.5	11.0	12.0	13.0	14.0	15.0
6	5.5	7.0	7.5	8.0	8.5	9.5	10.0	11.0
5	3.5	4.5	5.0	5.5	5.5	6.0	6.5	7.0

An example of the use of the table is given below:

Assume the locomotive is one with 62/15 gear ratio. When operating in transition number 1 and

throttle in run 8, with a helper locomotive, the train speeds drops to 10 m.p.h. This is under the 11.0m.p.h. shown in the table for a 62/15 gear ratio locomotive in throttle run 8. The locomotive is overloaded, and if the transition indicating meter were working the pointer would be to the right of No. 1 green area (825 amp.). The throttle is then reduced to run 7. The speed drops to 8.5 m.p.h. and the helper locomotive assumes more load. The locomotive is still overloaded since the table shows 9.5 m.p.h. for run 7. The throttle is next moved to run 6. The speed becomes steady at 7 m.p.h. This checks with the continuous speed rating in the table and operation should be continued with the throttle in this position.

308 Operating with Diesel Locomotive as Helper

A number of Diesel locomotives with 12-tooth pinions are being used in pusher or helper service. Whenever a locomotive with 12-tooth pinion is used as a pusher or helper for another locomotive having 15-tooth or larger pinions, the throttle on the 15-tooth (or larger) pinion locomotive should be handled in the same manner as when a steam locomotive helper is used. It is very desirable, as in all railroad operations, to get a train over the hill in as short a time as possible, but before the TIME of overload operation is exceeded, the throttle should be reduced on the locomotive with the larger pinion gears to reduce its load, putting more of the load on the locomotive with the smaller pinion. In this manner, the indicator pointer will be brought back into the safe operating zone.

At this time, the engineman on the 12-tooth pinion locomotive will have to watch his transition indicating meter to be sure his locomotive is not overloaded. If the pointer of the 12-tooth locomotive is in the overload zone, but the top of the hill is within the indicated mileage or time limit of the overload zone in which he is operating, it will be permissible to proceed, in

order to get over the hill in as short a time as possible, but if the TIME of overload operation is exceeded, train tonnage should be reduced. This instruction applies to any combination of locomotives with different gear ratios.

If slipping occurs, reduce throttle below the slipping point and operate sander, again opening throttle after sanders are in operation. SAND SHOULD BE USED TO PREVENT SLIPPING, NOT TO STOP IT.

309 **Operating in Short Time Overload Zone**

When starting a train, the pointer of the transition indicating meter will usually move temporarily into the short time overload section of the meter. This represents a normal condition if the pointer returns to the No. 1 green area as the train speed increases. If the pointer remains in the overload area or enters this section of the meter on a grade with the transition lever in No. 1 position, the locomotive is overloaded.

The locomotive is designed to stand overload operation if this condition does not exceed certain limits. The greater the overload the further the pointer swings over into the overload area and the less time the locomotive can operate without the motors heating excessively.

310 Tonnage and Speed Ratings The tonnage ratings of any F7 locomotive depends on number of units, grade, and gear ratio between the pinion on each traction motor and the axle gear with which it meshes. The table below lists tonnages for various horse power ratings and gear ratios, and also shows the approximate speed which the locomotive will develop when hauling its rated tonnage. The maximum permissible operating speed of the locomotive for each gear ratio is also given. This represents the road speed at which the traction motors will turn at the maximum safe RPM.

These minimum speeds listed below **MUST NOT** be used for rating the tonnage, but only as a guide to approximate the running speed with rated tonnage.

With the listed tonnage ratings, all engines must be up to full rated output. If an engine is low in power, or an engine is "off the line," the tonnage should be adjusted in proportion to the decreased power.

**CONTINUOUS TONNAGE RATING FIGURES
FOR F7 LOCOMOTIVE**

GEAR RATIO

HP	GRADE	65/12	62/15	61/16	60/17	59/18	58/19	57/20	56/21
6000	1.0%	7380	6000	5510	5000	4620	4260	3920	3610
6000	1.5%	5120	4140	3790	3440	3160	2920	2690	2470
6000	2.0%	3860	3100	2830	2550	2350	2160	1970	1800
4500	1.0%	5540	4500	4130	3750	3460	3200	2940	2710
4500	1.5%	3830	3100	2850	2570	2370	2190	2010	1840
4500	2.0%	2900	2320	2120	1910	1760	1620	1480	1350
3000	1.0%	3690	3000	2760	2500	2310	2130	1960	1810
3000	1.5%	2560	2070	1900	1720	1580	1460	1340	1320
3000	2.0%	1940	1560	1420	1280	1180	1080	980	900
1500	1.0%	1840	1500	1380	1250	1150	1070	980	900
1500	1.5%	1270	1030	950	860	790	730	670	610
1500	2.0%	970	780	710	640	590	540	490	450

Approximate Minimum Speed For Above Rating

9.0 11.0 12.0 13.5 15.0 15.5 17.0 18.0

Maximum Speed 50 65 71 77 83 89 95 102

NOTE: F7 locomotives with 65/12 gear ratio and D27 motors, or D7-D17 motors using armatures wound with the new silicone coils, will be permitted to operate at 55 MPH maximum speed. All other motors 50 MPH maximum speed.

In order to avoid overloading the electrical equipment, it is important that the tonnage of the train be kept within the maximum tonnage rating limits of the locomotive except where **SPECIAL TONNAGE RATING** has been supplied to the railroads by the locomotive manufacturer.

PROBLEMS DURING OPERATION

311 If Alarm Bells Ring An alarm signal light will be lighted in the unit affected:

RED Engine water temperature over 208° at outlet (approximately 200° on gauge). Check water level, shutters and fans. If condition cannot be corrected at once isolate engine and investigate for cause. If the fuel pump motor fuse in the engine control panel is blown, the fuel pump will stop and cooling system fan and shutter control will be inoperative. Air supply shut off valve for shutters is mounted on left wall of carbody opposite engine blower.

YELLOW & BLUE Low lube oil pressure or high lube oil suction. Engine will be stopped. Isolate engine and reset governor trip button to stop alarm bells. Check oil level and condition. If no difficulty is evident start engine, check oil pressure. Place engine on line. Watch oil pressure and suction gauge. Under extremely high temperatures an otherwise normal engine may have oil pressure fall low enough to trip the alarm.

BLUE Alternator failure (whenever engine stops while "on the line" this light will light, since stopping engine, of course, stops the alternator). Check overspeed trip and fuel flow, start engine and attempt to put engine "on the line." If light comes on instantly, or if light lights with engine running, check auxiliary generator field fuse and alternator field fuse. If light does not come on, after engine is started, but engine will not respond to throttle, check ground relay. See Art. 322.

GREEN Steam generator failure. See Section 6

NOTE: The yellow lube oil alarm light will burn when-

ever the governor low oil alarm switch is tripped whether isolation switch is in "start" or "run" position. The "low oil" alarm light and "alternator failure" lights are energized through the fuel pump control circuit so that if the "PC" switch is tripped or the fuel pump switch in the cab pulled out or the fuel pump fuse in the operating unit is blown these alarms will not operate.

312 If Locomotive Fails (All Units) to Produce Power with Engines Running If engines are stopped, start engine. See Art. 300.

1. Check "control," "generator field," and "fuel pump" switches and position of reverse lever.
2. Check "PC" switch (tell tale pin should be down or indicating light not burning).
3. Check control fuses. Move throttle to "STOP" position, if engines begin to die, quickly return throttle to "idle." If engines do not slow down check the two control fuses in distribution panel.
4. Check brakes.
5. If trouble still persists, check each unit.

NOTE: If locomotive is putting out power, output of "A" unit can be read directly from load indicating meter. Throttle response can be told by sound of engine. Both are important observations.

313 If Any Unit Fails to Produce Power with Engine Running If engine is stopped check over-speed trip lever, and fuel flow, and low oil pressure trip on governor, then start engine or see Art. 300.

1. Refer to Fig. 2-1, Section 2, and check each item under "Unit failures check" for proper setting and reading.
2. Check battery field fuse on low voltage panel.
3. Check control jumpers between units, they may be loose or contacts dirty or burned.
4. A careful check of these items will reveal the more common difficulties (75% of the troubles).

An unusual difficulty requires careful study of the particular situation.

Any piece of mechanical equipment is subject to some difficulties. An arrangement of protective devices is provided on these locomotives to prevent damage in case of a failure or careless operation. **OVERLOADING IS ONE EXCEPTION AND IS ENTIRELY THE RESPONSIBILITY OF THE ENGINEMAN.** As soon as it is apparent that the tonnage is too great, the engineman must take the proper steps to reduce train tonnage.

In cases of serious difficulty in a unit the engine should be immediately isolated and an investigation made.

314 Isolating and Stopping an Engine while Under Power or Using Dynamic Brake

(For normal stopping procedure, see Art. 301).

If it becomes necessary to take engine "off the line" while the locomotive is operating under power, it should be done as follows:

1. Pull manual control lever shut. Hold until engine stops.
2. When bell starts ringing place the isolation switch in the "start" position.
3. Place fuel pump switch in "OFF" position.

315 Starting and Placing Engine on the Line while Locomotive Is Under Power

1. Start engine in the usual way. (See Art.300).
2. After lubricating oil pressure builds up, place isolation switch in "run" position. If throttle is above third position, hold off on governor to injector linkage with layshaft manual control lever, to allow engine to come up to speed gradually. **DO NOT** place an engine "on the line" when using dynamic brake. See Art. 326.

SPECIFIC DIFFICULTIES**316 Recovery of Control of Brake after Penalty Application**

1. Place automatic brake valve in "LAP."
 2. Close throttle to idle.
 3. Place foot on safety control foot pedal.
 - *4. Wait until application pipe builds up to main reservoir pressure. (Listen for exhaust or watch PC switch light - if used).
 5. Reset train control.
 6. Check PC switch.
 7. Release brakes.
- * If "PC" will not reset with automatic brake valve handle in "Lap," after an emergency application, place brake valve handle in running position.

317 Setting "PC" Switch Recover brake, see Art. 316. If "PC" switch is tripped locomotive will have power in number one throttle position (shown on load indicating meter) but engine speed will not advance as throttle is opened. Fuel pumps will be stopped. In No. 5 or No. 6 throttle position the engines will stop. No bells will ring. The "fuel pump" switch in the cab open and the fuel pump fuse in the distribution panel blown will cause the same difficulty as a tripped "PC" switch.

318 Auxiliary Generator Charging Rate Failure of auxiliary generator will stop excitation of alternator and cause a blue light. Normal output should keep battery ammeter at 0 or show some charge. Auxiliary generator ammeter can show 20-30 amperes charge and still have 150 ampere output fuse blown. In case of auxiliary generator failure stop engine in that unit and check 30 ampere field fuse and 150 ampere output fuse.

319 Starting Contactors Main contact points must not stick closed. The interlock located underneath main contactor must be closed and making good contact. If interlocks do not close or make contact, engine will speed up when throttle is opened but will not load. Above No. 5 throttle position the fuel indicator on the governor will be unbalanced to minimum fuel (low power piston) and load regulator will point toward 5 o'clock.

320 Control Air Control air should be 80 ± 3 lbs. to supply air to close main contactors and other air operated accessories. Failure of control air will stop power output as main contactors will not close. Engines will speed up in response to throttle. Above No. 5 throttle position, the fuel indicator will be unbalanced to minimum fuel (low power piston) and load regulator will point toward 5 o'clock. See Art. 327.

321 Battery Ammeter Battery ammeter should always show 0 or some charge. If discharge is indicated check auxiliary generator output. If trouble cannot be remedied anticipate failure as battery runs down.

322 Ground Relay Pointer points to yellow dot when set, red dot when relay is tripped. When the ground relay is tripped the engine will not speed up when throttle is opened. In No. 5 or No. 6 throttle position engine will stop and blue light will light. To reset, isolate engine, reset relay, and put engine on line. If relay continues to trip isolate unit, Art. 324.

323 Wheel Slip Relay The wheel slip relay is located in the electrical control cabinet, behind the power contactors. If one pair of wheels should slip while locomotive is under power, this relay will pick up, lighting the wheel slip light intermittently as the wheels slip, stop slipping and slip again, to warn the

engineman. The throttle should be reduced to stop the slipping, and sand applied to prevent further slipping when throttle is reopened.

324 **Alarm Indications For One Pair Of Wheels**

Sliding If one pair of wheels should slide when starting a train, the wheel slip light will flash on and off intermittently, but as the train speed increases, the light will stay on more or less continuously and will not go out when the throttle is reduced and sand applied. The light will go out when throttle is closed to idle.

Under this condition, the engine crew should make an immediate investigation to determine the cause. The wheels may be sliding due to a locked brake, a broken gear tooth wedged between the pinion and ring gear, or a motor bearing may have seized.

Repeated ground relay action, accompanied with unusual noises such as continuous thumping or squealing, or the smell of burning paint or insulation, may be an indication of very serious traction motor trouble that should be investigated at once.

UNDER NO CONDITION OF REPEATED WHEEL SLIP INDICATION OR REPEATED GROUND RELAY ACTION SHOULD A LOCOMOTIVE UNIT OR POWER PLANT BE ISOLATED AND CONTINUED IN SERVICE WITHOUT FIRST MAKING THE ABOVE INVESTIGATION.

325 **Engine Speed and Fuel Indicators** On Governor

There are two pointers on the cover of the governor. One of these pointers indicates the throttle position of the engine and is labeled "speed." The second pointer indicates the position of the power piston in 16ths of an inch and is labeled "fuel." The lower the number on the "fuel scale" the greater the quantity

of fuel which is being injected into the cylinders. In No. 8 throttle "speed" position the fuel indicator needle should read between 5 and 6 if the engine is properly loaded. In general, the two pointers should be checked only in No. 8 throttle position as indications at part throttle may be misleading. If a marked variation is noted the trouble should be investigated. Excessive fuel (lower number on fuel scale) will indicate engine trouble. Minimum fuel will indicate electrical trouble.

326 Isolation Switch Isolation switch must be firmly in "run" (downward) position to obtain power from the unit. The switch should be opened and closed only with engine at idle speed or stopped. Use the manual layshaft lever to bring engine to idle speed or to stop engine when the locomotive is under power or in dynamic braking. Isolation switch should NOT be placed in "RUN" position when other units are in dynamic braking unless it is KNOWN that the transition lever is in "OFF" position. The safest course is to wait until the train has stopped.

327 Load Regulator When operating in No. 8 throttle position the load regulators throughout the locomotive should be in approximately the same position. Extreme unbalance of the load regulator arm in one unit to maximum or minimum field is an indication of difficulty and should be investigated.

If during full throttle operation one unit shows minimum field (arm in 5 o'clock position) trouble may be either mechanical or electrical. If in maximum field (arm in 8 o'clock position) inspect for loss of electrical load.

328 Fuel Flow For proper engine operation, a good flow of fuel (clear and free of bubbles) should be indicated in the fuel return sight glass, located on the duplex filter assembly, nearest the engine.

Normally, a small amount of fuel will leak by the plunger, and come out the small hole in the stand pipe of the by-pass sight glass. If the leakage is enough so the fuel flows out the top of the standpipe, this fact should be reported to maintenance.

If no fuel is flowing through the fuel return sight glass check fuel pump motors and fuel pumps. If pumps in all units are stopped check "PC" switch, fuel pump switch, and fuel pump fuse in distribution panel. (Do not confuse fuel pump fuse and fuel pump motor fuse).

If pump in other units are running, check switch on engine control panel and control switch, 80 ampere control fuse and fuel pump motor fuse in the distribution panel of units affected. If pump is running but no fuel is pumped check fuel supply, emergency fuel cutoff under the unit, or check for a suction leak in piping between tank and pump, also, check for broken or slipping coupling at fuel pump.

329 Overspeed Trip When tripped, fuel is stopped at the injectors and engine can not be started. Whenever an engine is found stopped always check overspeed trip by pulling firmly on the lever (counterclockwise) to be sure it is set. See Fig. 5-10, Sec. 5.

330 Battery Field Fuse There is an 80 ampere fuse in the battery field circuit of each main generator. Should this fuse be blown no power will be developed in the unit affected. The battery field fuse is located on the low voltage panel which is in the electrical control cabinet and is accessible through a door in the rear wall of the operating cab, and from inspection platform in "B" unit.

331 Running through Water Under ABSOLUTELY no circumstances should the locomotive pass through water which is deep enough to touch the bottom of the traction motor frames. When passing through

water, always go at a very low speed (2 to 3 miles per hour). Water any deeper than three inches above the top of the rails is likely to cause damage to the traction motors.

332 Operation of F7 Locomotives with F 3, FT, or F 2 Units

In many instances it may be desirable to operate combinations of FT, F2, F3 and F7 units in a locomotive. This is an acceptable practice provided gear ratios are the same, and will be entirely successful if the instructions below are followed. No change in operating technique is necessary except for the conditions listed.

Be very careful when operating F7 units in conjunction with other units. If the F7 unit is in the lead, its transition indicator may show perfectly safe loading for the F7, but remember, FT, F2, and F3 units do not have as high a tonnage rating as the F7 and the F7 transition indicator will not show an overload on trailing units. Tonnage will have to be adjusted for the unit or units with the lowest tonnage rating.

1. Manual transition must be used if all units are not equipped with automatic transition. Be sure all transition cutout switches are set either all in "automatic" or all in "manual."
2. Throttle must be reduced to No. 6 position for 2 to 3 or 3 to 2 transition when operating in manual transition position.

333 Manual Transition Should it become necessary to operate with manual transition, the transition cutout switch marked "Auto-Man" located on the automatic transition panel must be set and pinned in "MAN" position. The automatic transition panel is the top panel on the left side of the electrical control cabinet. Change from automatic to manual transition operation should not be made when under power.

It is no longer necessary to cut out the automatic transition on remaining units just because automatic transition is inoperative on one unit, or if one or more units are not so equipped; but it WILL be necessary to operate the transition lever manually, and at the proper time to effect transition on unit or units in manual position.

The throttle MUST be reduced to Run 6 BEFORE making manual transition from 2 to 3 or 3 to 2. Throttle is again opened to Run 8 after transition has been made.

334 Locomotive Units with Different Gear Ratios

may be operated together ONLY under certain conditions. It is IMPERATIVE that the tonnage be adjusted so the unit geared for the HIGHEST speed is not overloaded by operating below its minimum speed, and the train MUST NOT be operated at a speed higher than the top speed of the lowest geared locomotive.

ELECTRICAL CONTROL CABINET**Location Of Panels**

- A. Voltage Regulator and Starting Contactors
- B. Low Voltage
- C. Automatic Transition
- D. High Voltage Control
- E. Reverser
- F. Traction Motor and Braking Contactors
- G. Dynamic Braking Control
- H. Low Voltage Distribution
- I. Cam-Switch

Detailed views of equipment on each panel are on following pages.

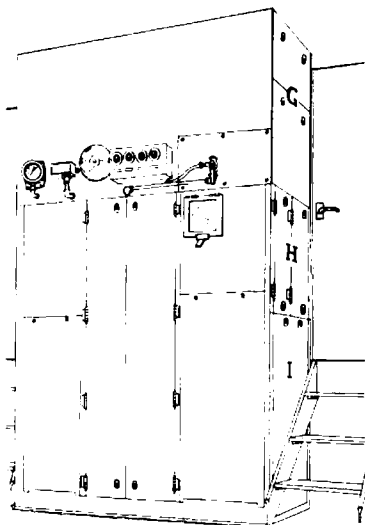

Fig. 3-2a - Engine Room View (Right)

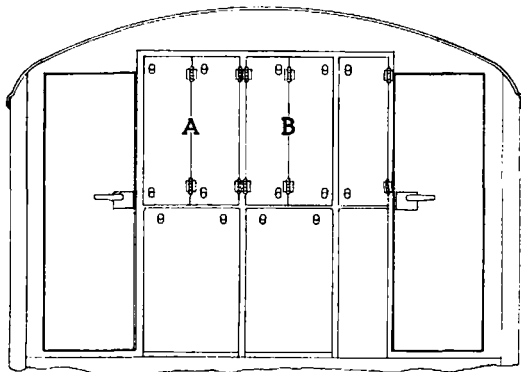

Fig. 3-2b - Cab View

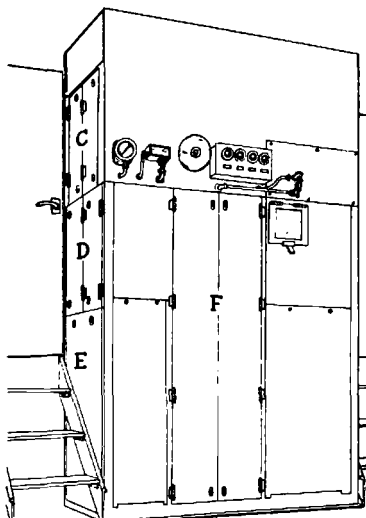
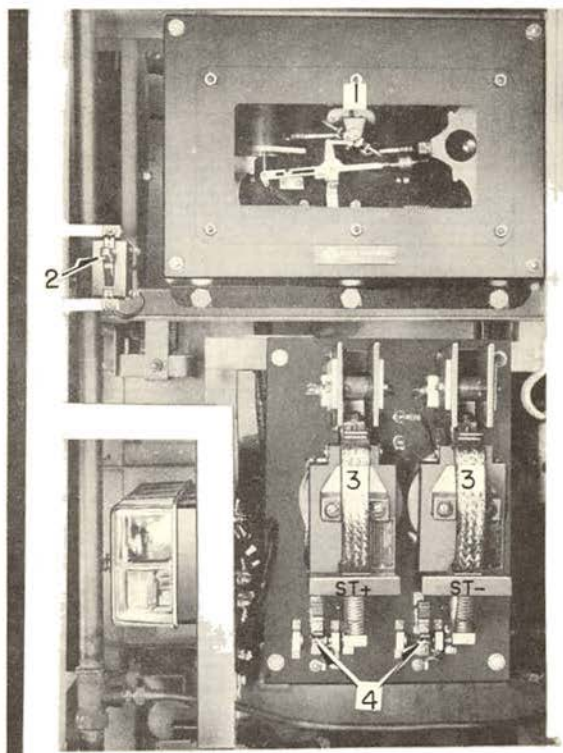
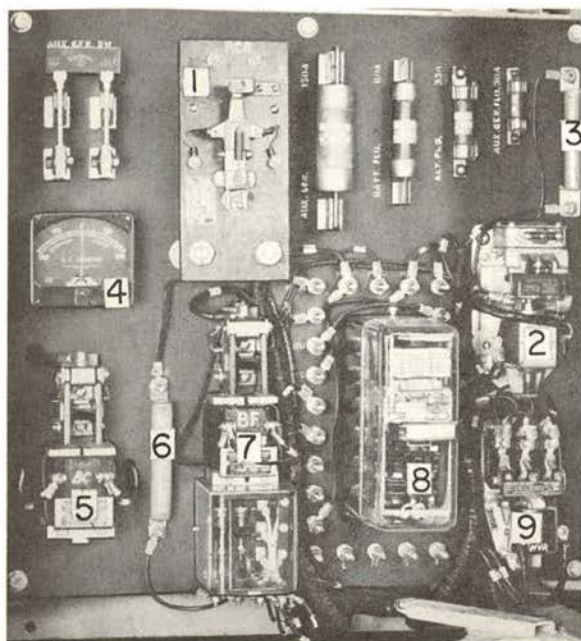

Fig. 3-2c - Engine Room View (Left)



Electrical Control Cabinet
Panel A
Voltage Regulator and Starting Contactor Panels
Fig. 3-3

1. Voltage Regulator
2. Engine Room Light Switch
3. Engine Starting Contactors
4. Starting Contactor Interlocks



Electrical Control Cabinet
 Panel B
 Low Voltage Panel
 Fig. 3-4

1. Reverse Current Relay (RCR)
2. VT Relay
3. Signal Relay Resistor (20 ohm)
4. Auxiliary Generator Ammeter
5. Battery Charging Contactor (BC)
6. Battery Field Discharge Resistor (4 ohm)
7. Battery Field Contactor (BF)
8. Parallel Relay (Auto. Transition Type) (PR)
9. No Voltage Relay (NVR)

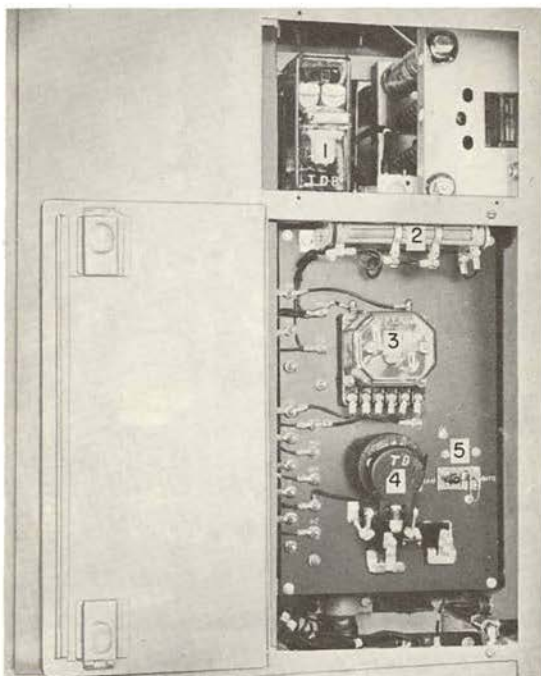

Electrical Control Cabinet
Panel C
Automatic Transition Panel
Fig. 3-5

1. Time Delay Backward Relay (Above Panel)
2. Forward Transition Relay Resistors
(Two - 10,000-Ohm)
3. Forward Transition Relay
4. Time Delay Relay
5. MAN-AUTO Selector Switch

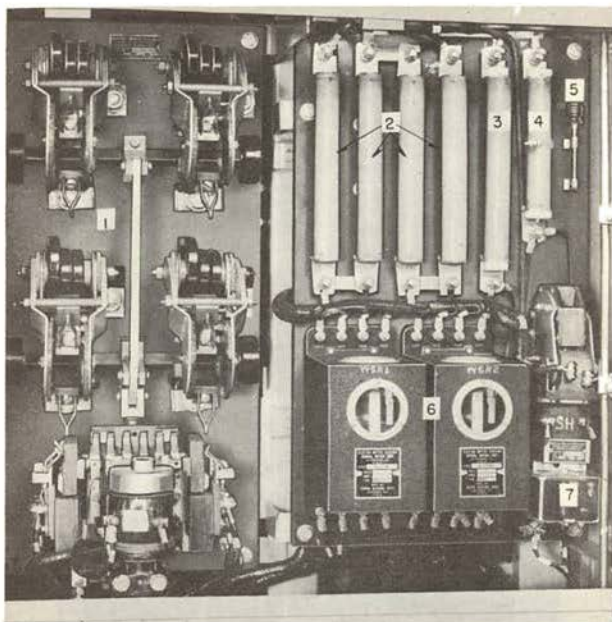

Electrical Control Cabinet
 Panel D
 High Voltage Control Equipment
 Fig. 3-6

1. Traction Motor Field Shunting Contactors (M)
2. 4-2000 Ohm Wheel Slip Relay Resistors
3. 1-400 Ohm Generator Shunt Field Discharge Resistor
4. 35 Ohm Resistor (In SH Operating Coil Circuit)
5. Ground Protective Relay Knife Switch (Sealed)
6. Wheel Slip Relays
7. Generator Shunt Field Contactor

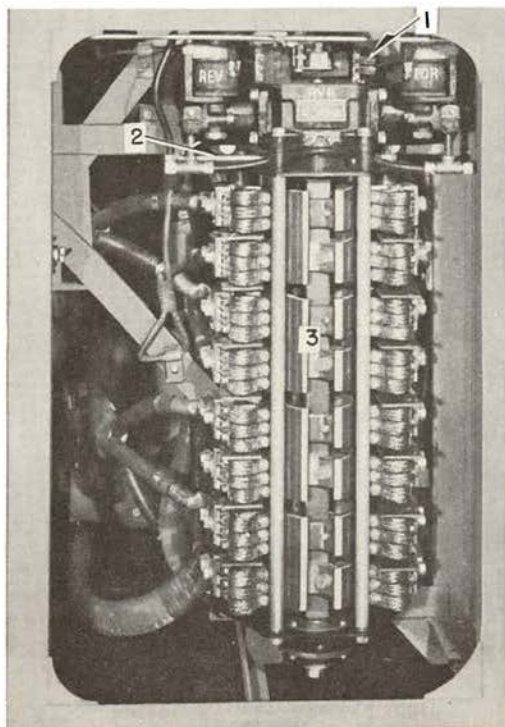

Electrical Control Cabinet
Panel E
Reverser
Fig. 3-7

1. Reverser Interlocks (RVR)
2. Reverser Lock Pin (Unlocked Position)
3. Reverser (Shown in Neutral Position)

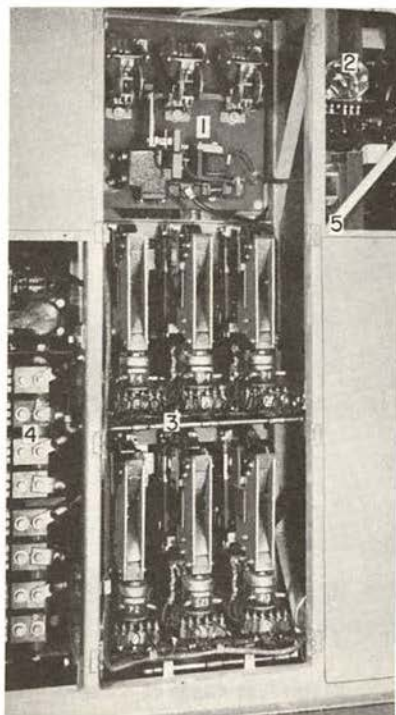

Electrical Control Cabinet
Panel F
Power and Braking Contactors
Fig. 3-8

1. Braking Contactors (B)
2. Ground Protective Relay (GR)
3. Traction Motor Power Contactors (P and S)
4. Reverser (Side View)
5. Brake Warning Relay (BWR)

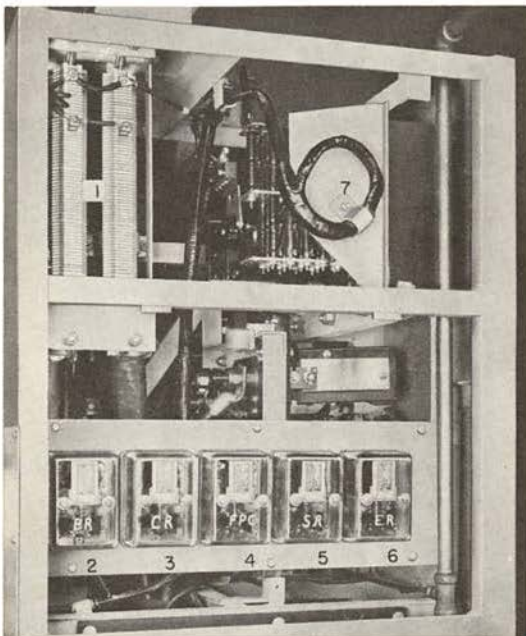

Electrical Control Cabinet
Panel G
Relay Panel
Fig. 3-9

1. Alternator Field Resistor
2. Brake Relay (BR)
3. Air Compressor Relay (CR)
4. Fuel Pump Contactor (FPC)
5. Signal Relay (SR)
6. ER Relay
7. Field Loop Contactor Location - "A" Units Only

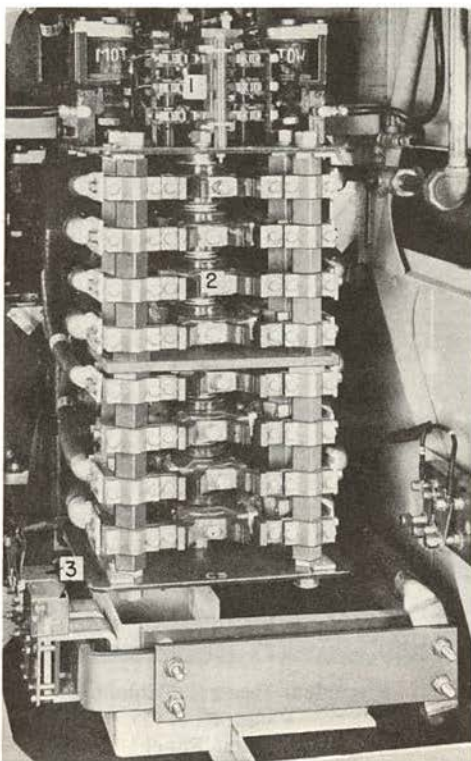

Electrical Control Cabinet
Panel I
Cam-Switch
Fig. 3-11

1. Auxiliary Cam-Switch
2. Cam-Switch
3. Backward Transition Relays - BTS and BTP

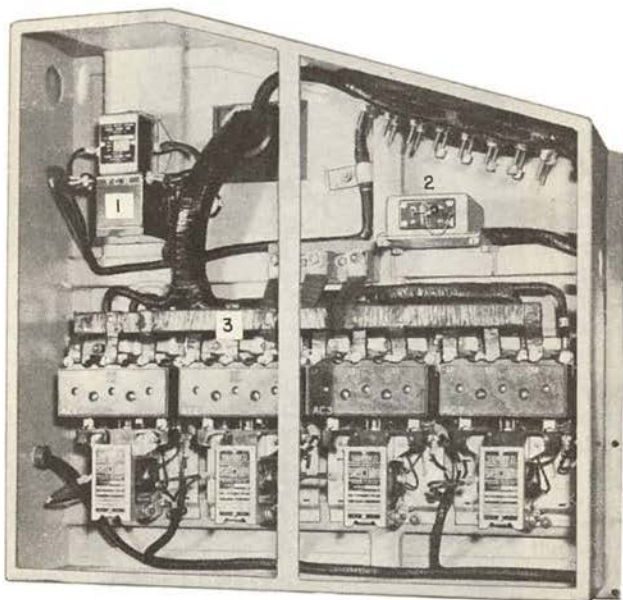

AC Contactor Panel

Fig. 3-12

1. Temperature Control Relay
2. Summer-Winter Switch (SWS)
3. AC Motor Contactors

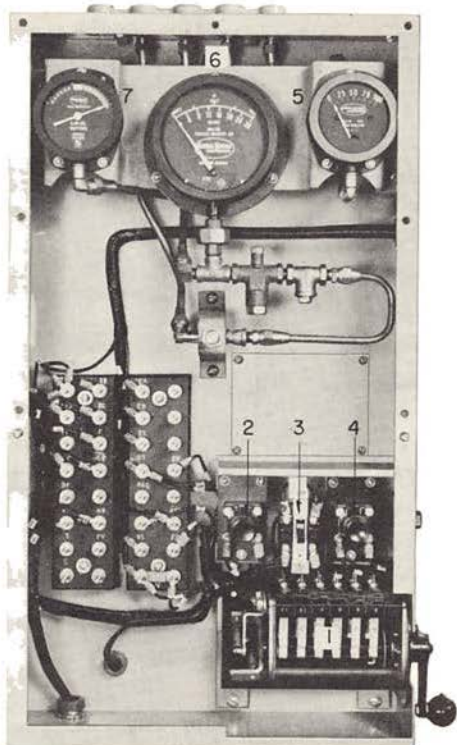

Engine Control and Instrument Panel

Fig. 3-13

1. Isolation Switch
2. Engine "Stop" Button
3. Fuel Pump Motor Switch
4. Engine "Start" Button
5. Lube Oil Pressure Gauge
6. Fuel Oil Gauge (Tank Level)
7. Lube Oil Suction Gauge

SECTION 4

COOLING, LUBRICATING OIL AND FUEL OIL SYSTEMS

COOLING SYSTEM

Water is circulated through the engine radiators and oil coolers by two pumps mounted on the engine. Cooling air through the radiator is controlled by shutters and four electrically driven cooling fans. The operation of the fans and shutters is entirely automatic and under normal conditions will hold the temperature of the engine cooling water so that the gauge on the inlet of left water pump will read in the green area (120° - 190°).

In the event of excessive cooling water temperature the high temperature alarm switch will close causing a red light to show in the unit affected and the alarm bells to ring in all units.

400 Operating Water Level Operating water levels are stenciled on the water tank next to the water gauge glasses to indicate minimum and maximum water levels with engine running and stopped. The engine should never be operated with the water below the low water level. Progressive lowering of the water in the gauge glasses indicates a leak in the cooling system and should be reported.

The system is filled either through the filler pipe located on the roof of the locomotive above the water tank, or through the filler pipe at the rear of the unit on either side.

To fill the system proceed as follows:

1. Stop engine.
2. Open filling level valve "G."
3. Fill slowly until water runs out filling level pipe at valve "G."

4. Close filling level valve "G."

If filling a dry or nearly dry engine also follow these additional steps:

5. Start engine and run several minutes. This will eliminate any air pockets in the system.
6. Shut down engine and open valve "G," and wait 3 minutes.
7. Add water until it runs out filling level pipe.
8. Close filling level valve "G."

If the cooling system of a hot engine has been drained, do not refill immediately with cold water. If this is done, the sudden change in temperature might crack or warp the cylinder liners and heads.

- CAUTION:**
1. Do not attempt to fill the cooling system through the drain pipe located underneath the locomotive.
 2. The system should not be filled above the maximum water level indicated on the water tank.
 - a. To prevent freezing of radiators in winter.
 - b. To prevent loss of rust inhibitor when draining back to "G" valve level.

LUBRICATING OIL SYSTEM

Oil under pressure is forced through the engine for lubrication and piston cooling by the combination piston cooling and lube oil pump. Lube oil which falls into the oil pan is picked up by the scavenging oil pump and forced through the oil filters and cooler to the oil strainer housing where it is ready for recirculation by the oil pump. The excess returns to the oil pan where it is held until used.

401 Oil Level The oil level may be checked with the engine running at any speed and should read between "low" and "full" on either bayonet gauge (one on each side of engine). When the engine is stopped the oil from the filter and cooler will drain back into the oil pan and the level on the dipstick should show "system charged." The mark "system uncharged" is used by maintenance forces when filling oil pan when new oil filter elements are installed.

402 Adding Oil to System When oil is added to the system, it must be poured through the opening having the square cap on top of the strainer housing. Should the round caps be removed while the engine is running, hot oil under pressure will come from the openings and possibly cause personal injury.

When the engine is stopped, all the oil in the cooler core chamber will drain into the strainer chamber and then overflow into the engine oil pan, which will bring the engine oil pan bayonet gauge reading to "system charged." This level is below the "system uncharged" level because some oil is trapped in the lube oil filter, oil lines and engine.

403 Oil Pressure Oil pressure at 800 RPM is normally 35 to 45 pounds. It should not drop below 20 pounds. At idle the pressure should be at least 6 pounds. (In the event of dangerously low oil pressure the engines will automatically be stopped).

FUEL OIL SYSTEM

Fuel in each unit is circulated through the injectors by an electric driven fuel pump. Failure of pump to operate, closed emergency fuel cutoff valve, or clogged strainer can cause fuel failure - See Section 5 of this manual.

404 Filling Fuel Tanks The fuel tanks can be filled from either side of the locomotive at a maximum rate of 250 gallons per minute due to baffles and vents in the tank. Direct reading sight level gauges located on each side of the fuel tank adjoining the fuel fillers indicate level of fuel oil starting at 4-1/2" from the top of the tank and should be observed while filling the tank to prevent overflowing. The fuel should be filtered through a reliable fuel filter before it enters the tank. The fuel capacity of each tank is 1200 gallons. **DO NOT HANDLE FUEL OIL NEAR AN OPEN FLAME.**

405 Fuel Gauge located on engine control and instrument panel in engine room is a direct reading, air operated gauge which indicates quantity of oil in the fuel tank. The gauge does not show fuel level continuously; a push-button needle valve directly below the fuel gauge must be pushed in to get fuel level indication on gauge.

406 Emergency Fuel Cutoff Valve An "Emergency Fuel Cutoff Valve" is provided to cut off the fuel supply to the fuel pump in the event of fire, or any emergency. It is located in the center of the underside of the fuel tank inside a valve compartment on which is a sliding cover. On each side of the locomotive, both "A" and "B" unit, attached to the side skirt, is a small box with a lift cover. Enclosed in this box is a pull ring on the end of the cable running to the fuel cutoff valve. A similar ring is located in the operating cab of each "A" unit, and one on the engineroom wall at the governor end of the engine in each "B" unit.

The fuel cutoff valve can be tripped, and the fuel cut off by pulling any one of these rings. If tripped, the valve underneath the fuel tank must be reset manually.

To reset: crawl under locomotive fuel tank, and slide valve compartment cover to one side. Pull valve stem out and set yoke in place to hold valve open. Close valve compartment cover. See Fig. 5-9 - Sec. 5.

SECTION 5

ON-THE-ROAD TROUBLE-SHOOTING

This section is a reprint of the original issue of the "On-the-Road Trouble Shooting" booklet which has met with much approval among railroad personnel.

It provides a check list calling the Operator's attention to the troubles which are most frequently encountered on the road, and which can be quickly remedied thereby eliminating many delays.

No attempt is made to explain general operation and functions of equipment on the locomotive. For such information refer to the first five sections of this manual.

1. WHAT IS NECESSARY TO MAKE THE LOCOMOTIVE OPERATE?

The following 13 items are essential: Items (a) to (d) in the cab from which you are operating and items (e) to (m) in all units of the locomotive.

- a. "PCS OPEN" light must NOT be burning.
(If light is burning see Question 2, Page 505)

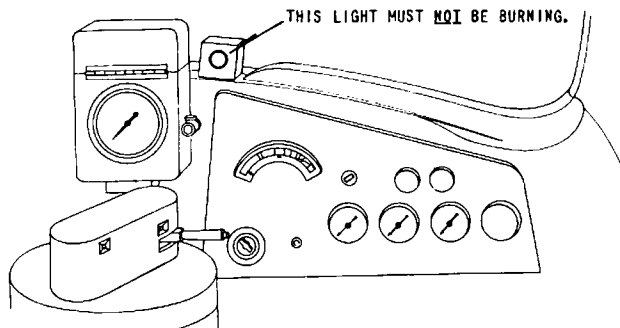

Fig. 5-1

- b. The control, fuel pump, and generator field buttons must be pushed IN in operating cab only. Switches MUST be out and locked at all other control stations.

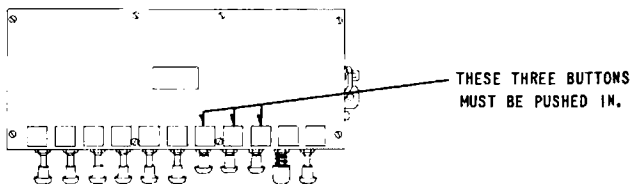

Fig. 5-2

- c. The engineman's reverse lever must be in the forward or reverse position and transition lever in No. 1 position.
- d. All the brakes must be released.
- e. All switches in each distribution panel must be closed (Fig. 5-3).

THE FUSES MARKED "X" SHOULD BE TESTED TO BE SURE THEY ARE GOOD.

IF THIS AMMETER SHOWS A DISCHARGE WHEN ENGINE IS RUNNING, CHECK AUX. GEN. CHARGING FUSE (FIG. 5-8, PAGE 505).

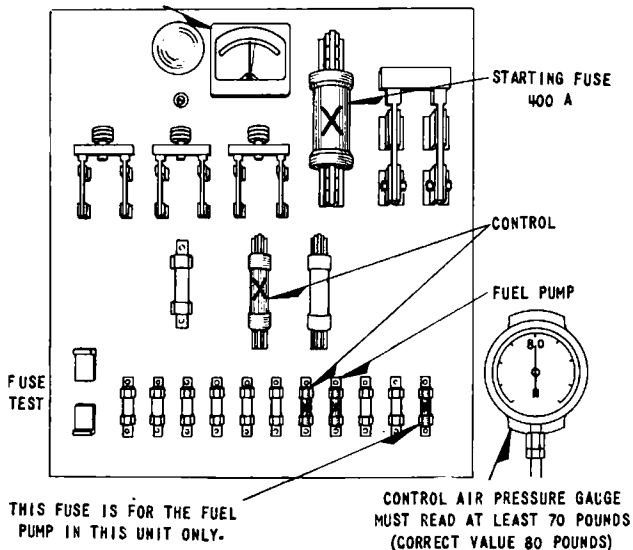

Fig. 5-3

- f. There must be approximately 80 pounds of control air pressure on the gauge next to each distribution panel. (If no pressure or incorrect pressure, see Question 10, Page 510.)

- g. Fuel pumps in all units must be running and fuel flowing through sight glasses. (If not refer to Questions 5 & 6 on Pages 506 & 507.)

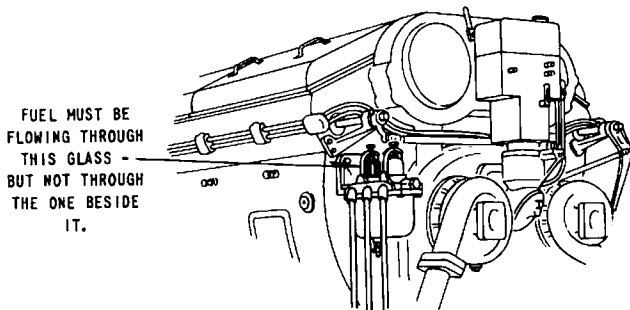

Fig. 5-4

- h. The engines must be running.
(If stopped refer to Question 7, Page 508)
- i. The isolation switches must be in "RUN" position.

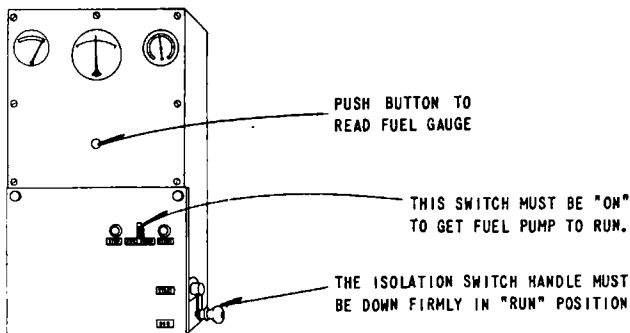

Fig. 5-5

- j. The ground protective relays must be set.
(If tripped to red dot refer to Question 9, Page 510.)

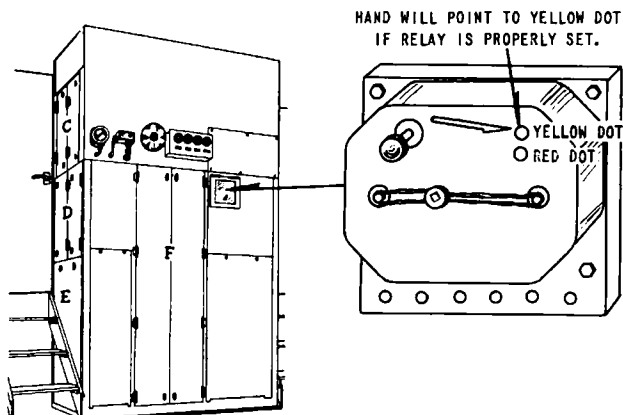

Fig. 5-6

- k. The starting contactors must NOT be stuck closed.

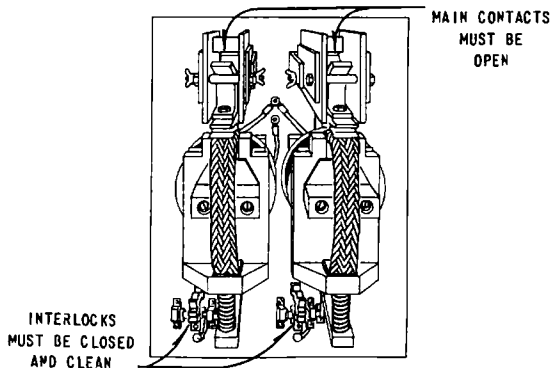

Fig. 5-7

1. Battery field fuses in all units must be good.

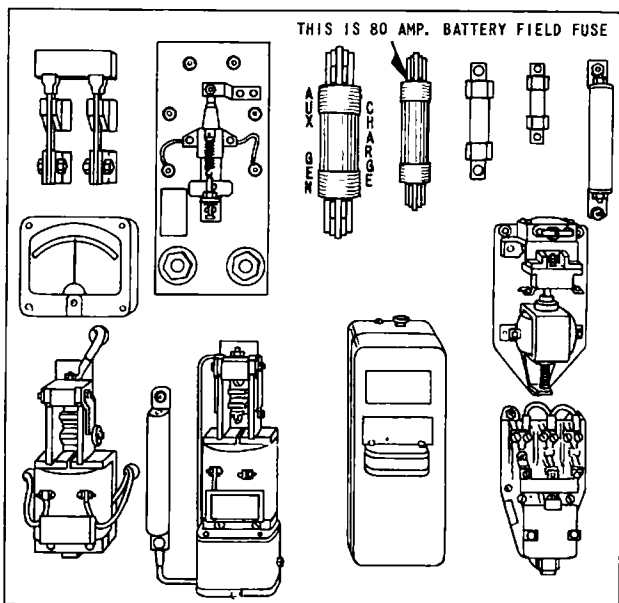

Fig. 5-8

- m. Be sure that all hand brakes are fully released.

2. HOW CAN I MAKE THE "PCSOPEN" LIGHT GO OUT?

The "PCS Open" light is caused to burn only by an emergency or a penalty application of the brakes. By a penalty application, we mean one caused by removing your foot from the safety control foot pedal, overspeeding the locomotive, or application caused by train control devices.

To get the light to go out, a good procedure is to be sure the throttle is in "idle" position and then take whatever steps are necessary to fully release the automatic brake.

If the brakes are applied in "Service," the brake valve may be placed in lap and left there until the light goes out. If there has been an emergency application, the brake valve must be lapped and then moved to running position before the light will go out.

3. IF I DO NOT GET THE "PCS OPEN" LIGHT TO GO OUT WHAT WILL HAPPEN?

Engines will idle for about five minutes, but after that the engines may stop for lack of fuel since when the "PCS Open" light is burning all the fuel pumps in the locomotive are stopped.

4. IF AN ENGINE STOPS WHEN THE "PCS OPEN" LIGHT IS BURNING: WILL THE BLUE LIGHT COME ON AND THE ALARM BELLS RING?

No.

5. IF THE FUEL PUMP IS NOT RUNNING WHAT CAN BE DONE?

Check other pumps in the locomotive to see if they are running. If all the fuel pumps are stopped, check the items shown on Figures 5-1, 5-2 and 5-3 in this section.

If only the fuel pump in one unit is stopped, be sure the switch on the engine control panel (Fig. 5-5) is turned on and the control and fuel pump motor fuses in that unit (see Fig. 5-3) are O.K.

6. IF THE FUEL PUMP IS RUNNING BUT FUEL DOES NOT SHOW IN THE FUEL RETURN SIGHT GLASS (Fig. 5-4) WHAT CAN BE DONE?

If fuel is flowing in the other glass (45 pound) next to the return sight glass, the fuel filters are clogged and nothing can be done on the road.

If no fuel is flowing in either glass, check fuel supply in tank; check to see that the emergency fuel cutoff valve under the locomotive fuel tank has not been tripped (see Fig. 5-9). If this valve is properly set the suction strainers may be clogged and if tools are available, the Wastex may be removed and the filter element replaced without any Wastex.

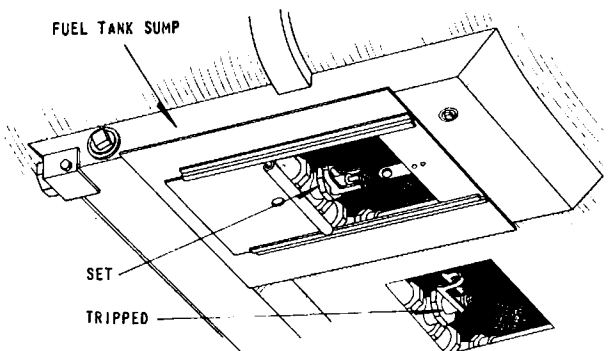

Fig. 5-9

7. IF I FIND AN ENGINE STOPPED WHAT SHALL I DO?

Pull the isolation switch handle up into "START" position (Fig. 5-5). Make certain the switches on the distribution panel in this unit are closed and the fuses good (Fig. 5-3).

Then be sure fuel pump switch is "ON" (Fig. 5-5), and check the fuel return sight glass for a good flow of fuel (Fig. 5-4).

Look at the overspeed trip lever and move it counter-clockwise to be sure it is "set" (Fig. 5-10).

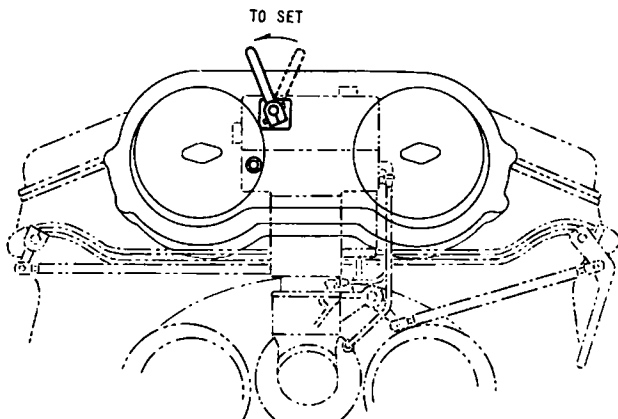
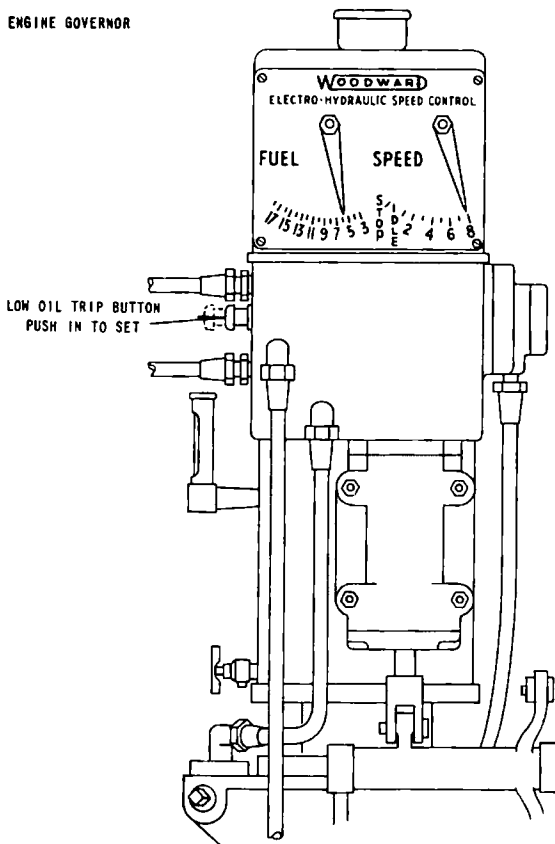

Fig. 5-10

Be sure the low oil pressure trip button on the governor is pushed in so the red part of the shaft is not showing (Fig. 5-11).

Hold the layshaft part way open and start the engine by pressing on the "START" button. Check the ground protective relay (Fig. 5-6) and the starting contactors (Fig. 5-7) and then put the isolation switch down in

"Run" position, if engine throttle is in #2 position or lower. If throttle is in #3 position or higher, hold back on layshaft lever to prevent surge in engine speed.

ENGINE GOVERNOR**Fig. 5-11**

8. HOW CAN I TELL IF AN ENGINE IS PUTTING OUT POWER ?

When the engineer has the throttle in Run 8 pulling a train, the plate on the governor should appear as in Fig. 5-11. If the right hand scale does not read 8 but reads idle, the isolation switch may not be in "RUN" or the ground protective relay may be tripped. If the right hand scale shows 8 but the number on the left hand scale reads 8 to 10, the engine is not loaded and there is probably electrical trouble. Check the battery field fuse; it may be blown (See Fig. 5-8) or the control air (Fig. 5-3) may be low.

If this does not correct the condition, have the engineer reduce the throttle to "idle" momentarily and then return it to Run 8 and check the scales on the governor plate again.

9. HOW IS GROUND PROTECTIVE RELAY SET ?

Isolate the engine, press on ground protective relay set button (Fig. 5-6), then place isolation switch firmly in "RUN" position. If ground protective relay continues to trip, isolate engine and shut down.

10. HOW CAN I GET CONTROL AIR PRESSURE ON GAUGE ?

Control air pressure may be shut off at piping to control air regulator, the regulator may be set too low (turn knob on top clockwise to raise pressure), or air may be shut off at valve in control cabinet. Control air comes from main reservoir so main reservoir pressure must be up. Pressure on gauge should be at least 70 pounds. Control air pressure as high as main reservoir is acceptable in an emergency. The correct setting is 80 pounds.

"Run" position, if engine throttle is in #2 position or lower. If throttle is in #3 position or higher, hold back on layshaft lever to prevent surge in engine speed.

ENGINE GOVERNOR

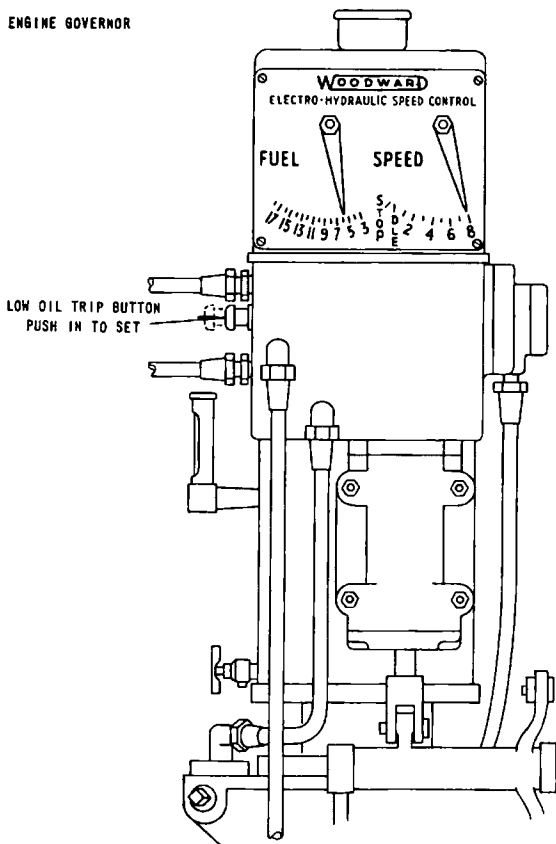

Fig. 5-11

8. HOW CAN I TELL IF AN ENGINE IS PUTTING OUT POWER ?

When the engineer has the throttle in Run 8 pulling a train, the plate on the governor should appear as in Fig. 5-11. If the right hand scale does not read 8 but reads idle, the isolation switch may not be in "RUN" or the ground protective relay may be tripped. If the right hand scale shows 8 but the number on the left hand scale reads 8 to 10, the engine is not loaded and there is probably electrical trouble. Check the battery field fuse; it may be blown (See Fig. 5-8) or the control air (Fig. 5-3) may be low.

If this does not correct the condition, have the engineer reduce the throttle to "idle" momentarily and then return it to Run 8 and check the scales on the governor plate again.

9. HOW IS GROUND PROTECTIVE RELAY SET ?

Isolate the engine, press on ground protective relay set button (Fig. 5-6), then place isolation switch firmly in "RUN" position. If ground protective relay continues to trip, isolate engine and shut down.

10. HOW CAN I GET CONTROL AIR PRESSURE ON GAUGE ?

Control air pressure may be shut off at piping to control air regulator, the regulator may be set too low (turn knob on top clockwise to raise pressure), or air may be shut off at valve in control cabinet. Control air comes from main reservoir so main reservoir pressure must be up. Pressure on gauge should be at least 70 pounds. Control air pressure as high as main reservoir is acceptable in an emergency. The correct setting is 80 pounds.

LOCOMOTIVE TROUBLE SHOOTING CHART

(✓ Indicates Possible Cause of Trouble)

CAUSES OF TROUBLE	SYMPTOMS		
	Engine Stops Suddenly	Engine Goes to Idle	Generator Unloads
Overspeed Trip - - - - -	✓		
PC Switch Tripped - - - - -	✓ (All engines stop eventually)	✓ (All Engines)	
Wheel Slip - - - - -			✓ (Momentarily)
Ground Protective Relay - - - - -	✓ (Run 5 or 6 Only)	✓	✓
Emergency Fuel Cut-Off - - - - -	✓ (Engine stops eventually)		
Low Oil Pressure or High Oil Suction - - - - -	✓		
Isolation Switch - - - - -		✓	✓
Fuses in Control Circuit - - - - -	✓ (All engines stop eventually)	✓	✓
No AC Voltage - - - - -	✓ (Run 5 or 6 Only)	✓ (Blue Light)	
Interlocks in Control Circuit - - - - -			✓
Loss of Control Air - - - - -			✓
Throttle - Emergency Stop - - - - -	✓ (All Engines)		
Jumper Cable - - - - -	✓	✓	✓

Note: Blue Light Signifies Either Alternator Failure or Engine Stopped.

General Arrangement, Drains and Fillers - "A" Unit
 Chart A - Part I

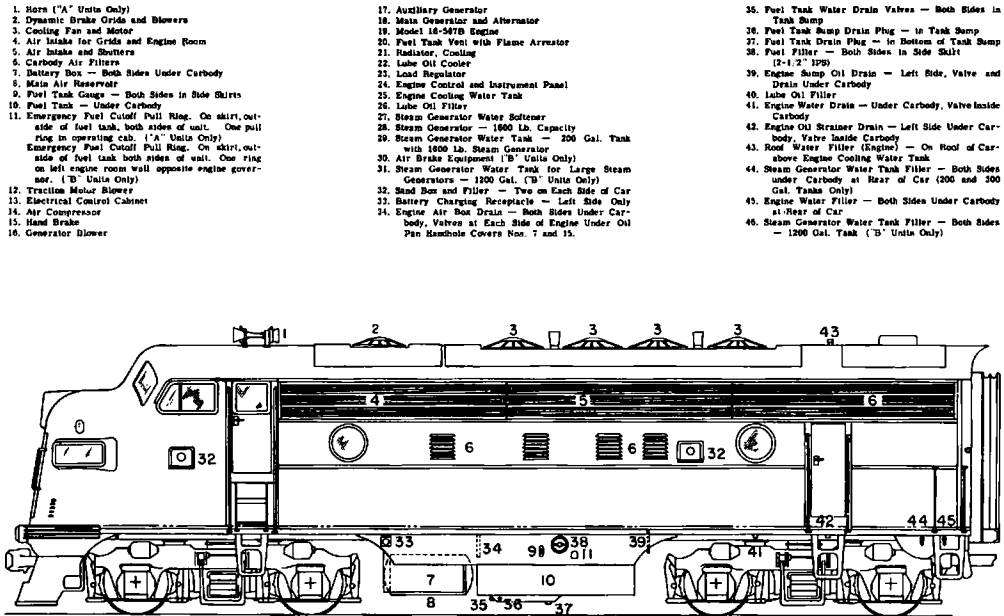

1. Horn ("A" Units Only)
2. Dynamic Brake Grids and Blowers
3. Cooling Fan and Motor
4. Air Intake for Grids and Engine Room
5. Air Intake and Shutters
6. Carbody Air Filters
7. Battery Box - Both Sides Under Carbody
8. Main Air Reservoir
9. Fuel Tank Gauge - Both Sides in Side Skirts
10. Fuel Tank - Under Carbody
11. Emergency Fuel Cutoff Pull Ring. On skirt, outside of fuel tank, both sides of unit. One pull ring in operating cab. ("A" Units Only)
12. Emergency Fuel Cutoff Pull Ring. On skirt, outside of fuel tank both sides of unit. One ring on left engine room wall opposite engine governor. ("B" Units Only)
13. Triction Motor Blowers
14. Electrical Control Cabinet
15. Hand Brake
16. Generator Blower

17. Auxiliary Generator
18. Main Generator and Alternator
19. Model 18-547B Engine
20. Fuel Tank Vent with Flame Arrestor
21. Radiator, Cooling
22. Lube Oil Cooler
23. Load Regulator
24. Engine Control and Instrument Panel
25. Engine Cooling Water Tank
26. Lube Oil Filter
27. Steam Generator Water Softener
28. Steam Generator - 1600 Lb. Capacity
29. Steam Generator Water Tank - 200 Gal. Tank with 1800 Lb. Steam Generator
30. Air Brake Equipment ("B" Units Only)
31. Steam Generator Water Tank for Large Steam Generators - 1200 Gal. ("B" Units Only)
32. Head Box and Filler - Two on Each Side of Car
33. Battery Charging Receptacle - Left Side Only
34. Engine Air Box Drain - Both Sides Under Carbody. Valves at Each Side of Engine Under Oil Pan Handhole Covers Nos. 7 and 15.

35. Fuel Tank Water Drain Valves - Both Sides in Tank Sump
36. Fuel Tank Sump Drain Plug - in Tank Sump
37. Fuel Tank Drain Plug - in Bottom of Tank Sump
38. Fuel Filter - Both Sides in Side Skirt (7-1/2" IPS)
39. Engine Sump Oil Drain - Left Side, Valve and Drain Under Carbody
40. Lube Oil Filter
41. Engine Water Drain - Under Carbody, Valve Inside Carbody
42. Engine Oil Strainer Drain - Left Side Under Carbody, Valve Inside Carbody
43. Roof Water Filter (Engine) - On Roof of Car above Engine Cooling Water Tank
44. Steam Generator Water Tank Filler - Both Sides under Carbody at Rear of Car (200 and 300 Gal. Tanks Only)
45. Engine Water Filler - Both Sides Under Carbody at Rear of Car
46. Steam Generator Water Tank Filler - Both Sides - 1200 Gal. Tank ("B" Units Only)

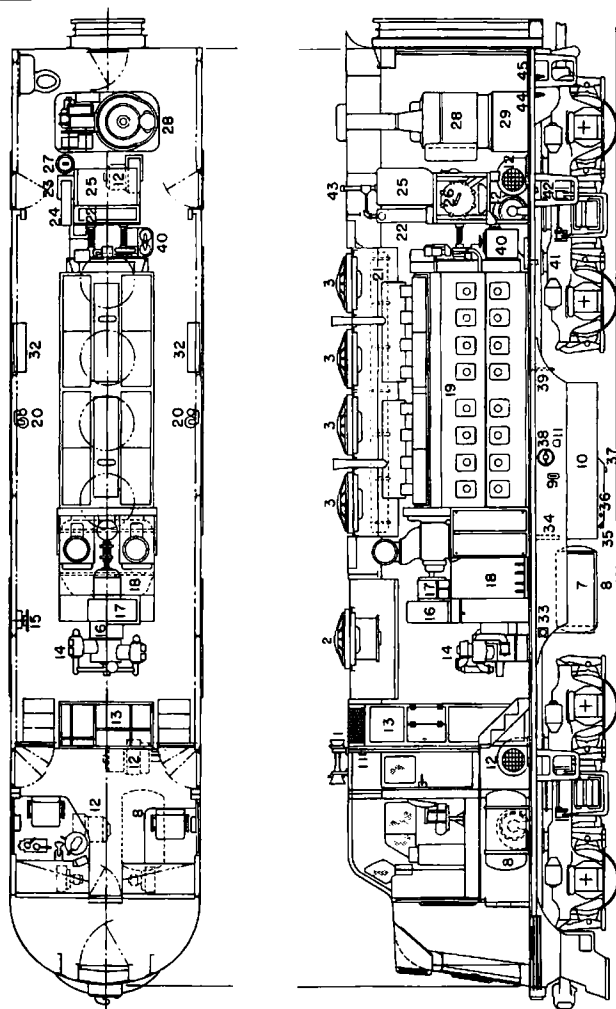

General Arrangement, Drains and Fillers - "A" Unit
 Chart A - Part 2

1. Horn ('A' Units Only)
2. Dynamic Brake Grids and Blowers
3. Cooling Fan and Motor
4. Air Intake for Grids and Engine Room
5. Air Intake and Shutters
6. Carbody Air Filters
7. Battery Box - Both Sides Under Carbody
8. Main Air Reservoir
9. Fuel Tank Gauge - Both Sides in Side Shirts
10. Fuel Tank - Under Carbody
11. Emergency Fuel Cutoff Pull Ring. On skirt, outside of fuel tank, both sides of unit. One pull ring in operating cab. ('A' Units Only)
12. Emergency Fuel Cutoff Pull Ring. On skirt, outside of fuel tank, both sides of unit. One ring on left engine room wall opposite engine governor. ('B' Units Only)
13. Traction Motor Blower
14. Electrical Control Cabinet
15. Air Compressor
16. Generator Blower
17. Auxiliary Generator
18. Main Generator and Alternator
19. Model 18-567B Engine
20. Fuel Tank Vent with Flame Arrestor
21. Radiator, Cooling
22. Lube Oil Cooler
23. Load Regulator
24. Engine Control and Instrument Panel
25. Engine Cooling Water Tank
26. Lube Oil Filler
27. Steam Generator Water Softener
28. Steam Generator - 1800 Lb. Capacity
29. Steam Generator Water Tank - 200 Gal. Tank with 1600 Lb. Steam Generator
30. Air Brake Equipment ('B' Units Only)
31. Steam Generator Water Tank for Large Steam Generators - 1200 Gal. ('B' Units Only)
32. Sand Box and Filler - Two on Each Side of Car
33. Battery Charging Receptacle - Left Side Only
34. Engine Air Box Drain - Both Sides Under Carbody, Valves at Each Side of Engine Under Oil Pan Handhole Covers Nos. 7 and 15
35. Fuel Tank Water Drain Valve - Both Sides in Tank Sump
36. Fuel Tank Sump Drain Plug - in Tank Sump
37. Fuel Tank Drain Plug - in Bottom of Tank Sump
38. Fuel Filler - Both Sides in Side Skirt (5-1/2" I.D.)
39. Engine Pump Oil Drain - Left Side, Valve and Drain Under Carbody
40. Lube Oil Filler
41. Engine Water Drain - Under Carbody, Valve Inside Carbody
42. Engine Oil Strainer Drain - Left Side Under Carbody, Valve Inside Carbody
43. Roof Water Filler (Engine) - On Roof of Car above Engine Cooling Water Tank
44. Steam Generator Water Tank Filler - Both Sides Under Carbody at Rear of Car (200 and 300 Gal. Tanks Only)
45. Engine Water Filler - Both Sides Under Carbody at Rear of Car
46. Steam Generator Water Tank Filler - Both Sides - 1200 Gal. Tank ('B' Units Only)

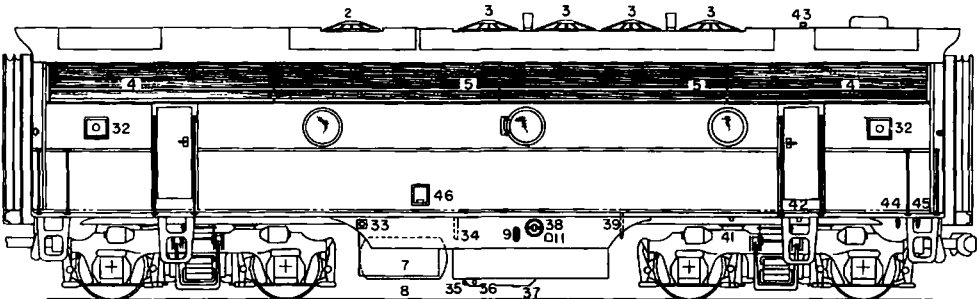

General Arrangement, Drains and Fillers - "B" Unit
Chart B - Part I

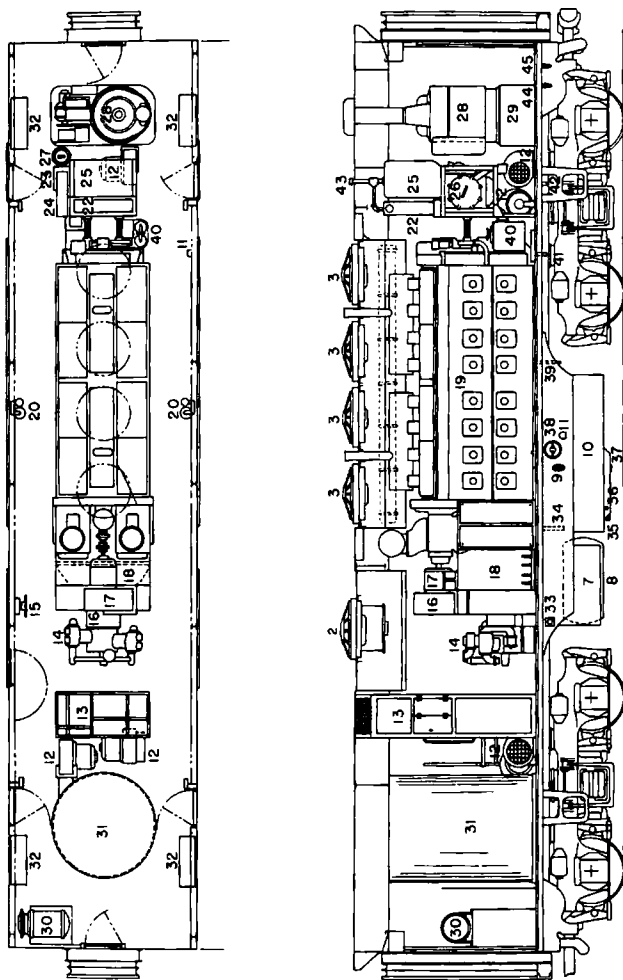

General Arrangement, Drains and Fillers - "B" Unit
Chart B - Part 2

SECTION 6

STEAM GENERATOR

OK-4630, OK-4625, OK-4616

INTRODUCTION

The instructions contained in this section are for the guidance of personnel engaged in the operation of OK series steam generators. A general description of the steam generator is given, the operating technique is outlined and a trouble shooting section is provided for the operator.

The symbol number after each device mentioned in the text refers to the schematic operating chart at the end of this section. The numbers are used to facilitate identification of the various devices.

The chart shows the various controls and devices on the OK series of steam generators and outlines the flow of fuel, water and steam.

DESCRIPTION

Steam generators of the 4630 series have a rated capacity of 3000 pounds of water evaporation per hour; 4625 steam generators have a rated evaporative capacity of 2500 pounds per hour; and 4616 steam generators have a capacity of 1600 pounds per hour. Operation is completely automatic after the steam generator is started, and full operating steam pressure is reached within a few minutes.

The steam generating part of the unit consists of three sets of coiled water tubing, nested and connected in series to form a single tube several hundred feet long. Water is pumped into the coil inlet and con-

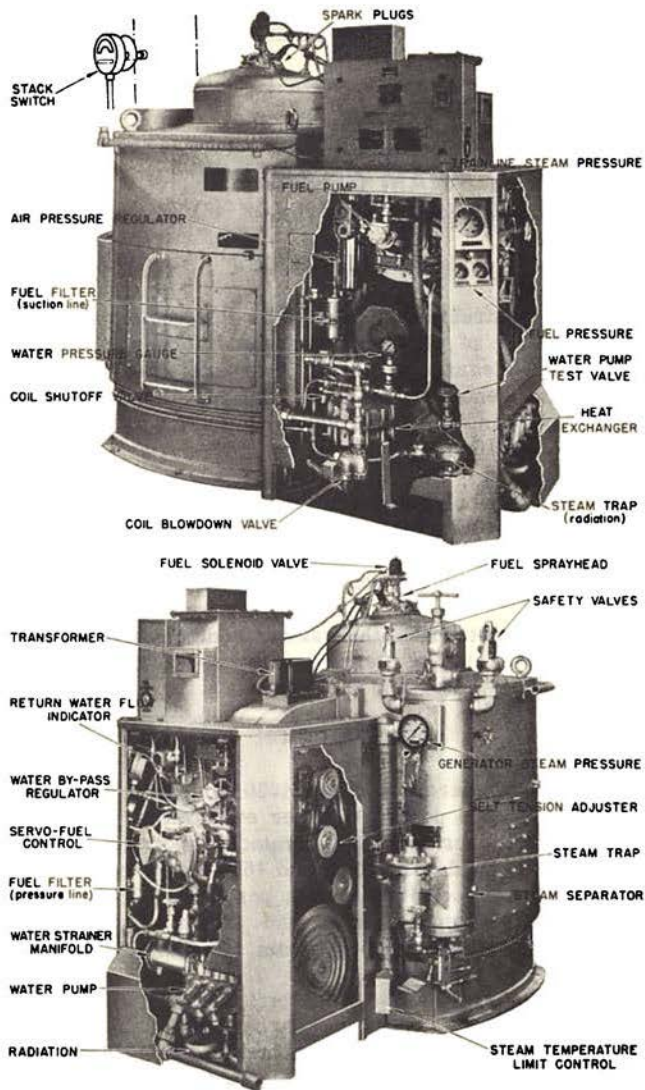

Fig. 6-1 - OK-4360 Vapor-Clarkson Steam Generator

verted to steam as it progresses through the coils. Heat is furnished by the combustion of diesel fuel oil, which is sprayed by compressed air through the atomizing nozzle in the fuel spray head-105 into the firepot above the coils. Here the fine oil spray mixes with air supplied by the blower-202, and is ignited by a continuous electric spark-220. The fire and hot gases flow, first downward, then outward through the nest of coils.

The supply of fuel is regulated to evaporate 90% to 95% of the water pumped through the coils. The excess water flushes scale and sludge from the coils and is carried over with the steam into the steam separator-221, where the water and sludge are removed before the steam flows into the trainline.

The excess water collects in the bottom of the steam separator. Water above the level of the return outlet flows out through a steam trap-223 and through the heat exchanger-213, where it gives up its heat to the incoming feed water. From the heat exchanger the return water flows through return water flow indicator-218 back to the water supply tank-232.

The motor converter-215 drives the blower-202, water pump-230 and fuel pump-209 at a constant speed. The water by-pass regulator-111 automatically controls steam generator output by regulating the amount of water fed to the coils. Before entering the coils, the water passes through servo-fuel control-108, which admits fuel to the spray nozzle in direct proportion to the amount of water entering the coils. The servo-fuel control also adjusts the damper-203 to admit the proper amount of air for efficient combustion of the fuel.

The trainline steam pressure is regulated by adjusting the handwheel on the water by-pass regulator-111. The length of train and the weather conditions determine the setting.

BEFORE STARTING

On OK models, the valves designated by odd numbers must be OPEN during normal operation of the steam generator. Valves designated by even numbers must be CLOSED during normal operation of the steam generator. Normally open valves are fitted with a cross type handle; normally closed valves are fitted with the standard round handle.

1. Make certain that the following valves are OPEN:

Atomizing Air Shutoff Valve-1
Coil Shutoff Valve-3
Return Water Outlet Valve-9
Steam Admission Valve-11 to Trainline Pressure Gauge-224
Steam Admission Valve-13 to Water By-Pass Regulator-111
Three-Way Washout Valve-17
Water By-Pass Regulator Shutoff Valve-19
Water Supply Stop Valve-21

2. Be sure that the following valves are CLOSED:

Coil Blowdown Valve-2
Layover Connection Shutoff Valve-6
Manual Water By-Pass Valve-8
Steam Admission Valve-10 to Radiation-217
Washout Inlet Valves-14 and 16
Water Pump Test Valve-18
Water Drain Valves-20 and 22

3. See that both the overload reset button-106 and the stack switch-109 reset button are "in." The overload reset button is located inside the control panel on the magnetic overload relay.

TO FILL

1. Open the atomizing air shutoff valve-1 and fill-test valve-4; latch open the separator blowdown valve-12 to drain the steam separator. Close the separator blowdown valve when the separator is completely drained.
2. Close the main switch and turn the control switch-102 to FILL.
3. While the coils are filling see that spark-220 is available for ignition. Check ALL valves.
4. When water discharges from the fill-test valve-4 turn the control switch-102 to OFF and close the fill-test valve.

NOTE: If the coils are empty it will take about five minutes to fill the steam generator with water.

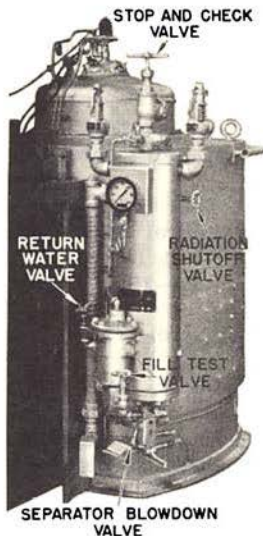

Steam Separator on
OK-4630
Fig. 6-2

TO START

CAUTION: Do not start the steam generator unless the coils are filled.

1. Latch open the separator blowdown valve-12 and turn the control switch-102 to RUN. (For easy starting, be sure the control switch has been OFF

- long enough for the motor to come to a full stop.)
2. Close the separator blowdown valve when the generator steam pressure gauge-212 registers 50 lbs.
 3. Open the separator blowdown valve several times for three to five second intervals during the first few minutes of operation.
 4. Set the water by-pass regulator-111 to the required trainline pressure.
 5. After the trainline is coupled, open the remote control trainline shutoff valve-7 by depressing the reset lever-7a. Then open the stop and check valve-15.

NOTES:

1. Check the return water flow after the steam generator has settled down to a steady output. On 3000 lb. units the return water flow indicator-218 should cycle from 4 to 12 times a minute; on 2500 lb. units it should cycle from 4 to 10 times a minute; and on 1600 lb. units from 4 to 8 times a minute.

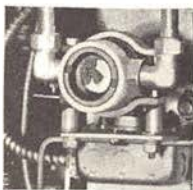

Return Water
Flow Indicator
Fig. 6-3

2. If the steam generator does not start or function properly, check all valves to see that they are open or closed as indicated in the operation chart.
3. The steam generator should come up to full operating pressure in one or two minutes; it may take 10 to 15 minutes to build up the required operating steam pressure in the trainline.

RUNNING ATTENTION

1. Open the separator blowdown valve-12 for five seconds at least once every hour.
2. Turn the handle on the fuel filter-206 during stops. At the same time, turn the handle on the treatment injector filter-225, where this method of water treatment is used.

TO SHUT DOWN THE STEAM GENERATOR

For short stops it is only necessary to close the stop and check valve-15. The fire will cycle and maintain operating pressure in the steam generator. For terminal stops, proceed as follows:

1. Close the stop and check valve-15 and the remote control trainline shutoff valve-7.
2. Set the water by-pass regulator-111 to maximum output. When the generator steam pressure gauge-212 registers 200 lbs. turn the control switch-102 to OFF.
3. Open the coil blowdown valve-2. When the generator pressure drops to 75 lbs. close the valve.
4. Open the separator blowdown valve-12 and blow down the steam separator-221 with the remaining pressure. Close the separator blowdown valve.

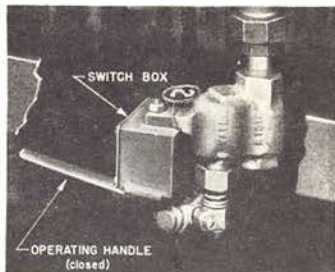

Coil Blowdown Valve
OK-4630
Fig. 6-4

5. Fill the coils with water.
6. Close the atomizing air shutoff valve-1 and open the main switch.

NOTE: When starting, do not omit draining the steam separator, opening the fill-test valve, and again filling the steam generator with water. If the coils are already full, it will only take a moment for water to discharge from the fill-test valve.

FREEZING WEATHER PRECAUTIONS

The inlet valve-10 to the radiation-217 should be opened when operating during severe weather.

If a locomotive with a multiple installation does not have all of its steam generators in operation, open the coil blowdown valve-2, the layover connection shutoff valve-6 and the inlet valve-10 to the radiation on idle steam generators.

CAUTION: Layover connection shutoff valve-6 must be closed when trainline shutoff valve-7 is closed to cut a car out of a train.

If a locomotive is left standing out of service, operate one of the steam generators or make a connection to the yard steam line. In extremely cold weather the water pump-230 and steam generator controls should be given additional protection against freezing.

If no steam at all is available, thoroughly drain the steam generator. Open the drain valves-20 and 22,

the water pump test valve-18, the coil blowdown valve-2, the separator blowdown valve-12 and the coil shutoff valve-3. Break the pipe connections where necessary to completely drain the piping. Turn the water pump by hand to clear it of water, or blow it out with compressed air. Remove the cover of the water treatment or water strainer tank-234 and make sure it is drained.

TROUBLE SHOOTING

If one of the protective switches (magnetic overload relay, coil blowdown valve switch, stack switch high temperature contacts or low temperature contacts) operates to shut down the steam generator, the alarm will ring and the 'boiler off' signal will flash on the remote control panel.

Turn the control switch-102 to OFF and use the following instructions as a guide in locating the trouble.

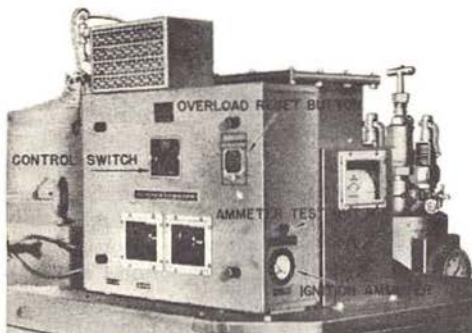

Control Panel on OK-4630
Fig. 6-5

Motor and Burner Shut Down During Operation

1. Blown fuses: The alarm will not ring and the instrument lights will go out. The main fuse (or circuit breaker) is generally located in the low voltage cabinet of the locomotive. Check this fuse, and check the control fuses in the steam generator control cabinet. A test lamp and fuse clips wired inside the control cabinet may be used to check the fuses.
2. Overload reset button-106 "out:" The alarm will ring; the instrument lights will remain on. Turn the control switch-102 OFF; check for hot blower-202 or water pump-230 bearings and for poorly adjusted pulley belts. Check the setting of the belt tension adjuster. Push the overload reset button "in."
3. Stack switch-109 reset button "out:" The high temperature contacts in the stack switch are open; the alarm will ring and the instrument lights will

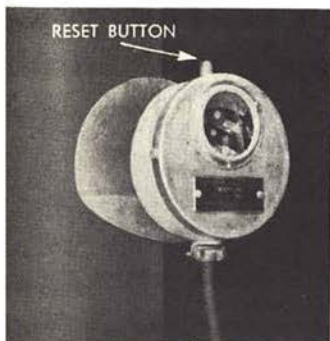

Stack Switch
Fig. 6-6

remain on. Turn the control switch-102 to OFF; open the separator blow-down valve-12 and drain the steam separator-221. Close the separator blow-down valve, push in the stack switch reset button, refill the coils with water, and then start the steam generator.

4. Coil blowdown valve-2 partially open:

The alarm will ring, the instrument lights will remain on. Be sure the locking pin on the coil blowdown valve handle is properly seated in the closed position.

Motor Starts But Burner Does Not

If the fire fails to light, the low temperature contacts on the stack switch-109 will not close, and after a 45 second time delay the outfire relay will open the circuit to shut down the steam generator. The alarm will ring and the instrument lights will remain on. Turn the control switch-102 OFF and check the following list for possible causes for the burner failure.

1. Ignition failure: Turn control switch to RUN—no spark visible through the peep hole glass, or spark is of low intensity. If an ignition fuse is blown or if the current flow is broken for any other reason, the ammeter in the ignition circuit registers zero when the ammeter test button is pressed in. If the ammeter registers below normal, the spark plug electrodes are dirty or too far apart. If the ammeter registers above normal the electrodes are too close together, or the ignition circuit is grounded.

Check the ignition fuses—use the test lamp and clips installed in the control cabinet for that purpose. Tighten loose cable connections and replace chafed or broken wire which may be breaking or grounding the circuit.

2. Low atomizing air pressure-201: The air switch-101 opens and breaks the circuit to the fuel solenoid valve-104, which then stops the flow of fuel to the sprayhead-105.

Be sure the air admission valve is fully open. Clean the strainer screen in the atomizing air line and drain the atomizing air pressure regulator-100. If the low atomizing air pressure persists, tighten the adjusting screw at the top of the air pressure regulator to increase the atomizing pressure.

3. Low fuel manifold pressure-208: Turn the handle on the suction line fuel filter-206 several times. A slight suction leak may cause the manifold pressure to build up slowly; put the control switch-102 on FILL to bleed the fuel line and bring the manifold pressure up to normal.
4. Low fuel nozzle pressure-207: Lack of water causes the servo fuel control-108 to limit the supply of fuel entering the nozzle.

(If the water supply is almost completely stopped, the cam plate may come down far enough to actuate the cutout switch on the servo and close the fuel solenoid valve-104.)

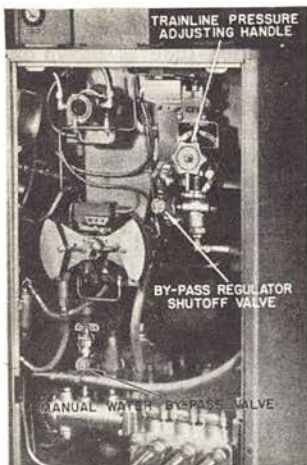

Be sure that the pump, belts have proper tension, the water pump test valve-18 is closed, the cover on the water treatment or strainer tank-234 is tight, the three-way washout valve-17 is fully open, and that the drain valves-20 and 22 are tightly closed.

Feed Water Controls
OK-4630
Fig. 6-7

Open and close the water by-pass regulator-

111 adjusting handle several times to free the regulator from possible sediment. If the water pressure gauge-229 still registers low, close the water by-pass regulator shutoff valve-19. This closes the water by-pass line and permits all of the feed water to flow to the servo-fuel control-108; the steam generator will start at once if the by-pass regulator is causing the trouble. Set and manually regulate the trainline steam pressure by adjusting the manual water by-pass valve-8.

High feed water temperature or leaky water line connections may cause the water pump-230 to become air or vapor bound. Violent fluctuation of the water pressure gauge needle indicates this condition. Tighten leaky water line connections and bleed the line by opening the water pump test valve-18. Allow water to flow from this valve until no air or vapor bubbles are evident in the water.

Irregular Trainline Pressure

1. Burner cycles off and on: Insufficient water delivery causes the steam generator to run in superheat; the steam temperature limit control-110 operates to protect the coils against overheating. Check the water pump output as instructed in the preceding paragraphs.
2. Safety valves blow: Shut down the steam generator. Lower the trainline pressure setting on the adjusting handle of the water by-pass regulator-111 and start the steam generator again. If the safety valves-107 continue to pop, close the water by-pass regulator shutoff valve-19 and manually regulate the trainline steam pressure by opening and adjusting the manual water by-pass valve-8.

REMOTE CONTROL EQUIPMENT

The remote control panel is located on the fireman's side of the locomotive cab. Mounted on it are a master switch to make the panel operative, and push-button switches to operate the separator blowdown valve-12 and the remote control trainline shutoff valve-7. Three warning lights are mounted on the panel and connected to the alarm circuit of the locomotive. The lights are marked "boiler off," "hot engine" and "low oil." A trainline steam pressure gauge is mounted on the panel.

A soot blower switch is also provided. It is to be used only when a steam generator of the CFK type is included in the installation.

The remote control trainline shutoff valve-7 can be closed from the cab; it must be opened manually, however. Depress the reset lever-7a on the trainline shutoff valve-7 to the position marked "open."

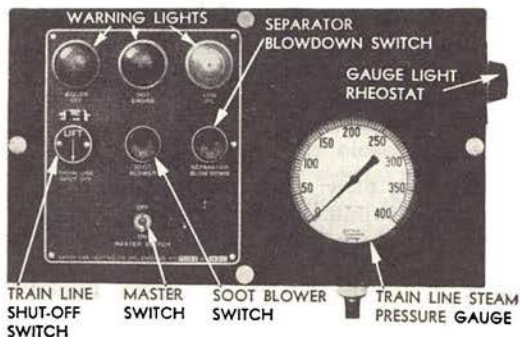

Remote Control Panel
Fig. 6-8

ITEMS TO REPORT

1. Water pressure greater than 450 pounds at any time.
2. Excessive stack temperature.
3. Fluctuation of the fuel manifold pressure.
4. Frequent cycling of the burner.
5. Water flow indicator not cycling.
6. Water by-pass regulator inoperative.
7. Faulty operation of the steam generator for any reason.

STEAM GENERATOR OPERATION CHART
TYPES OK-4630, OK-4625, OK-4616

- 100. Atomizing Air Pressure Regulator
- 101. Atomizing Air Switch
- 102. Control Switch
- 103. Fuel Pressure Regulator
- 104. Fuel Solenoid Valve
- 105. Fuel Spray Head
- 106. Overload Reset Button, Motor
- 107. Safety Valves
- 108. Servo-Fuel Control and Switch
- 109. Stack Switch
- 110. Steam Temperature Limit Control
- 111. Water By-Pass Regulator and Switch
- 112. Water Pressure Relief Valve

- 200. Atomizing Air Strainer
- 201. Atomizing Air Pressure Gauge
- 202. Blower

- 203. Damper
- 204. Fuel Filter (Fuel pressure line)
- 205. Fuel Filter (Servo actuating line)
- 206. Fuel Filter (Suction line)
- 207. Fuel Nozzle Pressure Gauge
- 208. Fuel Pressure Gauge (At fuel pressure regulator)
- 209. Fuel Pump
- 210. Fuel Strainer
- 211. Fuel Tank
- 212. Generator Steam Pressure Gauge
- 213. Heat Exchanger
- 214. Ignition Transformer
- 215. Motor Converter
- 216. Oil Filler Cap
- 217. Radiation
- 218. Return Water Flow Indicator
- 219. Return Water Strainer

- 220. Spark Plugs
- 221. Steam Separator
- 222. Steam Trap (Radiation)
- 223. Steam Trap (Return water line)
- 224. Trainline Steam Pressure Gauge
- 225. Treatment Injector Filter
- 226. Treatment Injector Gauge
- 227. Washout Solution Inlet
- 228. Washout Solution Outlet
- 229. Water Pressure Gauge
- 230. Water Pump
- 231. Water Strainer Manifold
- 232. Water Tank
- 233. Water Treatment Injector Pump
- 234. Water Treatment Tank (Strainer tank only if injector system is used)

VALVES

Valves designated by odd numbers must be **OPEN** during normal operation of the steam generator. Valves designated by even numbers must be **CLOSED** during normal operation of the steam generator. Normally open valves are fitted with a cross type handle, normally closed valves are fitted with the standard round handle. These designations apply only to the OK series steam generators.

The following valves must be **CLOSED** during normal operation of the steam generator:

- 2. Coil Blowdown Valve and Switch
- 4. Fill-Test Valve
- 6. Layover Connection Shutoff Valve
- 8. Manual Water By-Pass Valve
- 10. Steam Admission Valve to Radiation (Open in cold weather)
- 12. Steam Separator Blowdown Valve
- 14. Washout Inlet Valve
- 16. Washout Inlet Valve
- 18. Water Pump Test Valve
- 20. Water Suction Line Drain Valve
- 22. Water Treatment Tank Drain Valve

The following valves must be **OPEN** during normal operation of the steam generator:

- 1. Atomizing Air Shutoff Valve
- 3. Coil Shutoff Valve
- 7. Remove Control Trainline Shutoff Valve
- 7a. Reset Lever
- 9. Return Water Outlet Valve
- 11. Steam Admission Valve to Trainline Pressure Gauge
- 13. Steam Admission Valve to Water By-Pass Regulator
- 15. Stop and Check Valve
- 17. Three-Way Washout Valve
- 19. Water By-Pass Regulator Shutoff Valve
- 21. Water Supply Stop Valve

STEAM GENERATOR TROUBLE SHOOTING CHART

Symptoms	Cause of Trouble	Remedy
Panel lights do not light; bell does not ring (Control switch "OFF" Main boiler switch "ON)	Main battery switch "OPEN"	Close
	Auxiliary generator switch "OPEN"	
	100 amp. boiler fuse (2) blown (distribution panel)	Test and replace
	10 amp. control fuse (2) blown (boiler panel)	Test and replace
Motor does not run (control switch "FILL," bell rings)	Stack switch tripped	Re-set
	Motor overload tripped	Re-set
	Coil blowdown valve "OPEN"	Close
Motor runs, no strong flow of water from water pump test valve	Water tank empty	Fill
	Valve on suction line closed (on line to treatment tank)	Open
	Drain valve on suction line or treatment tank open	Close
	Top of treatment tank not tight	Re-set and tighter
	Treatment tank strainer clogged	Clean
	Water in storage tank too hot	Make sure steam heat valve to water tank is closed

STEAM GENERATOR TROUBLE SHOOTING CHART (CONT'D)

Symptoms	Cause of Trouble	Remedy
Motor runs, no spark at electrodes	Wires from electrodes to transformer broken or grounding	Repair
	Terminals loose on transformer	Tighten
	Gap between electrodes too wide	Reduce gap (should be 3/16")
	10 amp. ignition fuse (2 on boiler panel) blown	Test and replace
Motor runs, fire does not light "Run"	Atomizing air valve closed	Open
	Motor not allowed to stop before turning switch to run	Turn "fill" briefly, then to "off." After <u>motor has stopped</u> and servo control is all the way down, turn to "Run"
	Electrodes not properly adjusted	Adjust. Report to maintenance.
	Nozzle not properly adjusted	Adjust. Report to maintenance.
Generator shuts off, bell rings	Stack switch tripped	Reset stack switch, refill coils, start steam generator, and set water by-pass regulator at slightly lower pressure. Report to maintenance.

STEAM GENERATOR TROUBLE SHOOTING CHART (CONT'D)

Symptoms	Cause of Trouble	Remedy
Generator shuts off,	Motor overload relay trips, shutting down generator	Reset overload relay, refill coils and start steam generator. Report to maintenance.
Generator runs, dome gets hot	Lack of air, dirty coils	Set water by-pass regulator back 10 to 15 lbs. Report to maintenance.
Generator runs but no water returns through water flow indicator	Valve in return line from separator closed	Open
	Return water strainer clogged	Clean
	Steam too dry	Report to maintenance
Generator runs but trainline pressure cannot be controlled by water by-pass regulator	Steam admission valve closed	Open
	Water admission valve closed	Open
	Defective water by-pass regulator	Close water shutoff valve to water by-pass regulator, use manual by-pass valve to control pressure. Report to maintenance.



SECTION 6-A

STEAM GENERATOR ELESKO TYPE

INTRODUCTION

The instructions contained in this section are for the guidance of personnel engaged in the operation of Elesco steam generators. A general description of the steam generator is given, the operating technique is outlined and a trouble shooting section is provided for the operator.

The numbers in parentheses are identified in the numerical listing at the end of the section. Some of these items are illustrated in this section, however some of the reference numbers not illustrated will be found on the schematic chart mounted on the locomotive close to the steam generator.

DESCRIPTION

The Elesco steam generators have a rated capacity of 2300 and 3000 lbs. of water evaporation per hour. Operation is completely automatic after the steam generator is started, and full operating steam pressure is reached within a few minutes. The steam generator operates on the forced recirculation principle and, therefore, is not dependent upon natural circulation. A small hot water circulating pump, close-coupled to an electric motor, forces the hot water which is contained in the system at steam temperature through the elements of the generator. While the generator is in operation, the quantity of water circulated is constant, regardless of steam output. At maximum capacity, the quantity of water circulated is approximately ten times

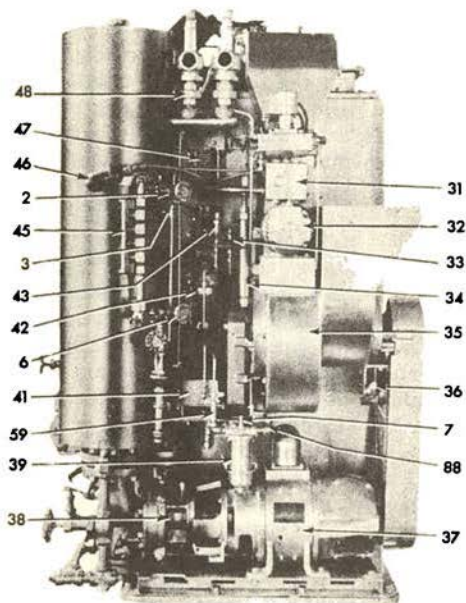
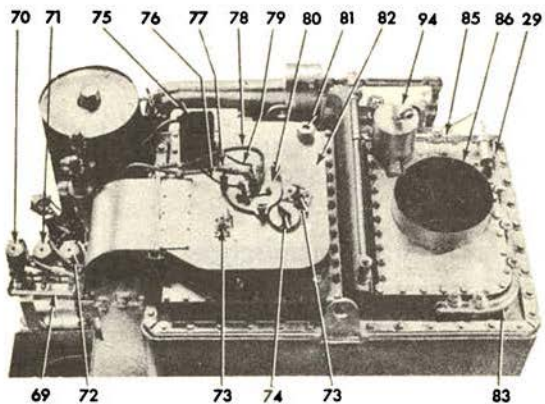

Fig. 6-1 - Steam Generator — Top And Side Views

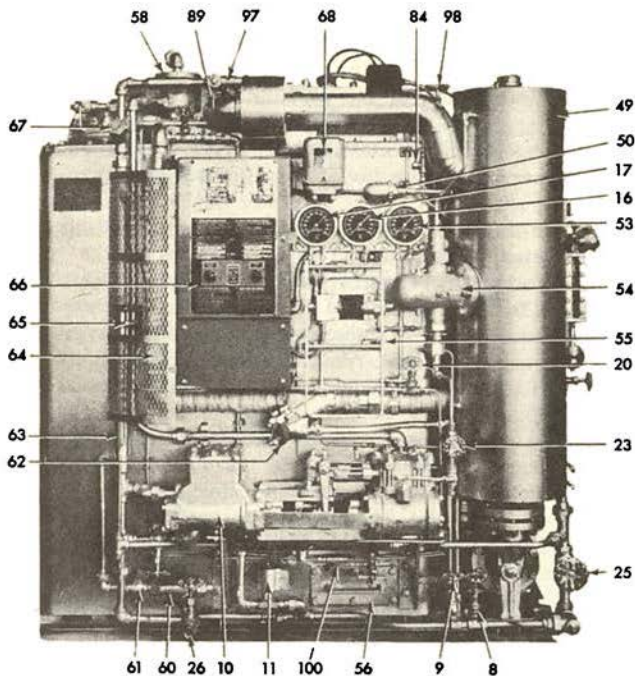

Fig. 6-2 - Steam Generator — Front View

the amount of steam produced. The forced recirculation principle assures efficient heat transfer and eliminates scale formation almost entirely.

The steam generator consists of a radiant or combustion chamber section and a convection section. The heating surface of the radiant section consists of three elements forming the envelope of the combustion chamber. Each element is connected to the inlet and

outlet headers. The convection section consists of five elements, each of which is also connected to the inlet and outlet headers. Each of the eight elements is equipped with an orifice at the inlet end to insure proper distribution of the circulated water.

The electric motor which drives the circulating pump also drives the fuel oil pump and blower.

The feedwater pump is of the reciprocating type and is steam-operated. The steam flow to the pump is controlled by the feedwater regulator, which is actuated by a float located in the steam separator. A rise in water level reduces the feedwater regulator valve opening and retards the speed of the pump, and a reduction in water level effects the reverse.

The burner is designed to utilize light grades of fuel oil such as Diesel oil. The burner head has three mechanical atomizing burner nozzles one of which is referred to as the "small burner" and the other two combined as the "large burner." Electric ignition is employed and the spark is only provided during a five second ignition period. Only the small burner is ignited when lighting up after which the larger burner is later ignited by the flame of small burner.

The fuel oil supply to small burner atomizing nozzle is not regulated. The fuel oil pumped to the larger burner mechanical atomizing nozzles is controlled by an oil regulating valve actuated by steam pressure. When the steam pressure is low, fuel oil flow to the larger burner will be maximum, and an increase in steam pressure above normal will result in a reduction of fuel oil flow. Proper mixture of air and fuel oil is automatically maintained at all rates of firing, thus high combustion efficiency is assured at all load settings.

THE CONTROL FOR THE WATER AND THE CONTROL FOR THE FUEL OIL ACT INDEPENDENTLY OF EACH OTHER AND THUS DO NOT HAVE TO BE COORDINATED.

The steam supply to the trainline is controlled by a reducing valve which can be adjusted to give the desired trainline pressure. A manual by-pass valve is incorporated in the reducing valve body, the handle of which is located on the opposite end of the reducing valve. This by-pass valve can be used to feed the trainline in case proper regulation cannot be obtained with the reducing valve. A trainline shut-off solenoid valve and an under-pressure valve are located in the reducing valve pressure control line to open or close the reducing valve. The trainline shut-off solenoid valve must be manually latched open to permit the reducing valve to open. It can be tripped by remote control from the cab, thereby closing the reducing valve and shutting off the steam supply to the trainline.



Fig. 6-3 - Remote Control Panel

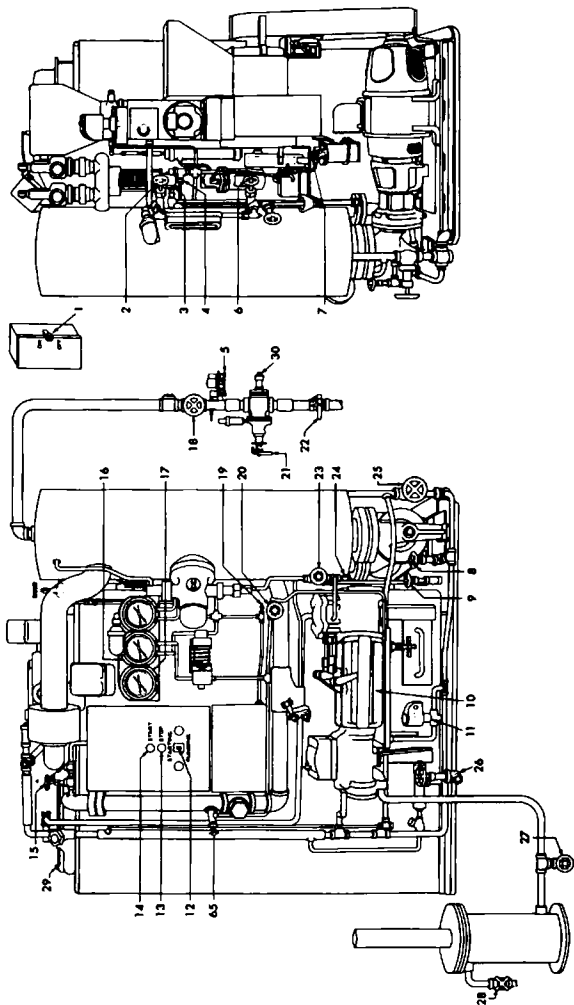

Fig. 6-4 - Elesco Steam Generator

Before Starting Steam Generator

1. Auxiliary generator on locomotive should be running and main air reservoir should have at least 60 lbs. pressure.
2. Check position of all valves. Valves with cross handles should be fully opened. Valves with round handles should be closed, excepting water glass valves (2 and 6).
3. Turn handles (7) on fuel oil strainer one full turn.
4. Close main switch by moving handle (1) to the "ON" position.

Starting Steam Generator

1. If no water shows in the glass, run feedwater pump (10) on air as follows:
 - a. Close pump steam valve (23).
 - b. Open pump air valve (9).
 - c. Open steam separator air vent cock (3), while filling.
2. When water reaches top of water glass, place control switch (12), in starting position. Push "START" button (14), and motor will run.
3. Continue to operate feedwater pump on air until water remains in water glass, then shut pump air valve (9) and open pump steam valve (23).
4. Close steam separator air vent cock (3).
5. Push and release differential pressure valve water line snubber (65) two or three times to insure full opening in pressure line to differential pressure valve.
6. Place control switch (12), in running position. Steam generator will fire.
7. As steam generator comes up to pressure, water will tend to rise, use manual blow-down valve (25) to keep about 1/2 glass of water.

To Feed Steam To Train Line

Steam generator pressure should be 275 lbs. shown on pressure gauge (16) red hand before proceeding.

1. Set lever of steam flow control valve (22) in position 2.
2. Open remote control steam shut-off solenoid valve (5) by pulling lever down to latched position.
3. Slowly open main steam line shut-off valve (18) to full open position.
4. If required, use manual blow-down valve (25) to keep about 1/2 glass of water.
5. Loosen wing lock nut on stem of steam pressure reducing valve (21), and adjust this valve to give the desired reducing valve setting. After reducing valve to set, tighten wing lock nut.
6. For high trainline steam demands, during cold weather, move lever of steam flow control valve (22) very slowly to position 4.
7. When trainline is fully charged, trainline pressure will be about reducing valve pressure. These pressures show on steam gauge (17).

Paralleling Steam Generators

1. Set steam flow control valve levers (22) in same position.
2. Adjust reducing valve (21) to have about same pressures, white hand on steam pressure gauge (17) within 5 to 10 lbs.

Running Attention

1. Operate remote control solenoid blow-down valve (11) about 5 seconds every 1/2 hour by means of separator blow-down switch on remote control panel in locomotive cab.

To Shut Down Steam Generator

1. Close steam shut-off valve (18), and open manual blow-down valve (25), slowly and blow for 5 seconds.
2. Push "STOP" button (13), the motor will continue to run but at a reduced speed for cool-down period.
3. When steam pressure has dropped to about 50 lbs. motor will automatically stop. After motor has stopped, move main switch handle (1) to "OFF" position.

To Shut Down Steam Generator Enroute During Cold Weather

1. Close steam line shut-off valve (18).
2. Push "STOP" button (13).
3. Open manual blow-down valve (25) and circulating pump drain valve (8) wide to thoroughly blow-down generator. After generator is blown down leave these valves cracked open.
4. Open oil regulating valve drain (4), differential pressure valve steam line drain (19), differential pressure valve water line drain (20), and feedwater pump steam line drain (24). Close water suction line stop valve (28) and open feed pump suction line drain valve (27).
5. Open steam generator heater valve (15). This connects steam generator to trainline, allowing steam from trainline to enter to prevent freezing.
6. Move main switch handle (1) to "OFF" position.

TROUBLE SHOOTING

NORMAL	TROUBLE	ACTION
1. When main switch closed		
a. Pressure gauge lamp, water glass lamp, and electric eye indicating lamp all light.	If one of these lamps does not light.	Check for burned out lamp.
	If none of these lamps light.	Check for blown main line fuses or tripped line circuit breaker if used. Check for blown fuses in motor control cabinet.
b. Alarm bell should not ring.	If alarm bell rings.	Push "Stop" button in. Check control switch - it should be in "Starting" position.
2. After pushing "Start" button with control switch in "Starting" position.		
a. "Stop" button is automatically released.	If "Stop" button does not release.	Check "Start" and "Stop" buttons for defects.

TROUBLE SHOOTING

NORMAL	TROUBLE	ACTION
<p>(2. Continued)</p> <p>b. Motor starts and comes up to speed, driving circulating pump, fuel oil pump, and blower.</p>	<p>If motor does not start.</p>	<p>Check "Reset" of motor overload relay in motor control cabinet. Reset if necessary by pushing reset button down. Check main line fuses (or if circuit breaker is used, reset it if found tripped.) Check for blown fuses in motor cabinet.</p>
<p>c. "Start" indicating lamp lights.</p>	<p>If "Start" indicating lamp does not light and motor is running.</p>	<p>Check for burned out lamp.</p>
<p>d. Alarm bell should not ring.</p>	<p>If alarm bell rings.</p>	<p>Check control switch. It should be in "Starting" position.</p>

ELECTRO-MOTIVE DIVISION • GENERAL MOTORS CORPORATION
 FT-6A-1149
 STEAM GENERATOR

TROUBLE SHOOTING

NORMAL	TROUBLE	ACTION
<p>3. Steam Generator Running.</p> <p>a. Pressure gauge, white hand, circulating pump pressure should be 30 to 40 lbs. greater than red hand. (The 30 to 40 lbs. difference in these pressures is called "Differential Pressure.") It shows steam generator has proper water circulation.</p>	<p>If there is no differential pressure or pressure is low or unsteady.</p>	<p>Check for proper amount of water in steam generator about 1/2 glass and add water if necessary. Push plunger on snubber in differential pressure valve water line to clean snubber. Check circulating pump discharge line strainer — it may require cleaning.</p>
<p>b. Fuel oil pressure gauge, red hand, pump pressure should be 250 lbs.</p>	<p>If fuel oil pump pressure is low or no pressure.</p>	<p>Check for oil in pump suction line by inspecting flow in sight glass. Turn handle on fuel oil pump suction line</p>

TROUBLE SHOOTING

NORMAL	TROUBLE	ACTION
(3. Continued)		strainer to clean strainer. Pressure gauge may be defective. Check to see that fuel oil pump shaft is rotating. Check belt tension. Fuel oil relief valve may be stuck open.
	If fuel oil pump pressure is too high.	Fuel oil relief valve may be stuck closed. Fuel return line may be plugged. Pressure gauge may be defective.
c. Main oil solenoid valve opens after differential pressure is established. It makes a definite "click" when it opens.	If main oil solenoid valve does not open.	Check for defective valve.

TROUBLE SHOOTING

NORMAL	TROUBLE	ACTION
<p>4. Control switch is placed in "Running" position to make steam generator fire.</p>		
<p>a. "Burner On" lamp lights.</p>	<p>If "Burner On" lamp does not light and steam generator fires.</p>	<p>Check for burned out lamp.</p>
	<p>If "Burner On" lamp does not light and alarm bell rings.</p>	<p>Check Items under "Action" 3-a.</p>
<p>b. Small burner oil solenoid valve opens. This will be indicated by fuel oil pressure gauge, red hand dropping slightly. Ignition converter</p>	<p>If steam generator does not fire within about 5 seconds, shut-down will occur and alarm bell will ring.</p>	<p>Restart steam generator, check fuel oil pump pressure and when control switch is placed in "Running" position note slight drop in fuel oil pump pressure which indicates that small burner oil</p>

TROUBLE SHOOTING

NORMAL	TROUBLE	ACTION
<p>(4. Continued)</p> <p>runs for about 5 seconds providing spark, after which it cuts out. As soon as fire is established electric eye indicating lamp goes out.</p>	<p>If no spark or improper spark.</p>	<p>solenoid valve opens. If no drop in pressure, check for defective small burner oil solenoid valve or main oil solenoid valve. Check small burner nozzle for plugging. Check through burner peep hole for proper spark. Check air damper and rigging to see that it is in low position.</p> <p>Check electric wiring between ignition transformer and electrodes. Check for dirty or defective electrodes. (Gap between electrodes should be 3/16".) Check to see if ignition converter is running.</p>

TROUBLE SHOOTING

NORMAL	TROUBLE	ACTION
<p>(4. Continued)</p>	<p>If steam generator fires for about 5 seconds and electric eye indicating light remains on and then a shut-down occurs with both "Start" and "Burner On" indicating lights going out and alarm bell rings.</p>	<p>With steam generator shut down, clean electric eye shutter sight glasses. Check electric eye tubes.</p>
<p>c. Steam generator operates on small burner until steam pressure, red hand on pressure gauge, is about 30 lbs. The large burner solenoid valve then opens and large burner comes on, this is indicated by</p>		

TROUBLE SHOOTING

NORMAL	TROUBLE	ACTION
<p>(4. Continued)</p> <p>pressure showing on white hand of fuel oil gauge. Oil pressure of large burner starts to fall off when steam pressure reaches 260 lbs. and oil pressure drops to zero when steam pressure reaches 270 lbs. When steam pressure reaches 290 lbs. small burner automatically shuts down and then "Burner On" indicating light goes out.</p>	<p>If large burner oil pressure, white hand of fuel oil gauge, does not start to decrease at about 260 lbs. steam pressure and large burner remains on until "Burner On" indicating lamp goes out.</p>	<p>Check for defective oil regulating valve bellows. This is indicated by steam leak at lower part of assembly.</p>

TROUBLE SHOOTING

NORMAL	TROUBLE	ACTION
<p>5. Steam generator operating with trainline shut-off valve closed.</p> <p>a. Steam generator fire is automatically cut out when steam pressure reaches 290 lbs. When steam pressure drops to 275 lbs. it refires. Small burner going on and off at short intervals is called "Cycling."</p>	<p>If steam generator shuts down when cycling; alarm bell rings with both the "Start" and "Burner On" indicating lights out; and motor running at reduced speed.</p> <p>If alarm bell rings with "Start" indicating light on and "Burner On" indicating light out.</p>	<p>Place control switch in "Starting" position — this will cut out alarm bell. Restart steam generator. Place control switch in "Running" position. Also check items under "Action" 4-b.</p> <p>Check items under "Action" 3-a. Check feedwater pump steam valve for full open. Check water glass on steam separator for indication that water in steam separator may be foaming — if so, give good blow-down using manual blow-down valve.</p>

TROUBLE SHOOTING

NORMAL	TROUBLE	ACTION
(5. Continued)	If smoke shows at stack when refiring and then stack clears.	Check small burner air damper and electrodes. Burner is not igniting as quickly as it should.
<p>6. Steam generator feeding steam to trainline.</p> <p>a. With low steam demand steam generator may cycle as in "5." With normal steam demand, both the small and large burners will be on. Large burner pressure, white hand on fuel oil gauge, is controlled by oil regulating valve and it varies with steam demand.</p>	If steam generator stops firing; alarm bell rings with "Start" indicating light on; and "Burner On" indicating light out.	Check differential pressure, water in glass, water storage tank, feedwater pump and its piping. Check feedwater pump steam valve for full open. Check action feedwater pump; may be sucking air through leaky cover on water treatment tank. Check items under "Action" 5-a. Check treatment tank drain valve. Should be closed.

F7-6A-1149

ELECTRO-MOTIVE DIVISION



GENERAL MOTORS CORPORATION

STEAM GENERATOR

TROUBLE SHOOTING

NORMAL	TROUBLE	ACTION
(6. Continued)	If steam generator shuts down; alarm bell rings; "Start" and "Burner On" indicating lights out; and motor running at reduced speed.	Check for fuel oil pump pressure. With steam generator off, clean electric eye shutter sight glasses. Also check items "Action" 4-b.
	If steam generator shuts down, alarm bell rings, both indicating lights out, motor shuts down.	Check for blown main line fuses. Also check items under "Action" 2-b.
	If smoke shows at stack with large burner on.	Check action of air damper and rigging. Check blower belt drive.

Ref. No.	Name Of Part	Refer to Figures
1.	Main Switch.	6-5
2.	Water Glass Upper Shut-off Valve	6-1, 6-5
3.	Steam Separator Air Vent Cock.	6-1, 6-5
4.	Fuel Oil Regulating Valve Drain Cock . .	6-5
5.	Remote Control Steam Line Shut-off Solenoid Valve	6-5
6.	Water Glass Lower Shut-off Valve	6-1, 6-5
7.	Fuel Oil Pump Suction Line Strainer Handle.	6-1, 6-5
8.	Circulating Pump Drain Valve	6-2, 6-5
9.	Feedwater Pump Air Valve	6-2, 6-5
10.	Feedwater Pump	6-2, 6-5
11.	Remote Control Blow-Down Solenoid Valve	6-2, 6-5
12.	Control Switch	6-5
13.	"Stop" Button	6-5
14.	"Start" Button	6-5
15.	Steam Generator Heater Valve	6-5
16.	Steam Generator Pressure Gauge.	6-2, 6-5
17.	Steam Line Pressure Gauge.	6-2, 6-5
18.	Steam Line Shut-off Valve.	6-5
19.	Differential Pressure Valve Steam Line Drain	6-5
20.	Differential Pressure Valve Water Line Drain	6-2, 6-5
21.	Steam Pressure Reducing Valve	6-5
22.	Steam Flow Control Valve.	6-5
23.	Feedwater Pump Steam Valve.	6-2, 6-5
24.	Feedwater Pump Steam Line Drain	6-5
25.	Manual Blow-Down Valve	6-2, 6-5
26.	Washout Valve	6-2, 6-5
27.	Feedwater Pump Suction Line Drain Valve	6-5
28.	Feedwater Pump Suction Line Valve	6-5
29.	Inlet Header Pipe Plug	6-5
30.	Manual By-Pass	6-5
31.	Oil Burner Control Junction Box	6-1

Ref. No.	Name Of Part	Refer to Figures
32.	Ignition Converter.	6-1
33.	Air Damper Control Cylinder Drain Sight Glass	6-1
34.	Air Damper Control Cylinder	6-1
35.	Blower	6-1
36.	Blower Belt Idler	6-1
37.	Operating Motor	6-1
38.	Circulating Pump	6-1
39.	Fuel Oil Pump Suction Line Strainer	6-1
41.	Fuel Oil Pump	6-1
42.	Fuel Oil Pressure Filter	6-1
43.	Fuel Oil Relief Valve	6-1
44.	Orifices	*
45.	Water Glass	6-1
46.	Water Glass Light	6-1
47.	Fuel Oil Regulating Valve	6-1
48.	Safety Valves	6-1
49.	Steam Separator.	6-2
50.	Pressure Gauge Light	6-2
51.	Radiant Elements	*
52.	Convection Elements	*
53.	Fuel Oil Pressure Gauge	6-2
54.	Feedwater Regulator	6-2
55.	Differential Pressure Valve and Switch Assembly	6-2
56.	Access Door.	6-2
58.	Water Separator.	6-2
59.	Fuel Oil Suction Line Sight Glass	6-1
60.	Automatic Blow-Down Valve	6-2
61.	Automatic Blow-Down Line Spring Loaded Check	6-2
62.	Circulating Pump Discharge Line Strainer.	6-2
63.	Automatic Blow-Down Heat Exchanger	6-2

* Not Illustrated

Ref. No.	Name Of Part	Refer to Figures
64.	Circulating Pump Discharge Line Check Valve	6-2
65.	Differential Pressure Valve Water Line Snubber	6-2, 6-5
66.	Steam Generator Control Cabinet	6-2
67.	Feedwater Pump Discharge Line Check Valve	6-2
68.	Electric Eye Flame Failure Control	6-2
69.	Fuel Oil Solenoid Valve Manifold	6-1
70.	Main Oil Solenoid Valve	6-1
71.	Large Burner Oil Solenoid Valve	6-1
72.	Small Burner Oil Solenoid Valve	6-1
73.	Soot Remover Air Gates	6-1
74.	Cover for Soot Remover Container	6-1
75.	Ignition Transformer	6-1
76.	Ignition Electrodes Lead Wires	6-1
77.	Small Burner Flexible Oil Hose	6-1
78.	Large Burner Flexible Oil Hose	6-1
79.	Ignition Electrodes	6-1
80.	Burner Head	6-1
81.	Oil Burner Peep Hole	6-1
82.	Burner Wind Box	6-1
83.	Inlet Header	6-1
84.	Differential Pressure Valve Steam Line Snubber	6-2
85.	Feedwater Heater	6-1
86.	Smoke Stack Opening	6-1
88.	Fuel Oil Suction Line Check Valve	6-1
89.	Outlet Header	6-2
90.	Sludge Settling Chamber	*
91.	Water and Steam Inlet to Steam Separator	*
92.	Water Separator Primary Chamber	*
93.	Steam Separator Secondary Chamber	*

* Not Illustrated

STEAM GENERATORF7-6A-1149

Ref. No.	Name Of Part	Refer to Figures
94.	Feedwater Pump Exhaust Vent Pipe	6-1
95.	Sludge Settling Chamber Inlet.	*
96.	Sludge Settling Chamber Outlet.	*
97.	Sludge Settling Chamber Metering Choke	6-2
98.	Pressure Gauge Steam Line Shut-off Valve.	6-2
99.	Feedwater Pump Steam Heat Exchanger. .	*
100.	Circulating Pump Stuffing Box Cooling Water Strainer	6-2

* Not Illustrated

