

KF13860

NEDL TRANSFER

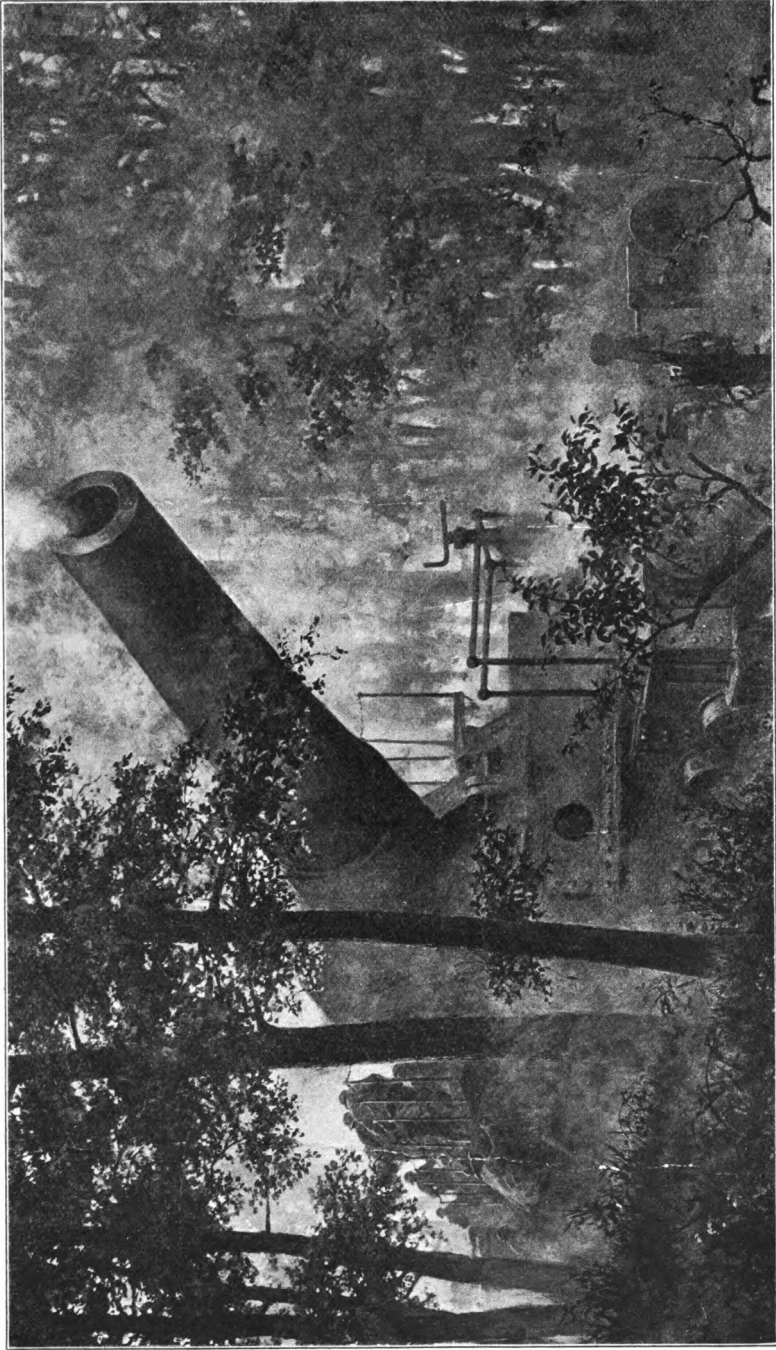

HN 61B2 Y



Frontispiece. THE ALLIES REPLY TO THE GERMAN 420. 400-MM. ST. CHAMOND RAILWAY MOUNT.

SECRET

U.S. Ordnance Department, Document No. 2034

RAILWAY ARTILLERY

A REPORT ON
THE CHARACTERISTICS,
SCOPE OF UTILITY, ETC.
OF
RAILWAY ARTILLERY

IN TWO VOLUMES

VOLUME II



WASHINGTON
GOVERNMENT PRINTING OFFICE
1922

KF 13860



WAR DEPARTMENT,
OFFICE OF THE CHIEF OF ORDNANCE,
June 15, 1922.

This work on Railway Artillery is a Report on the Characteristics, Scope of Utility, etc., of Railway Artillery, prepared by H. W. Miller, lieutenant colonel of Ordnance Reserve Corps. This report is approved for publication for confidential use only.

C. C. WILLIAMS,
Major General, United States Army,
Chief of Ordnance.

(11)

PREFACE.

To repeat a portion of the preface of Volume I, this volume is a part of a report submitted by the Heavy Artillery Section, Engineering Division, Office of the Chief Ordnance Officer, A. E. F., France. The original report was submitted in April, 1918, and was so framed as to answer, as well as time for the investigation permitted, questions that were troubling the designers and builders of this type of artillery in America.

The second and more complete report was completed in March, 1919. In this report an attempt was made to record as many as possible of the lessons learned during the war and to give working descriptions of all of the artillery of this type owned or used by our allies, the Entente, and by ourselves.

When it was decided to publish the report to serve both as a reference and text our allies were consulted with reference to the publishing of the descriptions of their artillery. Each replied that they had no objection to its being published and used confidentially, but they preferred not to have it published for general and public distribution. This second volume is hence issued for confidential use only.



The following is a summary of the report...
 The report was prepared by...
 The purpose of the report is to...
 The findings of the report are...
 The conclusions of the report are...
 The recommendations of the report are...

CONTENTS.

(This elaborate table of contents is given in lieu of an index. Since the entire volume is devoted to the detailed description of the various mechanisms of a definite group of guns and mounts it is believed that such a table will more effectively serve the purposes of users of the book than an index of the conventional type. In the text reference is sometimes made to matériel by number. These numbers are those given in left column of table below.)

FRENCH ARTILLERY.

1. 120-millimeter gun on Schneider-Canet-Peigne railway mount.....	1-5
History	1-2
Recoil mechanism.....	3
Traversing mechanism.....	4
Trucks	5
2. 155-millimeter howitzer on Schneider-Canet-Peigne railway mount...	6-8
History	6
Railway car body.....	7
System of anchorage.....	8
3. 155-millimeter gun on improvised mount.....	9-10
General description.....	9
System of anchorage.....	10
4. 164.7-millimeter gun on improvised mount.....	11-13
History and general description.....	11-12
System of anchorage.....	13
5. 194.4-millimeter howitzer, model 1875-76 on improvised mount.....	14-23
General description.....	15
Recoil mechanism.....	25
Elevating mechanism.....	16-17
Traversing mechanism.....	18
Gun carriage.....	19
Railway car body.....	20
System of anchorage.....	21
Trucks	22
Ammunition supply system.....	23
6. 194.4-millimeter howitzer, model 1875-76, on carriage, model 1917....	24-31
General description.....	24
Recoil mechanism.....	25
Elevating mechanism.....	26
Traversing mechanism.....	27
Gun carriage.....	28
Railway car body.....	29
System of anchorage.....	30
Difficulties involved in service.....	31
7. 194.4-millimeter howitzer, model 1875, 1876, 1878, on three axle mount..	32
8. 194.4-millimeter gun, model 1887, 1893, 1896, 1902, on improvised mount	33
9. 194.4-millimeter gun, model 1870, 1893 on improvised mount.....	34

10. 194.4-millimeter gun, model 1870, 1893 on three axle mount.....	35
11. 194.4-millimeter gun, model 1870, 1893 on double truck mount.....	36-44
General description.....	36
Recoil mechanism.....	37
Elevating mechanism.....	38
Traversing mechanism.....	39
Gun carriage.....	40
Railway car body.....	41
System of anchorage.....	42
Ammunition supply system.....	43
Difficulties involved in service.....	44
12. 200-millimeter howitzer on special mount.....	45-54
History.....	45
Gun.....	46
Recoil mechanism.....	47
Elevating mechanism.....	48
Traversing mechanism.....	49
Gun carriage.....	50
System of anchorage.....	51
Trucks.....	52
Ammunition supply system.....	53
Merits.....	54
13. 240-millimeter howitzer, Model 1876, on improvised mount.....	55
14. 240-millimeter howitzer, Model 1876, on railway mount, Model 1917.....	56
15. 240-millimeter howitzer, Model 1876, on G. P. C. mount.....	57-64
History.....	57
Recoil mechanism.....	58
Elevating mechanism.....	59
Traversing mechanism.....	60
Gun carriage.....	61
Railway car body.....	62
System of anchorage.....	63
Trucks.....	64
16. 24-millimeter gun, Model 1893, 1896, on St. Chamond mount.....	65-79
General description.....	65
Gun.....	66
Recoil mechanism.....	67
Elevating mechanism.....	68-69
Traversing mechanism.....	70
Gun carriage.....	71
Railway car body.....	72
System of anchorage.....	73-75
Trucks.....	76
Ammunition supply system.....	77
Maintenance.....	78
Difficulties involved in service.....	79
17. 240-millimeter gun, Model 1884, on mount without traverse.....	80
18. 240-millimeter gun, Model 1884, on mount with traverse.....	81
19. 240-millimeter gun, Model 1870, 1884, 1887.....	82-86
General description.....	82
Gun.....	83
Elevating mechanism.....	84
System of anchorage.....	85
Ammunition supply system.....	86

20. 240-millimeter gun, Model 1903.....	87-97
General description	87
Gun.....	88
Recoil mechanism.....	89
Elevating mechanism.....	90
Traversing mechanism.....	91
Railway car body.....	92
System of anchorage.....	93
Trucks.....	94
Ammunition supply system.....	95
Difficulties in service.....	96
Merits.....	97
21. 274.4-millimeter howitzer, Model 1870, 1881, and 1870M.....	98-106
General description.....	98
Gun.....	99
Recoil mechanism.....	100
Elevating mechanism.....	101
Traversing mechanism.....	102
Railway car body.....	103
System of anchorage.....	104
Trucks.....	105
Ammunition supply system.....	106
22. 274.4-millimeter gun, Model 1893, on improvised mount.....	107-117
General description.....	107
Gun.....	108
Recoil mechanism.....	109
Elevating mechanism.....	110
Traversing mechanism.....	111
Gun carriage.....	112
Railway car body.....	113
System of anchorage.....	114
Trucks.....	115
Ammunition supply system.....	116
Maintenance.....	117
23. 274.4-millimeter gun, Model 1893, 1896, on sliding type mount.....	118-128
General description.....	118
Gun.....	119
Recoil mechanism.....	120
Elevating mechanism.....	121
Traversing mechanism.....	122
Gun carriage and railway car body.....	123
System of anchorage.....	124-125
Trucks.....	126
Ammunition supply system.....	127
Maintenance.....	128
24. 274.4-millimeter gun, Model 1893, 1896, with recoil on mount.....	129-136
General description.....	129
Gun.....	130
Recoil mechanism.....	131
Elevating mechanism.....	132
Traversing mechanism.....	133
Gun carriage and railway car body.....	134
System of anchorage.....	135
Ammunition supply system.....	136

25. 285-millimeter gun, Model 1893, 1896.....	137
26. 293-millimeter mortar, Model 1903.....	138-141
General description.....	138
Gun.....	139
Recoil mechanism.....	140
Ammunition supply system.....	141
27. 305-millimeter gun, Model 1893, 1896, on Batignolles mount.....	142-153
General description and history.....	142
Gun.....	143
Recoil mechanism.....	144
Elevating mechanism.....	145
Traversing mechanism.....	146
Gun carriage.....	147
Railway-car body.....	148
System of anchorage.....	149
Ammunition supply system.....	150
Maintenance.....	151
Difficulties in service.....	152
Merits and demerits.....	153
28. 305 millimeter gun, Model 1893, 1896, on St. Chamond mount.....	154-158
General description.....	154
Elevating mechanism.....	155
Traversing mechanism.....	156
System of anchorage.....	157
Demerits.....	158
29. 305-millimeter gun, Model 1893, 1896, on sliding type mount.....	159
30. 305-millimeter gun, Model 1906, 1910, on sliding type mount.....	160-161
General description.....	160
Trucks.....	161
31. 320-millimeter howitzer, Model 1870, 1884, 1893, on sliding type mount.....	162-164
General description.....	162
Gun.....	163
Elevating mechanism.....	164
32. 320-millimeter howitzer, Model 1870, 1881, on sliding type mount...	165
33. 320-millimeter howitzer, Model 1881, 1884, on sliding type mount....	166-167
General description.....	166
Elevating mechanism.....	167
34. 340-millimeter gun, Model 1893, on sliding type mount.....	168
35. 340-millimeter gun, Model 1912, on St. Chamond mount.....	169-183
General description.....	169
Gun.....	170
Recoil mechanism.....	171
Elevating mechanism.....	172
Traversing mechanism.....	173
Railway-car body.....	174
System of anchorage.....	175-179
Trucks.....	180
Ammunition supply system.....	181
Maintenance.....	182
Difficulties in service.....	183
36. 340-millimeter gun, Model 1912, on sliding type mount.....	184
37. 370-millimeter howitzer on Batignolles mount.....	185
38. 370-millimeter howitzer, Model 1875, 1879, on sliding type mount...	186-187

39. 400-millimeter howitzer, on St. Chamond mount.....	188-199
General description.....	188
Recoil mechanism.....	189
Elevating mechanism.....	190
Traversing mechanism.....	191
Gun carriage.....	192
Railway-car body.....	193
System of anchorage.....	194-196
Trucks.....	197
Ammunition-supply system.....	198
Maintenance.....	199
40. 520-millimeter howitzer, on sliding-type mount.....	200-210
General description and history.....	200-201
Gun.....	202
Recoil mechanism.....	203
Elevating mechanism.....	204
Traversing mechanism.....	205
System of anchorage.....	206
Trucks.....	207
Ammunition-supply system.....	208
Merits.....	209
Demerits.....	210

BRITISH ARTILLERY.

41. 9.2-inch gun, Mark XIII on railway mount.....	211-221
General description.....	211
Gun.....	212
Recoil mechanism.....	213
Elevating mechanism.....	214
Traversing mechanism.....	215
Gun carriage.....	216
Railway-car body.....	217
System of anchorage.....	218
Trucks.....	219
Ammunition-supply system.....	220
Difficulties in service.....	221
42. 9.2-inch guns, Marks X and XIV on railway mount.....	222-223
43. 9.2-inch guns, Marks III to VIc.....	224-232
General description.....	224
Gun.....	225
Recoil mechanism.....	226
Elevating mechanism.....	227
Traversing mechanism.....	228
Gun carriage.....	229
Railway-car body.....	230
System of anchorage.....	231
Ammunition-supply system.....	232
44. 12-inch howitzer, Marks I and II.....	233-241
General description.....	233
Gun.....	234
Recoil mechanism.....	235
Elevating mechanism.....	236
Traversing mechanism.....	237

44. 12-inch howitzer, Marks I and II—Continued.	
Gun carriage	238
Railway-car body	239
System of anchorage	240
Ammunition-supply system	241
45. 12-inch howitzers, Marks III and V.....	242-250
General description	242
Gun.....	243
Recoil mechanism.....	244
Elevating mechanism	245
Traversing mechanism	246
Gun carriage	247
Railway-car body	248
System of anchorage.....	249
Ammunition-supply system	250
46. 12-inch gun, Mark IX.....	251-263
General description	251
Gun.....	252
Recoil mechanism.....	253-255
Elevating mechanism	256
Traversing mechanism	257
Gun carriage	258
Railway car body.....	259
System of anchorage.....	260
Trucks.....	261
Ammunition supply system.....	262-263
47. 12-inch gun.....	264-275
General description	264
Gun	265
Recoil mechanism	266
Elevating mechanism	267
Traversing mechanism	268-270
Gun carriage.....	271
Railway car body.....	272
System of anchorage.....	273
Trucks.....	274
Ammunition supply system.....	275
48. 14-inch gun, Mark III.....	276-290
General description and history.....	276
Gun	277
Recoil mechanism	278-279
Elevating mechanism	280
Traversing mechanism.....	281
Gun carriage.....	282
Railway car body.....	283
System of anchorage.....	284
Trucks.....	285
Ammunition supply system.....	286
Maintenance	287
Difficulties involved in service.....	288
Merits	289
Demerits.....	290

ITALIAN ARTILLERY.

49. 381-millimeter gun, on sliding type mount.....	291-301
General description.....	291
Gun.....	292
Recoil mechanism.....	293
Elevating mechanism.....	294
Traversing mechanism.....	295
Gun carriage.....	296
Railway car body.....	297
System of anchorage.....	298
Trucks.....	299
Ammunition supply system.....	300
Maintenance.....	301

AMERICAN ARTILLERY.

50. 14-inch gun, on railway mount, Model 1920.....	302-323
General description and history.....	302-303
Gun.....	304
Recoil mechanism.....	305-306
Elevating mechanism.....	307-309
Traversing mechanism.....	310-314
Gun carriage.....	315-316
Railway car body.....	319
System of anchorage.....	320-321
Trucks.....	322
Ammunition supply system.....	323-326
Table of classified data.....	327

FRENCH ARTILLERY.

120-MILLIMETER GUN.

1. The history of the carriages on which these pieces are mounted is interesting. The first concrete results of interest to French designers and experimenters in railway artillery seems to have been the work of General (then Colonel) Peigne, under whose direction a number of mounts of the style shown on Plates 1, 2, 4, and 5 were made up in 1888. They were known specifically as Schneider-Canet-Peigne mounts. No record has been found with reference to their use by France in any wars prior to the recent war. A number of them were made by the Schneider Co., however, for the Government of Denmark, for use in the defense of their coast. The mounts were exhibited at the Paris exposition in 1900 and the descriptive booklet from which Plate 1 is taken was made up at that time.

2. The desperate need of the armies on both sides of the line in the conflict just passed is apparent from the fact that both used practically any gun that would shoot and practically any carriage that would satisfactorily carry the gun. The writer found among the captured German artillery some bronze cannon of a very crude type mounted on wood carriages without any recoil mechanism. These same cannon had probably been used in the war of 1870. On the other hand, our own forces used the guns and carriages shown on Plate 4. These were photographed in the arsenal at Toul where they had been parked after we had finished using them in the sector north of Toul. No record has been seen with reference to the effectiveness of their service; this is probably the only actual warfare that these mounts have seen, however. On Plate 4 an improvised engine can be seen in front of the mount. This is a gas engine mounted on a four-wheeled truck and furnished the motive power for maneuvering the mounts on the front.

3. *Recoil mechanism.*—The one feature that impresses one as most unique and of greatest interest on this mount is the recoil mechanism. For a mechanism of the period of 1888 it embodies some admirable and ingenious features. The details are seen best on Plates 1 and 2. There are three distinct subdivisions to the mechanism. These are, first, two hydraulic cylinders, Plate 2, embodied in the top or gun carriage, to check the recoil of the gun and its carriage as they slide to the rear. The second feature is the vertical hydraulic

cylinder Y, lower figure, Plate 1, into which the vertical piston attached to the swinging carriage passes and by means of which the downward swing of the gun carriage is checked. The third is the pair of Belleville spring cylinders which operate in conjunction with the single hydraulic cylinder to check the downward swing of the carriage, and as soon as the recoil ceases they return the carriage to its normal position. There is nothing unusual about the first feature, but there is in the curious combination of the second and third. In

PLATE 1

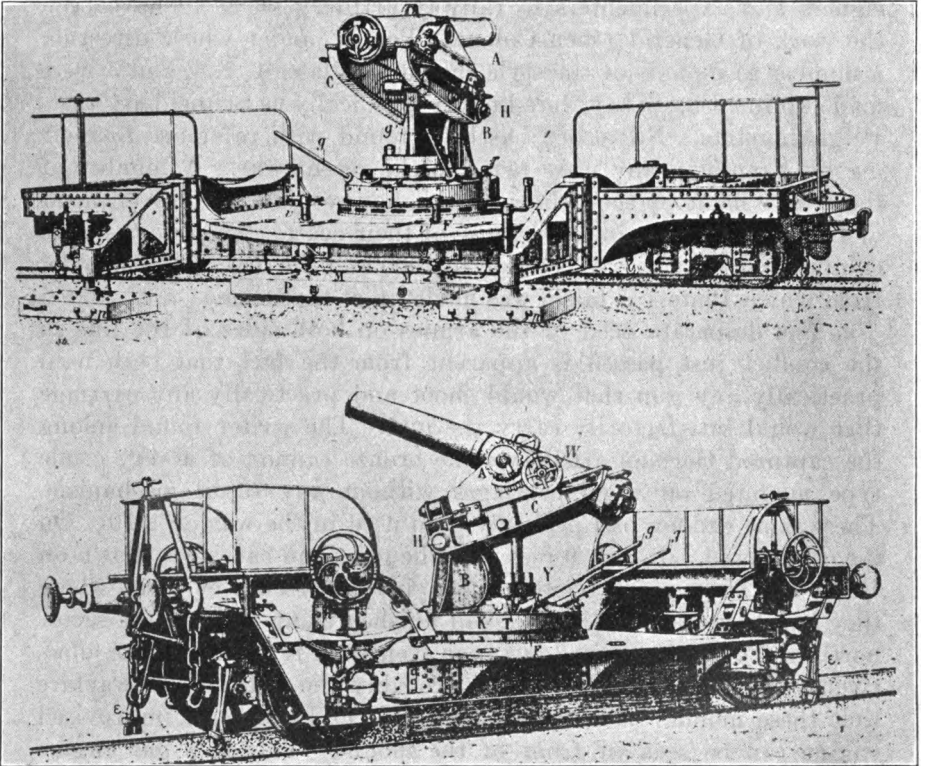

ALL ROUND FIRE RY. MTS., EARLY FRENCH DESIGN, SHOWING OUTRIGGERS AND RAIL CLAMPS.

lower figure, Plate 1, it will be seen that the vertical piston has on its end a head that fits snugly in cylinder Y and is perforated so that the glycerin may pass through it around the throttling rod as the piston moves downward. When the force of recoil is greatest the tendency of the liquid in the cylinder to force out either head operates in pushing out the floating gland T, the arms of which are attached to the two rods of the spring cylinders. The springs are thus further compressed until recoil ceases, when they pull in the rods, forcing

the floating gland back into its place. This compels the vertical piston to rise and the carriage to return to its normal position. The net result is, of course, to keep a considerable pressure on the liquid at all times. It is interesting to note that the Belleville springs were so early put to service in railway artillery.

4. *Traversing mechanism.*—The traversing mechanism seems quite crude, though it is accurate in its operation. The carriage is rotated into its approximated position through the use of two bars inserted in two sockets. When the gun is approximately laid in azimuth

PLATE 2

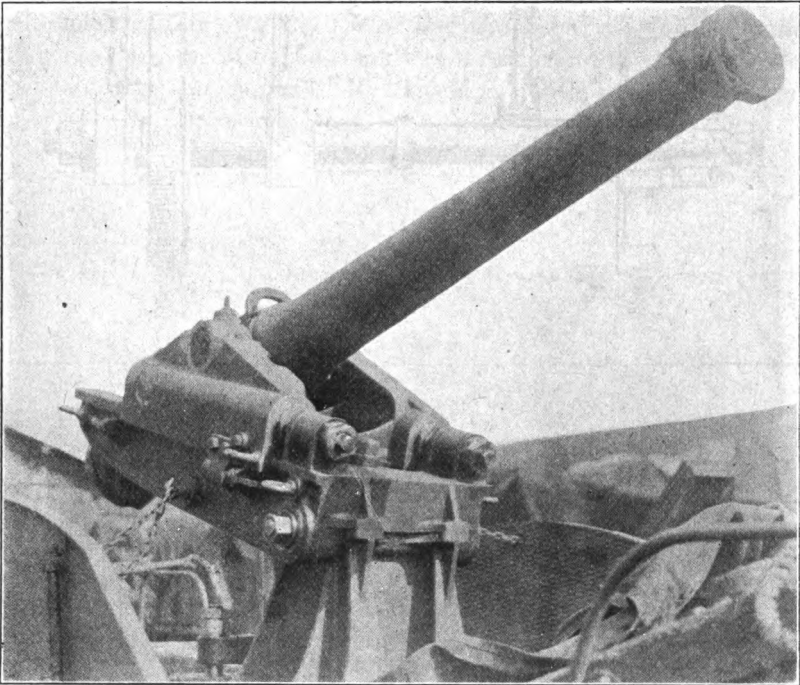

120-MM. RIFLE ON PEIGNE-CANET CARRIAGE SHOWING PARALLEL RECOIL CYLINDERS.

the clamp of what may be termed a fine adjustment mechanism is drawn and the carriage set accurately by means of a screw, Plate 5.

5. *Trucks.*—These mounts when photographed were on extra-narrow gauge trucks of only 60 centimeters. Plate 3 shows Colonel Peigne's original idea for operating the mounts on tracks of 1 meter and 1.45 meters gauge. By an ingenious method of sliding the wheels outward on the truck axles the narrow, or 1-meter, gauge can readily be changed to standard or 1.45 meters.

155 HOWITZER.

6. The history of these mounts is identical with that of the previously discussed mount. Apparently the design was made originally to take either the 120-millimeter gun or the 155-millimeter

PLATE 3

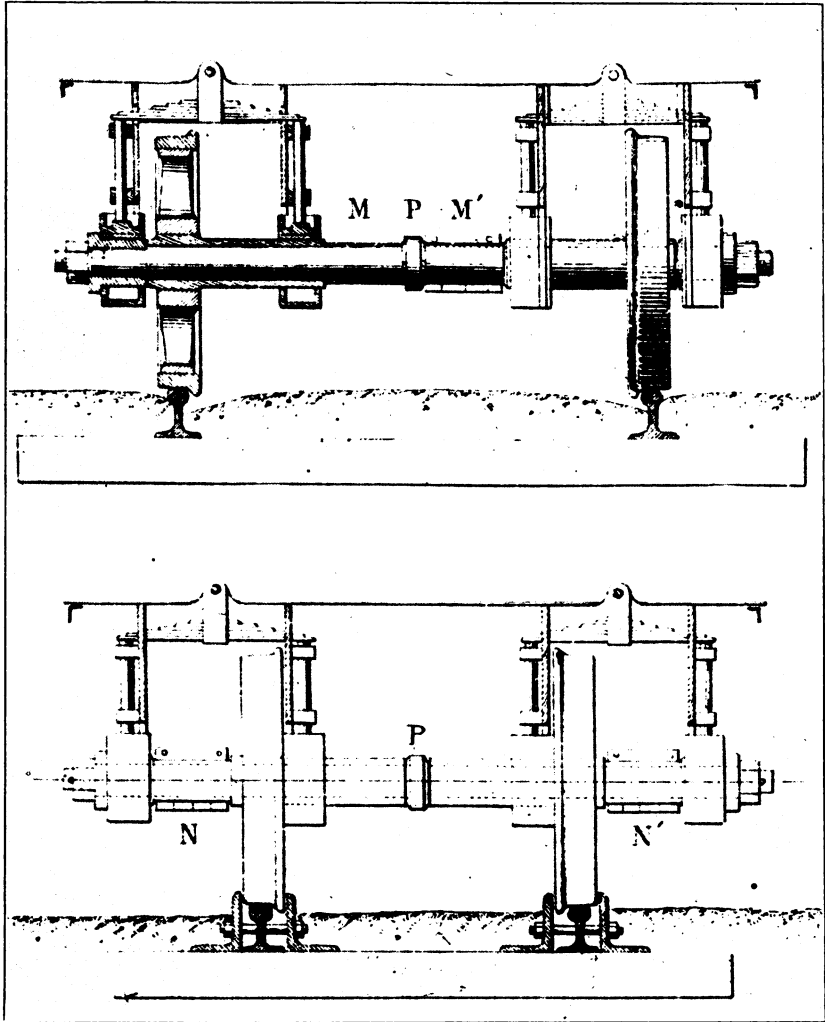

METHOD OF ADJUSTING TRUCK WHEELS FOR DIFFERENT GAUGE TRACKS.

howitzer, since either piece can be mounted on the carriage without any special provisions.

7. *Car body.*—As mentioned in paragraph 5 these mounts were equipped with 60-centimeter trucks. This fact rendered them of

greatest service in consideration of their range. The car body is of the drop frame type, is made of steel throughout and is supported on two four-wheel trucks of very sturdy design. In the center and on both sides there is a hinged platform that travels in a vertical position, Plate 4. These platform extensions are necessary in operating the gun at wide angles to the truck, since all operation of the gun must be from the floor of the car.

8. *System of anchorage.*—An observation with reference to developments in design during the war may be of interest here. The Schneider sliding type of carriage is thought of as new, whereas the principle of permitting the mount to recoil on the track was a development of our own Civil War and the use of sleepers to transmit the shock of recoil to the track was a feature of the mount under discussion if it was not actually developed with it. Two sleepers

PLATE 4



OLD PEIGNE-CANET MOUNT USED BY AMERICAN FORCES IN LATE WAR.

are provided with each mount and are inserted between the low center section of the car and the rails. In addition there are two hinged outrigger arms on each side with screws through the ends, which are run down hard on iron-shod wood floats or pads about 18 inches square. These are, of course, to prevent overturning of the car when the gun is fired at wide angles to the track. This same principle of anchorage has been used on even the most elaborate of designs of this war. In some cases the principle has been somewhat camouflaged, it is true, but it is nevertheless the same. Coming back to the observation started above it seems to the writer that the credit for the most significant new development in anchorage designs of the war must be given to the Germans. The reference here is to the hinged central pivot which served as a part of the traversing mechanism as well as a part of the anchorage of the 210, 240, and 280 millimeter, paragraphs 336-380, Volume 1.

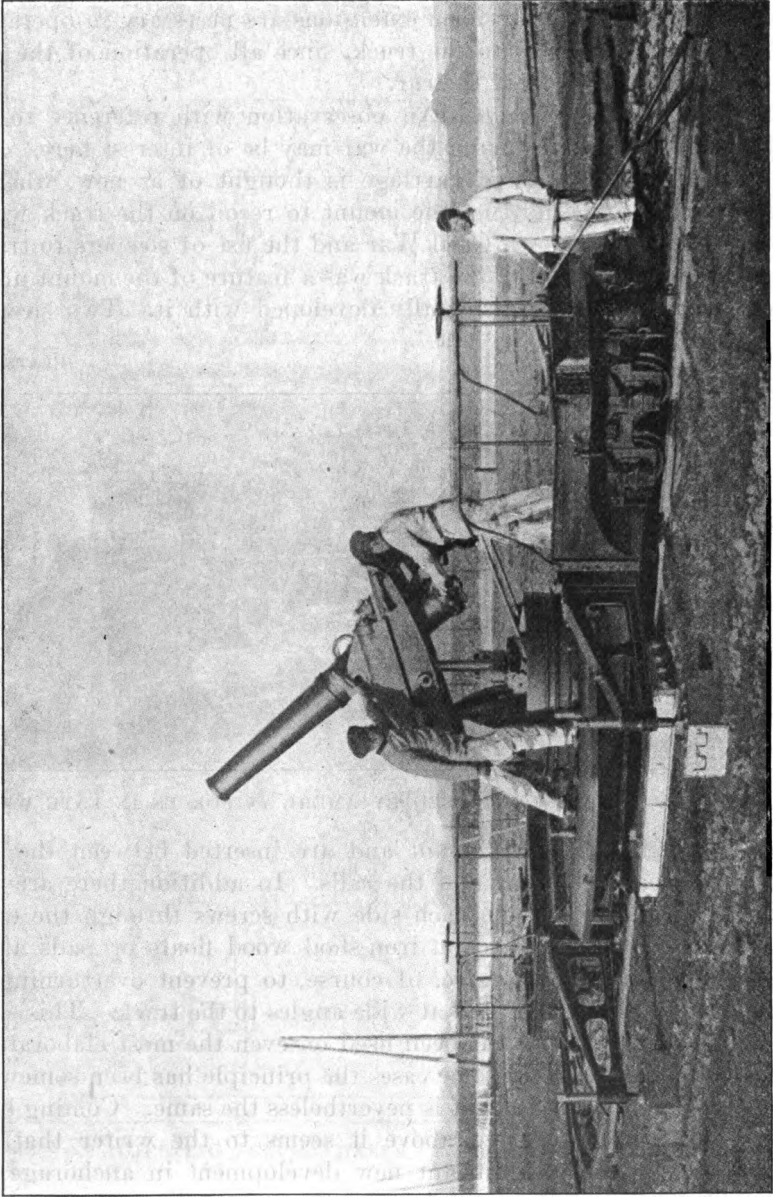

MOUNT FOR 155-MM. HOWITZER AND 130-MM. GUN.

PLATE 5A

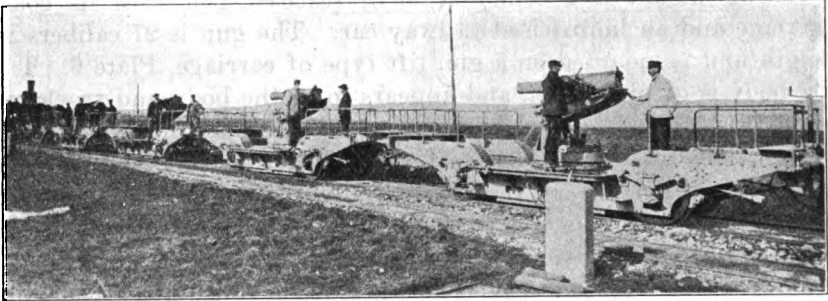

150-MM. HOWITZERS. PLATFORMS IN FIRING POSITION.

PLATE 5B



155-MM. HOWITZER MOUNT. WORKING PLATFORMS IN TRAVELING POSITION.

155 GUN.

9. This mount is a combination of seacoast gun with its coast carriage and an improvised railway car. The gun is 27 calibers in length and is mounted on a gun lift type of carriage, Plate 6. The car body is of plate steel, and appears to be the body and trucks of an extra-length standard railway car. There are no features of design that can be considered of value although some are interesting. It is simply one of the hurriedly improvised mountings for an existing seacoast gun and carriage, and after the supply of guns was exhausted was, of necessity, laid aside.

10. *System of anchorage.*—The system of anchorage embodies three separate features—a heavy timber pad directly beneath the gun, hinged outrigger arms, and rail clamps, Plates 6 and 7. It will be observed on Plate 6 that the timber pad directly under the gun carriage is let down onto the rails and the car body forced up slightly by means of the four screws passing through the floor of the car. The outrigger arms are attached to the ends of heavy wood beams passing entirely across the car, both above and below. The timber floats or pads are permanently attached to the screws on the ends of the arms and the whole is shown in traveling order on Plate 7. On Plate 6 two rail clamps can be seen near the outrigger arms. Each rail clamp is attached to a screw passing through the car body in order that the car may be drawn down tight to the track. With this quite complete system of anchorage the gun can, of course, be operated through its entire traverse of 360 degrees.

164.7-MILLIMETER GUN.

11. All of the guns mounted on the carriage that comes under this heading are naval guns of 45 calibers length. They were made available early in the war when it was apparent that the German fleet would be comparatively inactive. The use of guns of this caliber of which there was no duplicate for land service brings up an interesting side issue. In 1918 the 155-millimeter G. P. E. guns were wearing out so rapidly under the excessive service that the manufacturing facilities in France were not sufficient to provide replacements, tube renewals, and additional guns for new troops. One of the solutions that was advanced was to rebores the 155-millimeter guns to 164.7, shrink on an extra hoop at the breech, and increase the powder charge sufficiently to retain the 155-millimeter range, and use the existing railway gun projectiles. Had the armistice not intervened it is not improbable that this solution would have been adopted.

PLATE 6

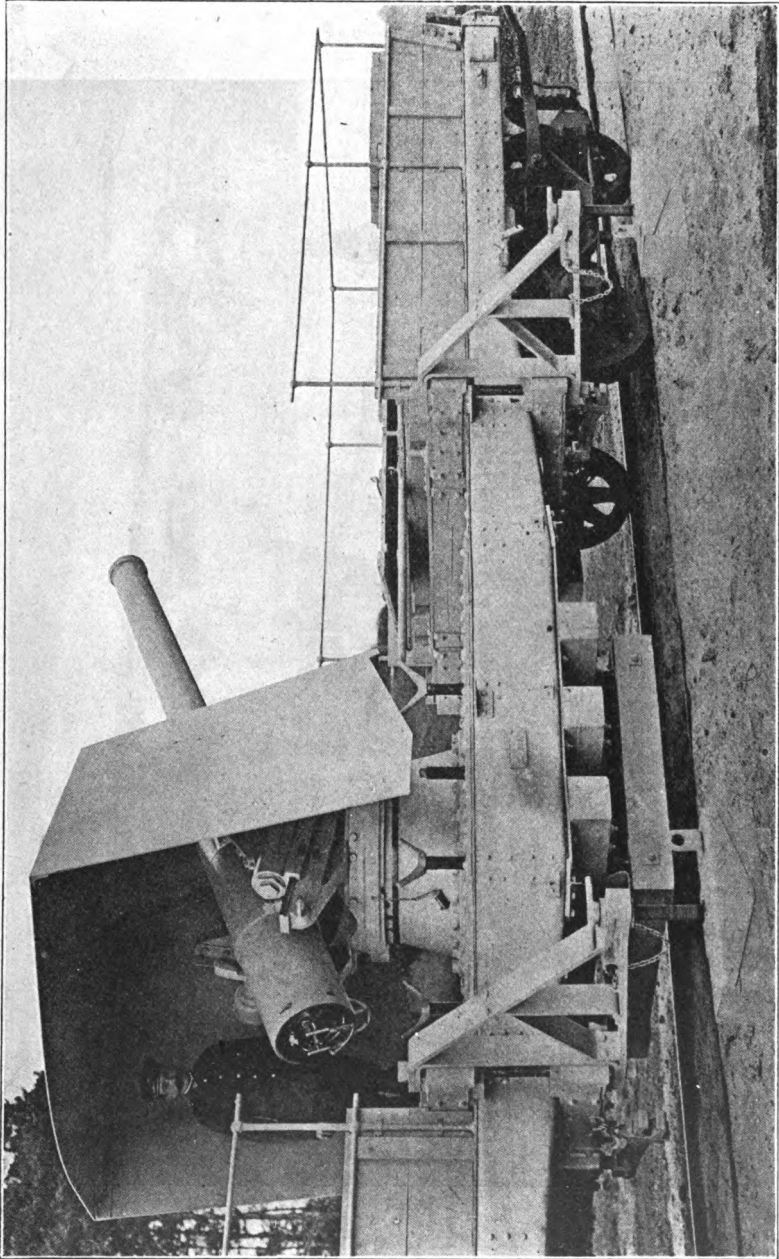

155-MM. SCHNEIDER CARRIAGE MOUNTED ON CONVERTED STANDARD RAILWAY CAR.

PLATE 7

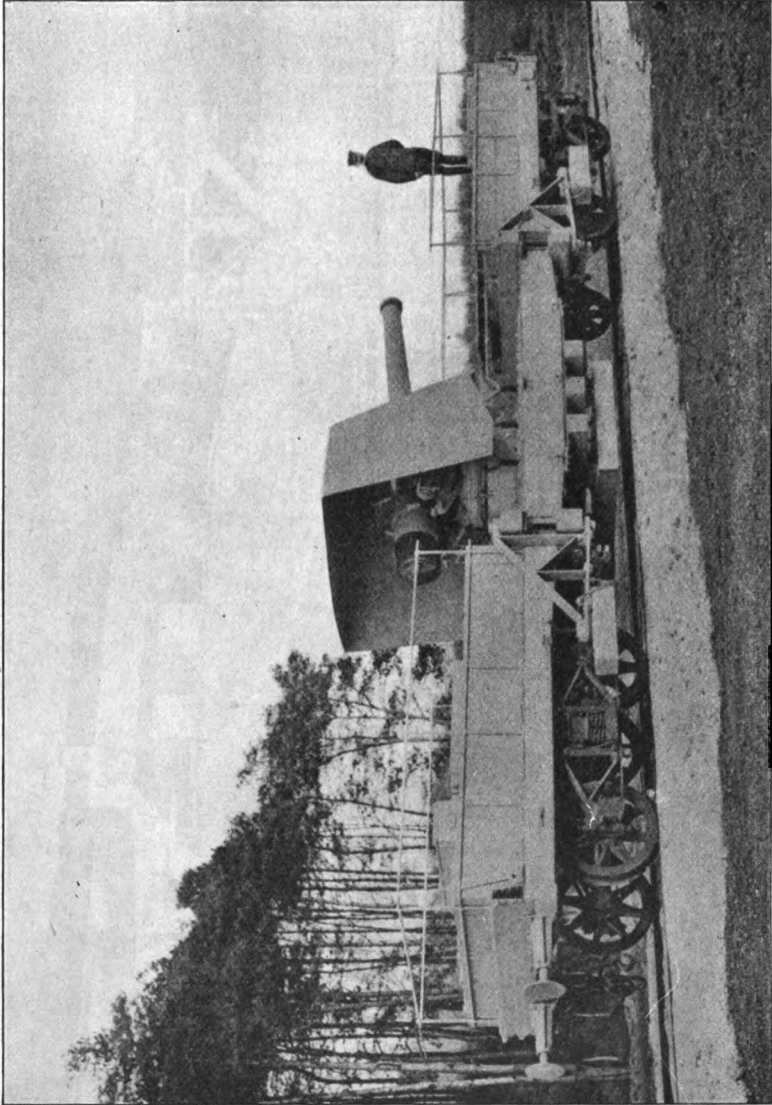

OUTRIGGERS SECURED FOR TRAVELING.

12. This is the first mount observed on which the ammunition is stored on the car. It will be observed on Plates 8, 9, and 10 that a steel ammunition storehouse has been constructed on each end of the

PLATE 8

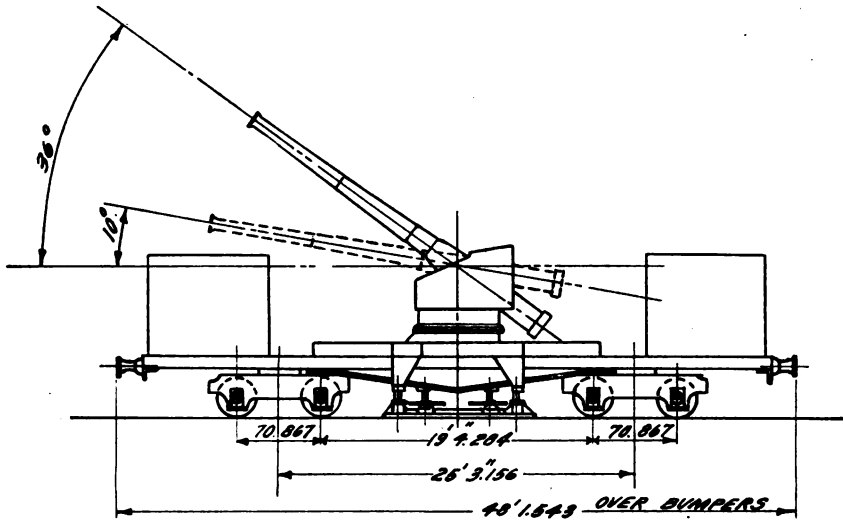

ARRANGEMENT OF MAGAZINES ON EACH END OF CAR.

car body. No special provisions were necessary for the handling of the ammunition, since two men could easily handle a projectile in a tray. The car body is of special design, steel throughout, and

PLATE 9

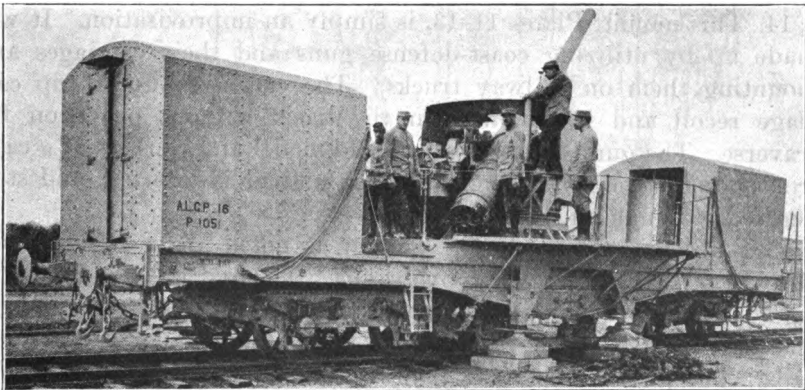

OUTRIGGERS AND WORKING PLATFORMS IN POSITION FOR ACTION.

again includes the hinged extension working platform on each side in the center. It is believed that the trucks are simply standard railway trucks of quite heavy design.

13. *System of anchorage.*—On Plate 9 the mount is seen anchored for service. To the best of the writer's knowledge there is no other mount in the French service which has the central anchorage mechanism so close in. The screw housings are attached directly to the side of the car. The screws are forced down on iron caps resting on wood pads or floats. In addition there are eight rail clamps—four in the center of the car and two at each end—to prevent too great vibration of the car on recoil or counterrecoil of the gun. This system of anchorage seems to have answered quite well, for the guns and mounts saw heavy service.

PLATE 10

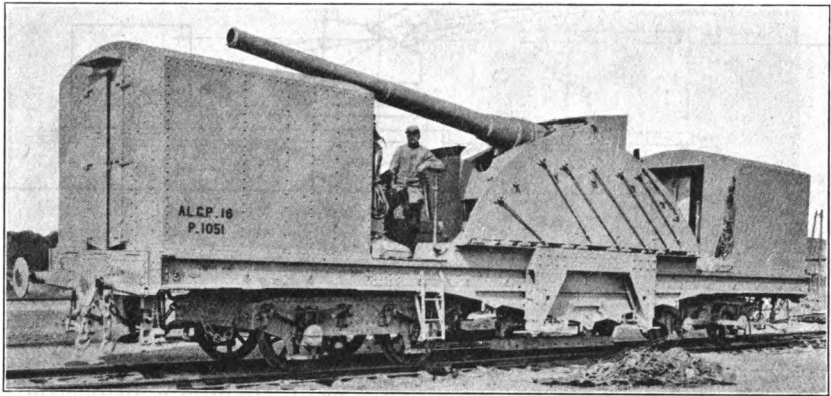

READY FOR TRANSPORTING.

194.4-MILLIMETER HOWITZER, MODEL 1875, 1876.

14. This mount, Plates 11–13, is simply an improvisation. It was made up by utilizing coast-defense guns and their carriages and mounting them on railway trucks. The carriage affords top carriage recoil and is mounted on the truck without provision for traverse. The gun tube is of a very old model and consists of a cast-iron body, at the breech end of which a liner is inserted, and steel hoops are shrunk on the outside.

15. *Recoil mechanism.*—This mount as noted above has top carriage recoil. Counterrecoil is by gravity. The hydraulic buffer cylinders, Plate 14, are about 9 inches outside diameter by 6 feet in length and are attached to the car body just beside and under the inclined rails. The piston rods are 2 inches in diameter and are attached by means of 2-inch pins to the gun carriage near the rear end. The gun carriage rolls in recoil up a pair of rails and apparently can recoil a distance of about 4 feet. The four wheels on which the carriage is supported are 15 inches in diameter by 4 inches in width and are mounted on axles 6 inches in diameter.

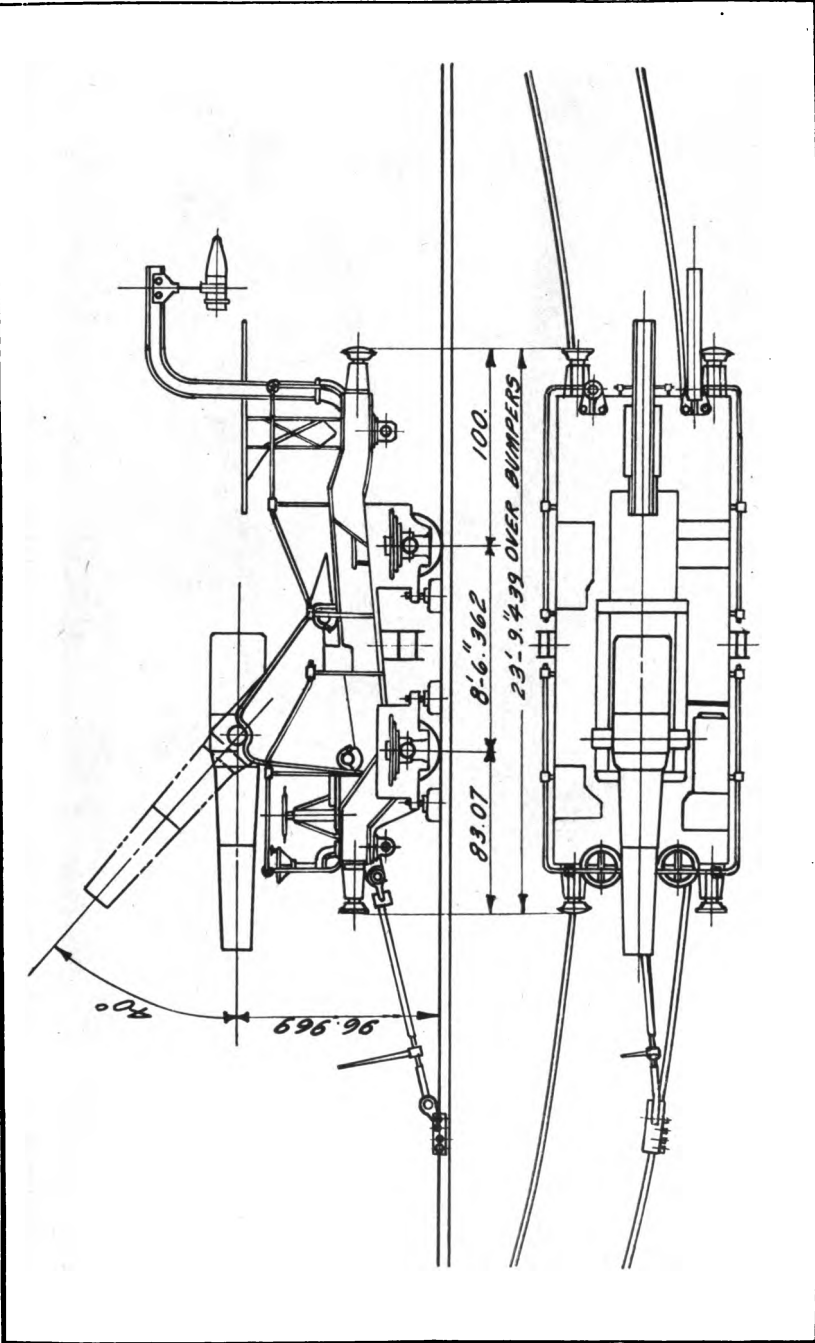

ELEVATION AND PLAN OF SCHNEIDER 190-MM. HOWITZER WITH RAIL CLAMP AND TRUCK JACKS IN PLACE FOR FIRING.

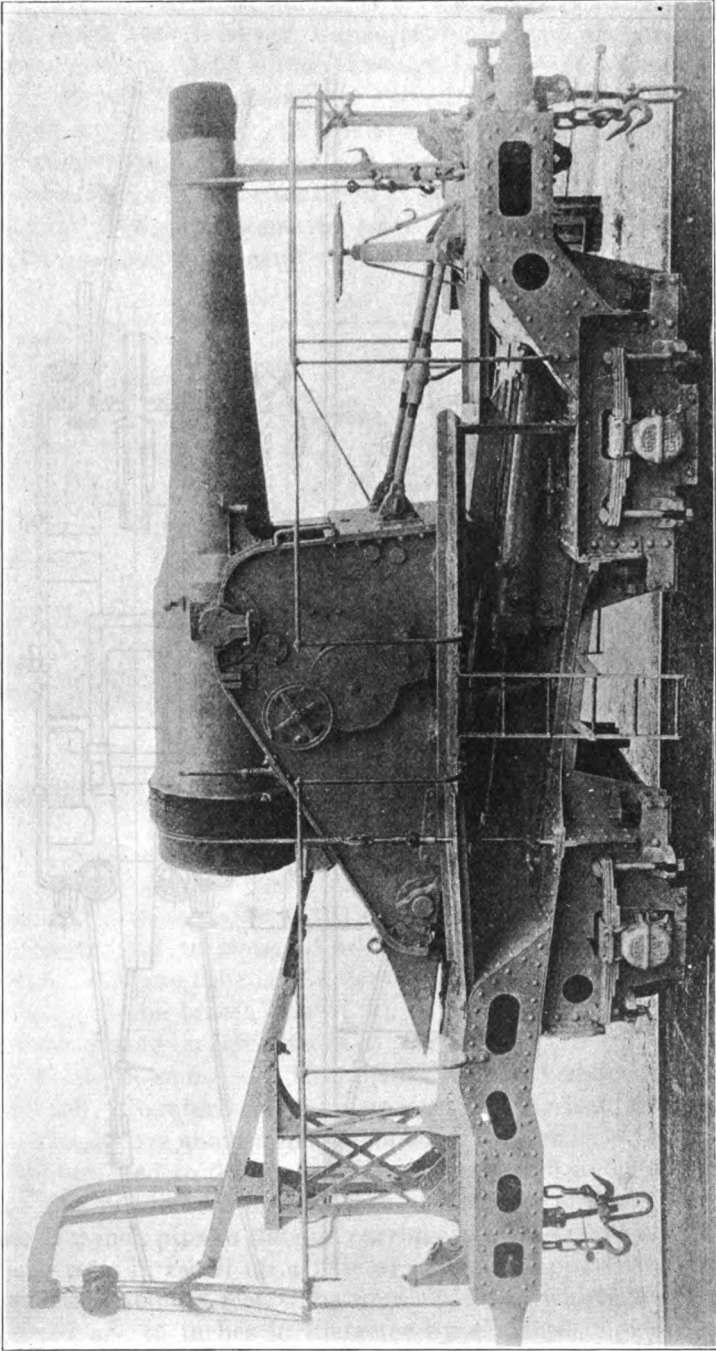

190-MM. HOWITZER MODEL 1875. TOP CARRIAGE RUN BACK AND HELD BY ADJUSTABLE STRUT RODS WHEN TRAVELING, THUS DISTRIBUTING WEIGHT EQUALLY ON BOTH AXLES.

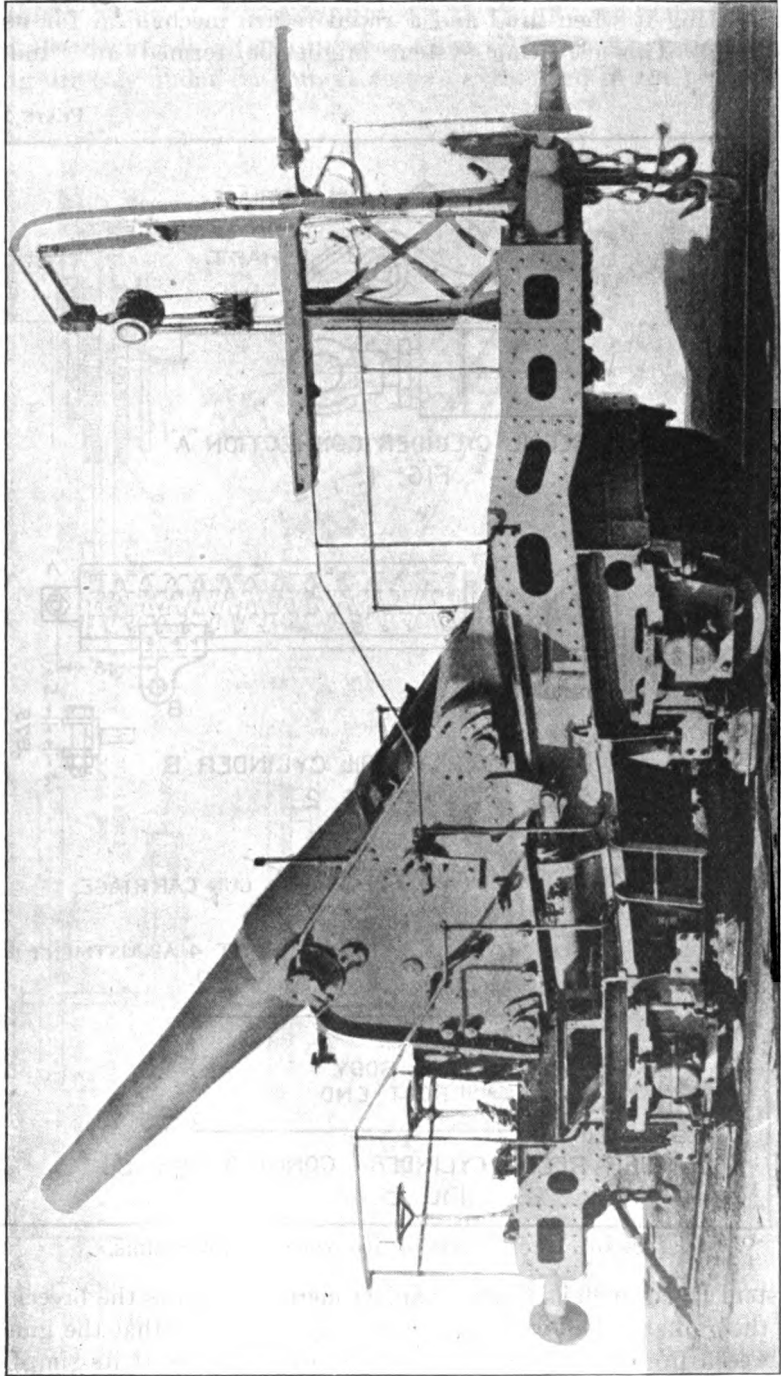

190-MM. HOWITZER MODEL 1875. FIRING POSITION.

16. *Elevating mechanism.*—The elevating mechanism is in duplicate, including a slow, heavy mechanism for elevating the piece and supporting it when fired and a rapid return mechanism for use in loading. This elevating system might be termed an “indirect

PLATE 14

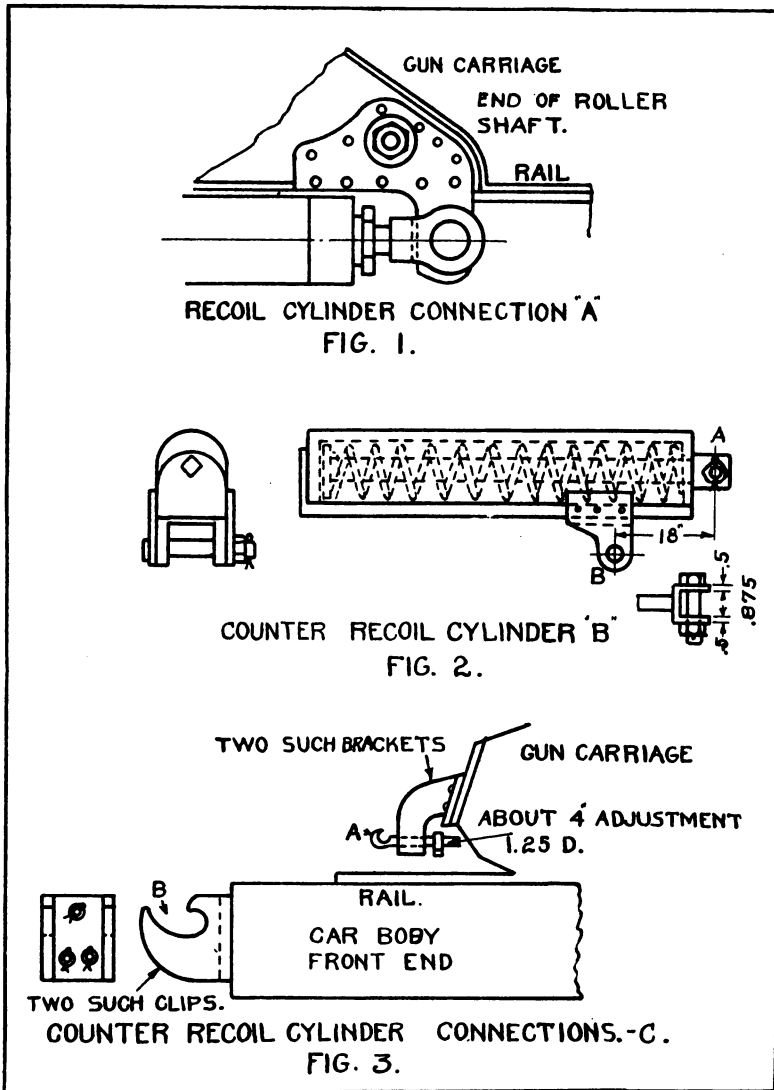

RECOIL MECHANISM OF 190 AND 240 HOWITZERS.

system" inasmuch as the mechanism merely supports the breech end of the gun and the operation depends upon the fact that the gun has a breech preponderance. This mechanism, because of its simplicity of construction, is worthy of consideration; it seems crude but it

works. The main elevating mechanism consists of two plates .625 inch thick, Figure 1, Plate 15, pressed to the desired shape, with a steel elevating rack riveted between them. This rack arrangement is hung directly under the gun from two axles fixed in the two side

PLATE 15

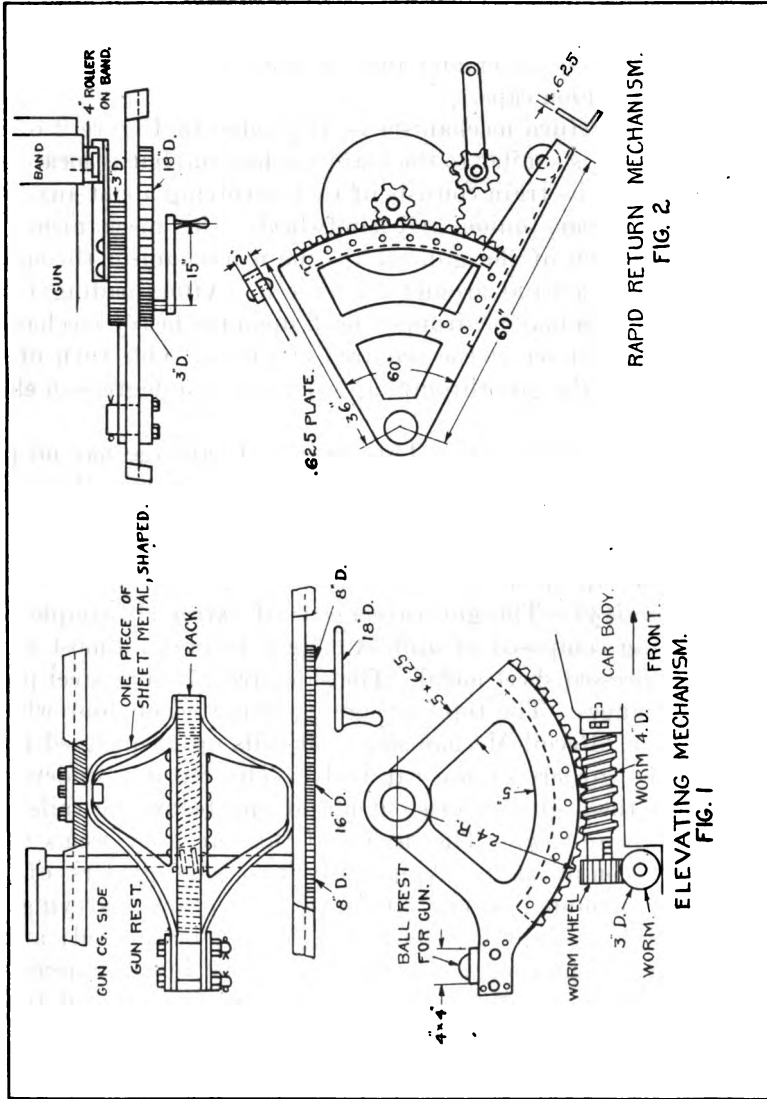

SKETCHES OF SLOW AND FAST MOTION ELEVATING MECHANISMS OF THE 190 HOWITZER MODEL 1875.

frames of the gun carriage just below and to the rear of the trunnions. The ball rest, shown in Figure 1, bears against the underside of the gun at the breech end and holds it at the desired elevation. This rack meshes into a worm which, through a worm wheel and

another worm, a gear and an idler gear, leads to a handwheel. Most gear ratios are given on the sketch. It should be added that the rack has approximately 1.25 teeth per inch and the pinion on the 4-inch worm shaft has 14 teeth. The ratio of movement is not constant, but one turn of the handwheel moves the gun through approximately 0.14 degrees. No antifriction device is employed and trunnions, attached directly to the gun, are 18 centimeters long by 20 centimeters in diameter and rest in semicircular trunnion bearings without trunnion caps.

17. The rapid return mechanism is illustrated in Figure 2 of the same plate. This is similar to the main mechanism, but is located on one side only, and its train consists of rack revolving about auxiliary bearing, pinion, gear, pinion, and handwheel. This mechanism simply lifts the breech of the gun off the main mechanism through a roller carried by a band around the breech. After loading is accomplished the gun may be dropped back upon the heavy mechanism which has been left set at the required elevation. One turn of the handwheel moves the gun through approximately 5 degrees in elevation.

18. *Traversing mechanism.*—This design of carriage has no provision for traversing the gun. It is necessary to operate the mount on a curved track, where any desired traverse may be obtained or on a special platform made up of heavy timbers. A platform was used with success late in the war.

19. *Gun carriage.*—The gun carriage is of extremely simple construction, being composed of approximately 10 parts, almost all of which are of pressed sheet metal. The sides are .875 inch steel plates with 4-inch flanges. The top carriage is supported on four wheels, as noted under "Recoil Mechanism," and rolls up an inclined track formed on the girders of the car body. The recoil cylinders are located along these girders just outside of and below the rails.

20. *Railway car body.*—The design of this car body seems to be unnecessarily complicated. Apparently two side girders of the desired shape, mounted on two structural steel beams, carrying the wheels and axles, might be substituted for the body used; at the ends any desired width might be given to the body for the necessary operation of the gun. Provision is made for placing road trucks under both the front and rear ends, thereby converting the mount into a tractor-drawn mount. For somewhat similar road equipment see Plate 53.

21. *Anchorage.*—During firing the mount is supported on three cross beams or sleepers extending across the track, one in front and the other two between the axles. These beams are of wood, but are shod with steel plates and provided with a handle and socket at each end,

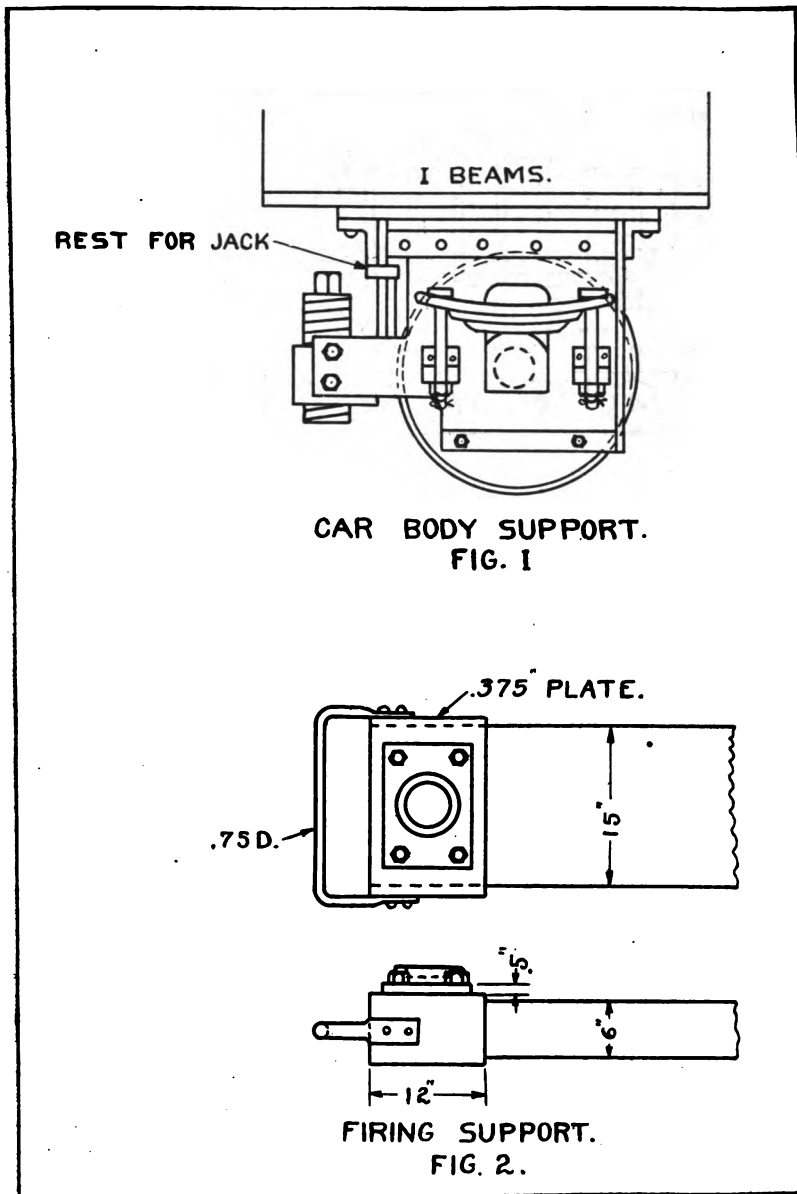

TRACK EQUIPMENT FOR THE 190 AND 240 HOWITZERS.

Figure 2, Plate 16. (Six 4-inch screws are provided in the position shown in Figure 1 of the same plate. The sleepers are placed across the rails under the screws and the latter run down until the weight of the mount is partially transferred from the wheels to the sleepers.

PLATE 17

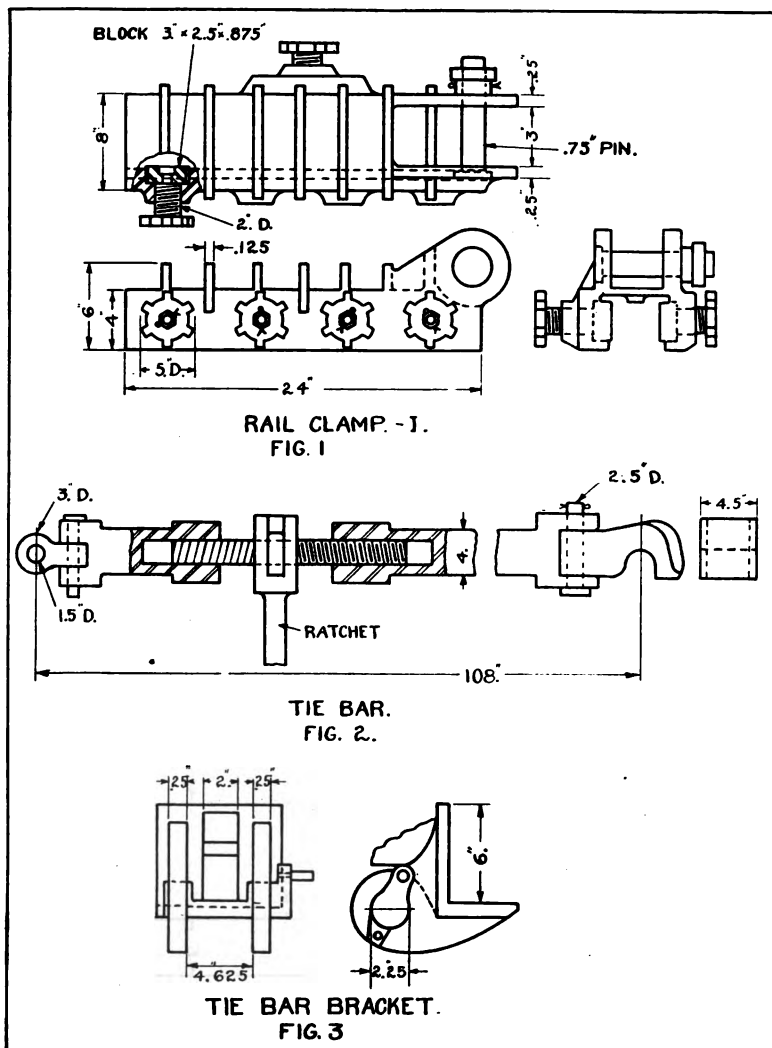

DETAIL SKETCHES OF RAIL CLAMP.

To prevent the mount sliding along the track on firing, a rail clamp, Figure 1, Plate 17, is provided. It is attached to the outside rail of the curve and is connected to the car by means of the tie bar, Figure 2. The eye end of the bar is connected to the clamp and the

hook end to the bracket on the front of the car, Figure 3. It will be noted that half of the pin is cut away; it is shown in the position for inserting the hook; half a turn to the left locks the hook in place. The rail clamp usually slips a little at the first few shots, but when the slack is taken up the mount is held in place.

22. *Trucks.*—The railway car itself is really the truck. Cast-steel boxes slide up and down in the slots of plates riveted to the car body and support the latter through semielliptic springs.

23. *Ammunition supply system.*—At the rear end of the car an ammunition table, Plate 11, is built in place. The projectile is transferred to it from the ground by means of the jib crane made of a 6-inch I beam. Two sockets are provided, so that the crane can be mounted on either side of the car. A tray is provided of sufficient length to reach from the ammunition table into the breech of the gun; the projectile is slid forward on this tray and rammed by two men.

194.4-MILLIMETER HOWITZER, MODEL 1875-76 ON CARRIAGE, MODEL 1917.

24. This mount, Plates 18-19, is of the same general type as the preceding though it is not adapted for road transportation and the frame of the car is horizontal and straight instead of inclined and broken. The gun is the same, as well as the top carriage, both of which were removed from coast fortifications. This mount represents an improvement over the preceding in the sturdiness of the car.

25. *Recoil mechanism.*—This mount as the preceding has top-carriage recoil. The top carriage consists of triangular structural steel side frames connected by front and rear transoms and mounted on four rollers, each about 15 inches in diameter. These rollers rest on two horizontal metal rails mounted on the top of the car body, and the top carriage rolls back along them for a distance of about 42 inches. The recoil cylinders are two in number and are located one on each side of this car body, Figure 1, Plate 14, just outside of and below the rails on which the top carriage rolls. The carriage is returned to its normal position by either a steel spring mechanism, Figure 2, Plate 14, or by rubber bands carried in the same type of cylinder and connected in the same way. The novel experiment of using rubber bands came about because of the extreme difficulty from the breakage of the steel springs in cold weather. Each of the cylinders carried 12 cotton covered bundles of 700 rubber bands each. The counterrecoil with rubber bands is slow but quite satisfactory and there was no trouble through breakage.

26. *Elevating mechanism.*—See same for the preceding mount, and Plate 15.

27. *Traversing mechanism.*—This material is designed to fire from a curved epi, as shown on Plate 18, and no traversing mechanism is provided. Further, the piece is so light that the French have improvised a firing platform, Plate 19, which can be installed more quickly than an epi and which allows 60 degrees traverse. This consists of a wooden platform about 5.5 meters square, with a half circle of railway rail 2.4 meters in radius spiked down on top of it. A small portable turntable or pivot is provided, to which the weight of the mount can be transferred by means of the jack screws and sleepers. The mount is brought up on the main track, and a temporary branch track at right angles is laid to and over the firing platform. The mount is transferred to this track by jacking it up,

PLATE 18

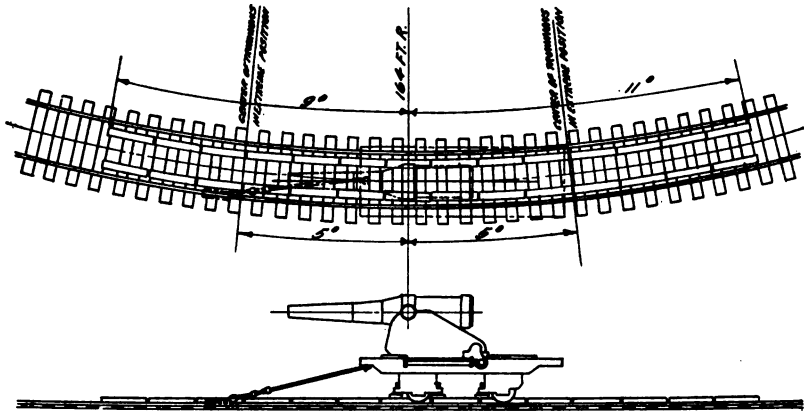

CURVED EPI FOR NON-TRAVERSING MOUNTS TO OBTAIN AZIMUTH.

putting it on the pivot, turning it around, and lowering it on the branch track rails. It is then rolled onto the firing platform until its center of gravity is just over the center of the semicircular rail mentioned above. Wood stringers are placed between the wheels, the sleepers are jacked down onto them, and the temporary branch rails are removed. The car is anchored to the semicircular rail by guys. After the pivot is replaced the mount may be traversed after being lowered to it. For firing, the mount rests on the stringers, through sleepers and jack screws, while the guys transfer the horizontal recoil force to the semicircular anchorage rail. For traversing, the weight is transferred to the pivot, the entire mount is turned by hand or by turnbuckles and guys, and then let down.

28. *Gun carriage.*—See same for preceding mount.

29. *Railway car body.*—The railway car body, Plate 19, is really a simple 4-wheel truck built up of structural shapes and rails.

PLATE 19

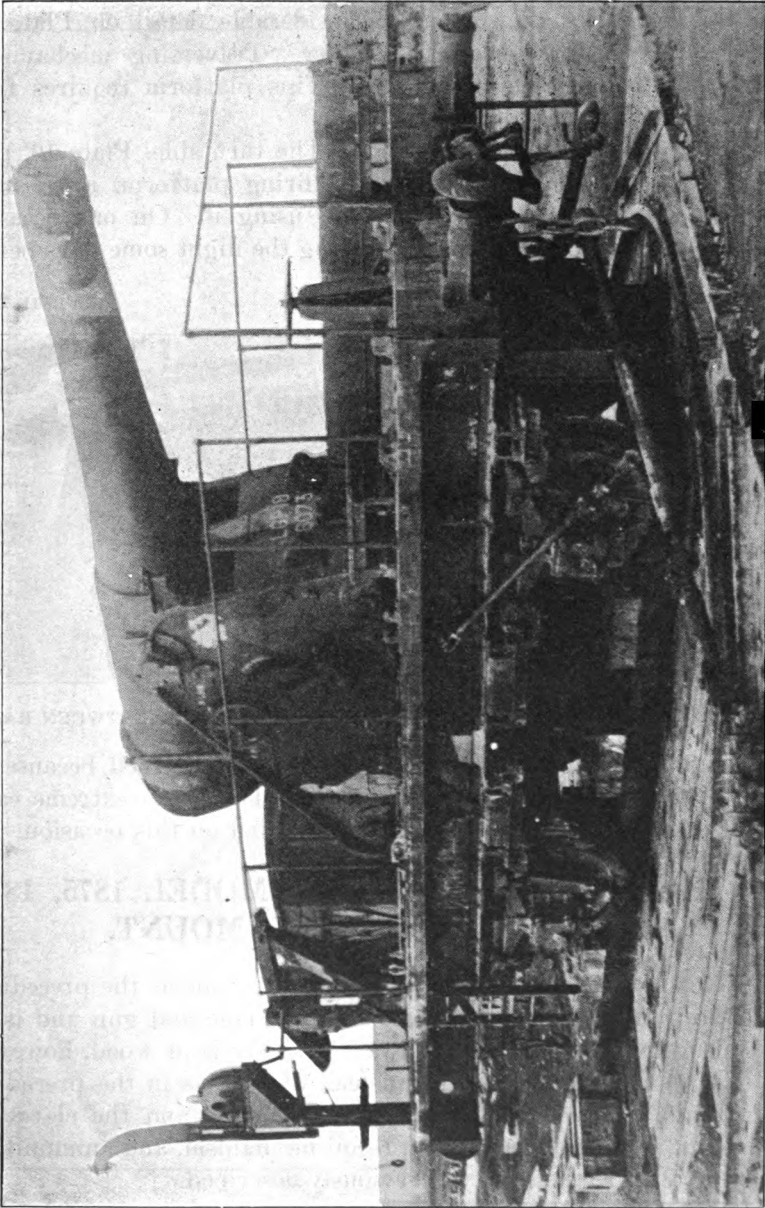

194.4-MM. HOWITZER ON FIRING PLATFORM.

The wheels are 1.05 meters in diameter and are connected to the car body by semielliptical springs, Plate 20.

30. *System of anchorage.*—When the mount is fired from a curved track the operation is exactly the same as that of the preceding mount. The jacks are shown in considerable detail on Plate 20. The special platform explained under “Traversing mechanism” affords all the necessary anchorage. This platform requires from one to two days to install.

31. *Difficulties involved in service.*—The turntable, Plate 19, provided for use in connection with the firing platform, is so small that the greatest care is necessary in using it. On one occasion when a mount was being installed during the night some days before

PLATE 20

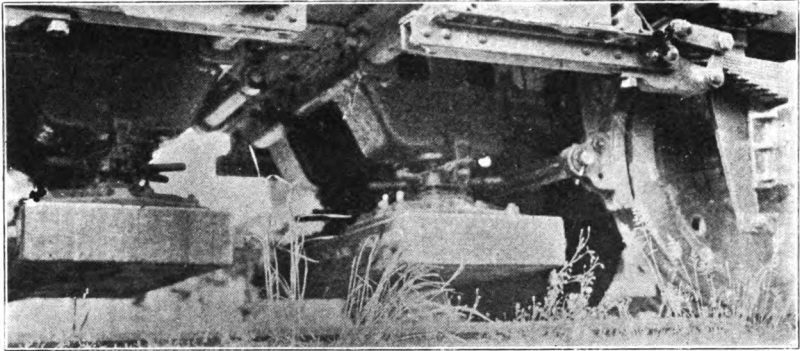

SCREW JACKS FOR CLAMPING DOWN ON FIRING PLATFORM BETWEEN RAILS.

the beginning of the St. Mihiel offensive it overturned because of lack of proper care in placing the pivot. This is an extreme case, of course, for lights were absolutely forbidden on this occasion.

194.4-MILLIMETER HOWITZER, MODEL 1875, 1876, 1878, ON THREE-AXLE MOUNT.

32. This mount, Plate 21, is in general the same as the preceding. It has been improvised from a sea-coast carriage and gun and is of the hydrogravity type. The railway car body is of wood, however, and is supported on three axles instead of two, as in the preceding two mounts. Three sleepers are used in firing, and the elevating mechanism, scheme of anchorage, recoil mechanism, and ammunition supply system are the same as previously described.

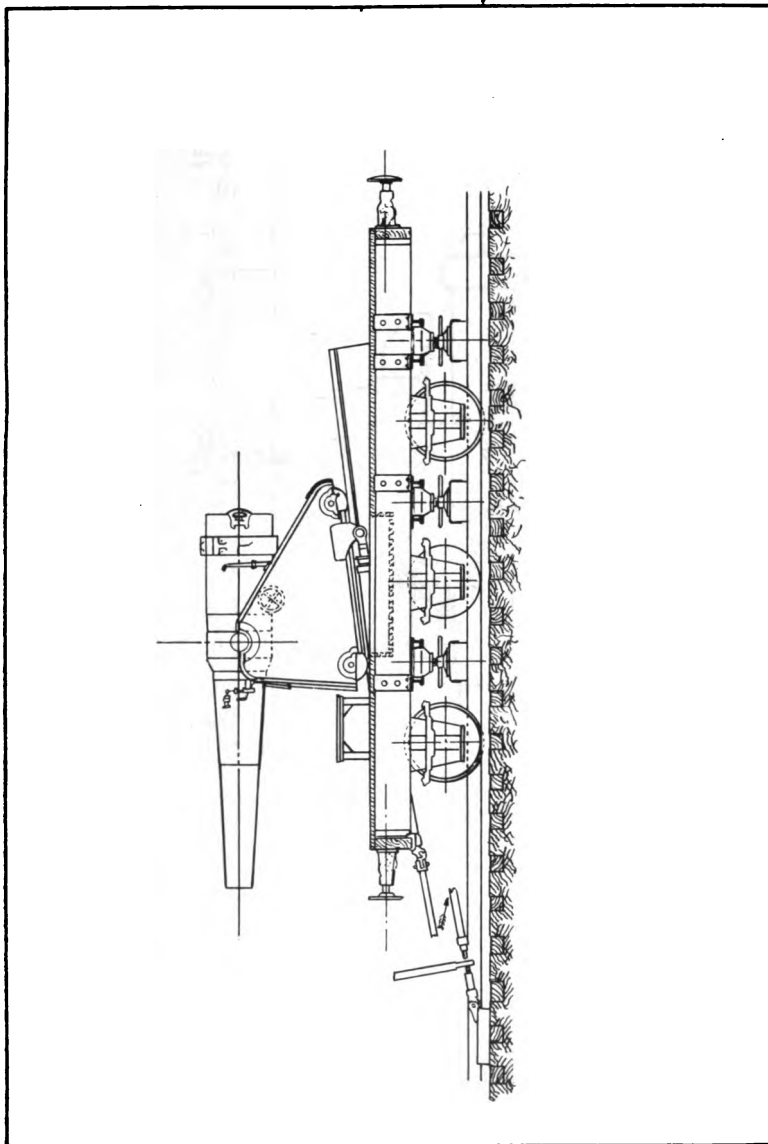

194.4-MM. HOWITZER ON THREE AXLE MOUNT.

194.4-MILLIMETER GUN, MODEL 1887, 1893, 1896, 1902.

33. This is another mount improvised from a seacoast gun on a gun lift, 360-degree traverse type of coast carriage. The exact

PLATE 22

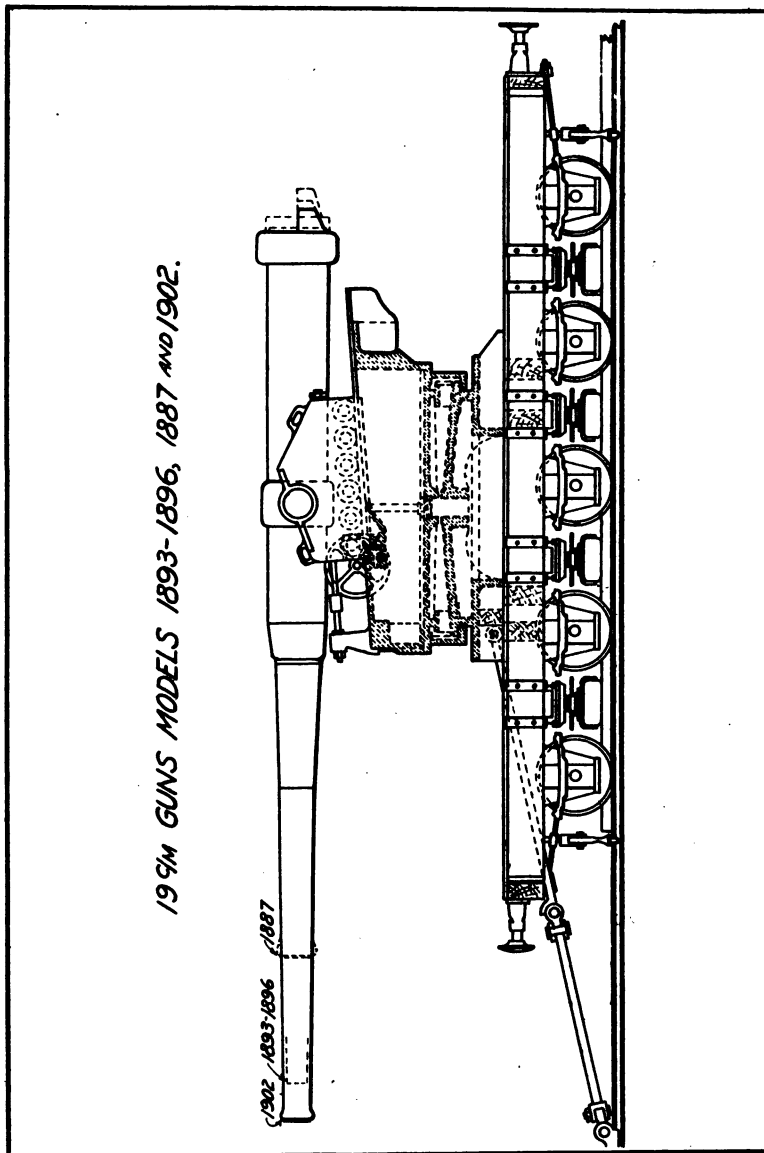

degree of traverse that can be used on the railway mount is not known; it is probably not more than 10 degrees on either side of the line of the track, however, since no special provision is made

for firing at wide angles. The car body is of wood and in firing is supported on four wood sleepers. Rail clamps and the guy rod previously described are also used. There are no features that seem worthy of description in detail. The mount is shown on Plate 22.

PLATE 23

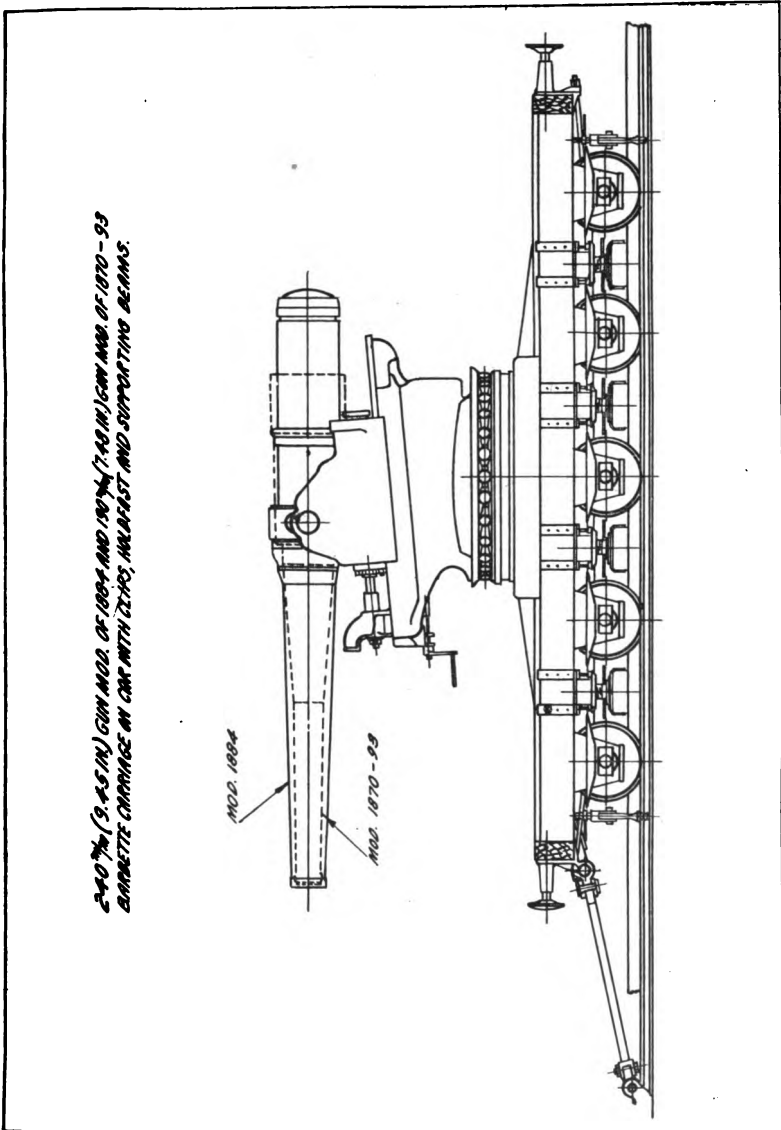

194.4-MILLIMETER GUN, MODEL 1870, 1893.

34. Examination of Plate 23 will show that this mount is quite similar to the preceding. The gun is shorter and the top or gun

carriage is slightly different in design. The railway car is almost identical, having five axles, four sleepers, similar rail clamps, and the same guy rod. The car body is constructed of wood.

194.4-MILLIMETER GUN, MODEL 1870, 1893, ON THREE-AXLE MOUNT.

35. The seacoast carriage used in making up this mount, Plate 24, is of the gun-lift type, but with its base ring would have made so high a mount as to exceed the railway clearances, hence the omission of any traversing arrangement. The car body is principally of steel, but with wood operating platforms. The mount must of course be operated on a curved track and is anchored by means of the already described type of wood sleepers and tie rod. Most of the features of this mount have already been described under other guns.

194.4-MILLIMETER GUN, MODEL 1870-1893, ON DOUBLE TRUCK MOUNT.

36. This mount, Plates 25-28, is again an improvisation from a seacoast gun and carriage. The gun consists of a cast-iron body with a steel liner and two rows of exterior hoops. The marine type of interrupted screw breech mechanism is used, and the firing mechanism is of the percussion type.

37. *Recoil mechanism.*—The recoil mechanism is of the top carriage hydrogravity type. The recoil cylinders are two in number and the top carriage recoils up the inclined rails of the chassis about 0.90 meter. The top carriage rests on the rails through four rollers.

38. *Elevating mechanism.*—The elevating mechanism is attached to the top carriage and recoils with it. It consists of a rack of about 0.80 meter radius, a pinion, two sets of bevel gears, and a handwheel. One turn of the handwheel (radius about 30 centimeters) moves the gun approximately 3 degrees in elevation. The maximum elevation obtainable is 30 degrees.

39. *Traversing mechanism.*—The chassis, or racer, on which the top carriage rolls, is supported in turn on four large rollers with axes arranged radially, Plate 27a. These roll on a suitable machined track on the base ring. A circular rack is provided on the base ring, into which meshes a pinion on the end of a vertical shaft carried by the racer. The traversing handwheel is mounted on a horizontal shaft and connects with this through bevel gears. The traverse allowed by the mechanism is 360 degrees, Plate 27, but it is probably impossible to realize that, due to character of anchorage, etc.

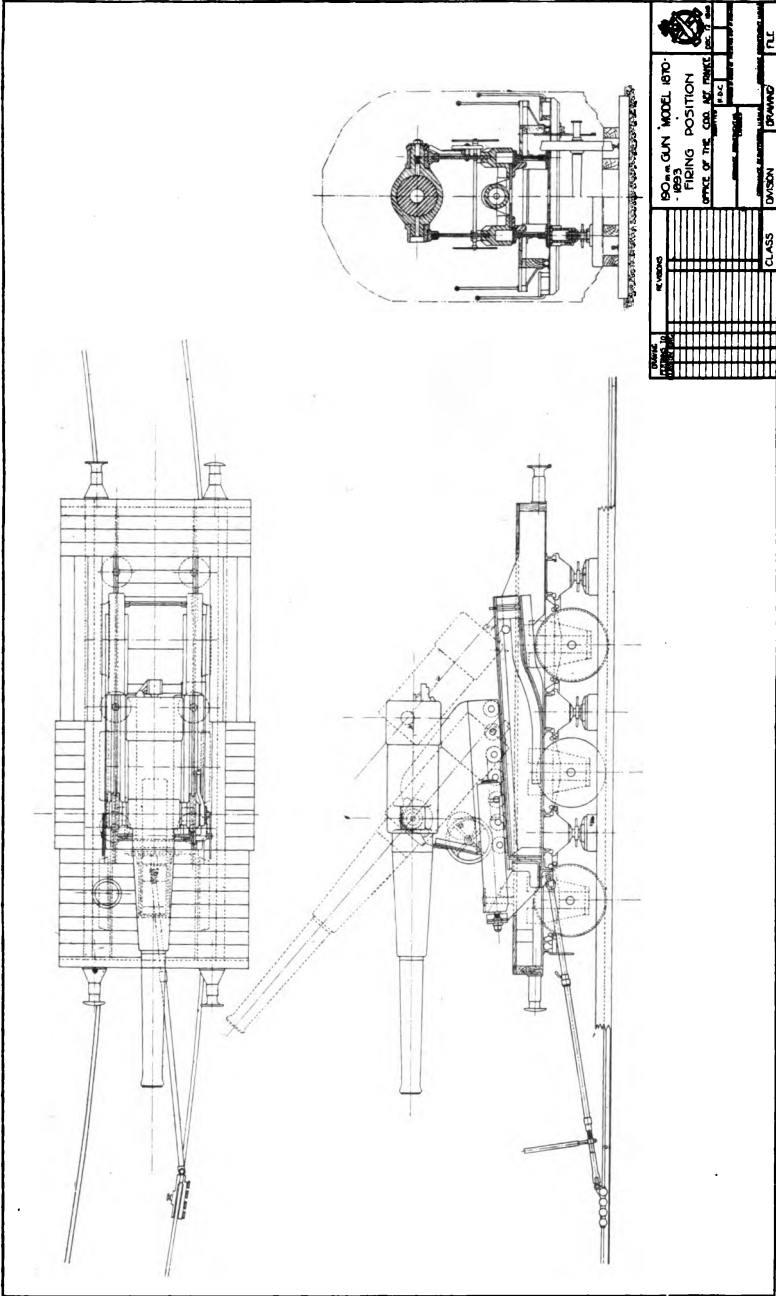

THREE AXLE CAR MOUNTING 194.4 MM. GUN MODEL 1870-1893 SHOWN IN ANCHORED POSITION.

194 7/8 (7.64 IN.) SCHNEIDER GUN 20.5 CAL. MOD OF 1870-93, ARMORED CAR, BARBETTE
 CARRIAGE SUPPORTED BY SCREW JACKS. TOP CARRIAGE RECOILING ON INCLINE CHASSIS

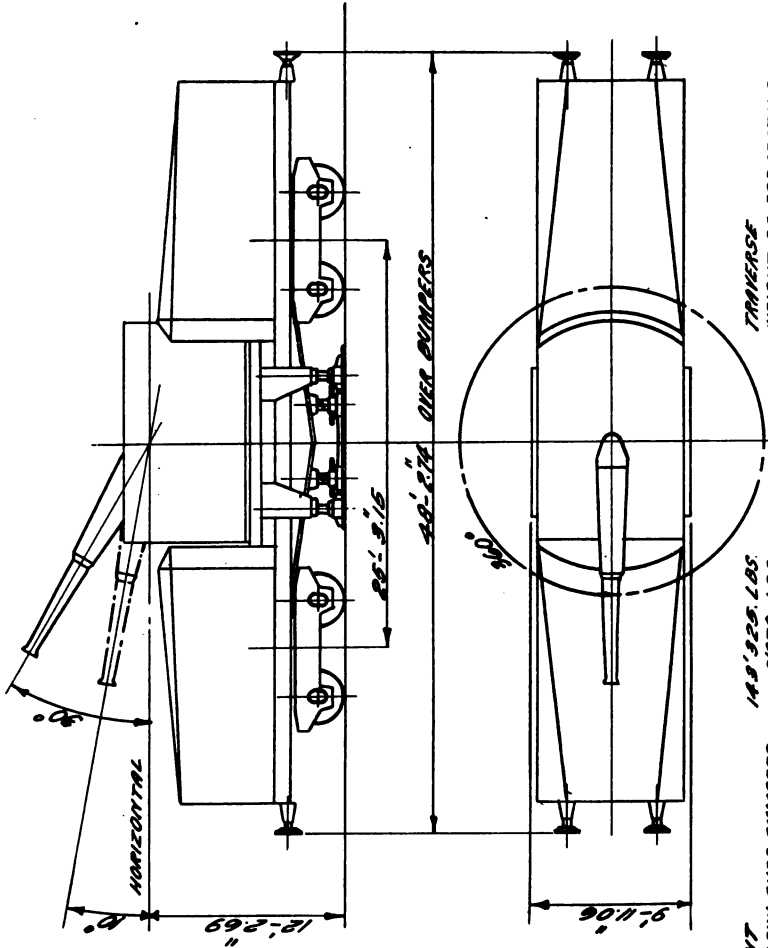

	DESCRIPTION	360°
TOTAL WEIGHT	143'925. LBS.	190. LBS.
WEIGHT PER FT. RUN OVER GUNNERS	2'970. LBS.	2977 LBS.
WEIGHT PER FT. RUN OVER BASE	12'100. LBS.	2068 FT.-SEC.
HEIGHT OF THE GUN	29'081. LBS.	10'040-12.5
ELEVATION	0 TO 50°	
	TRANSVERSE	
	WEIGHT OF PROJECTILE	
	WEIGHT OF POWDER	
	INITIAL VELOCITY	
	RANGE MAXIMUM	

PLATE 26

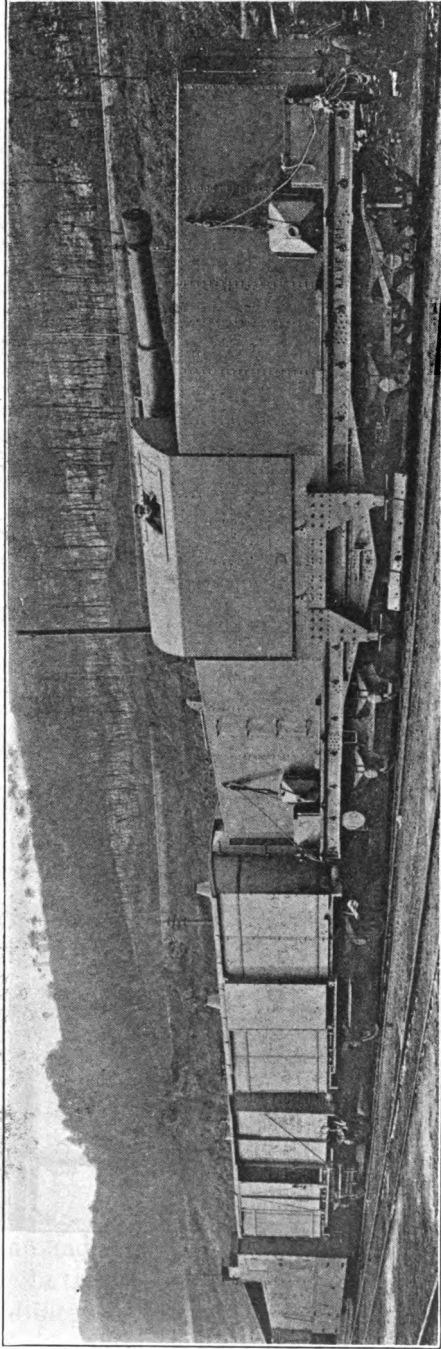

1944 ARMORED CAR TRAIN MADE UP IN TRAVELING FORMATION.

PLATE 27

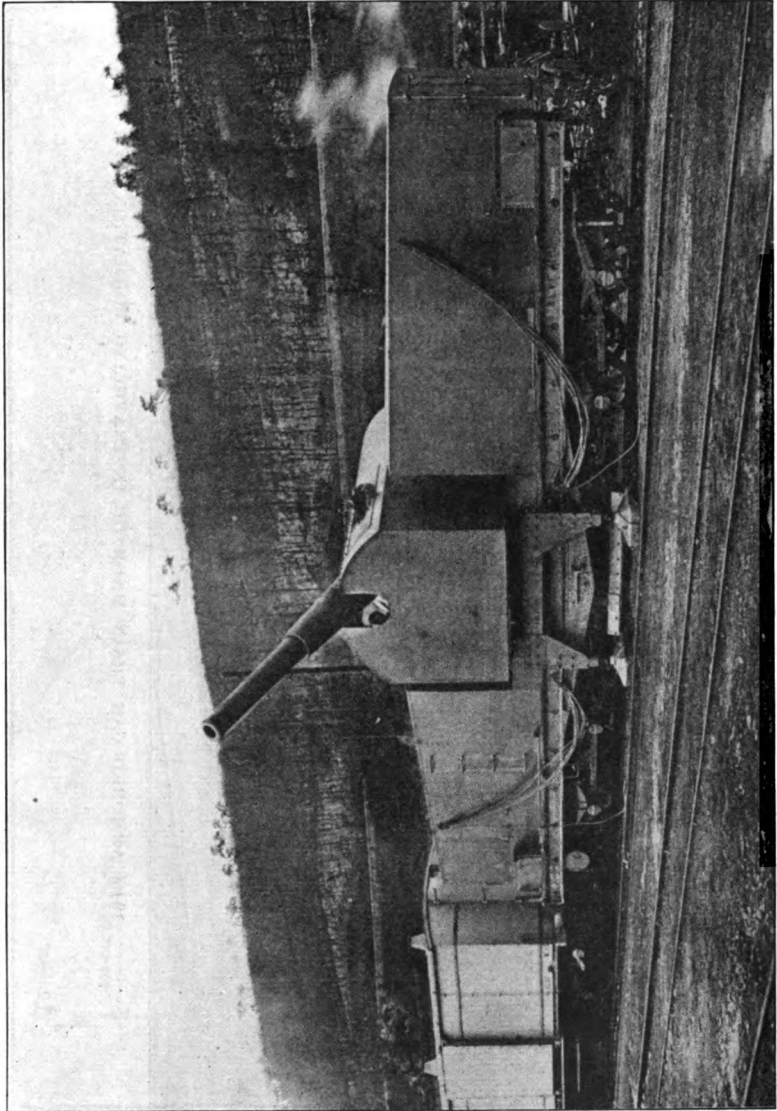

TOP CARRIAGE IN POSITION FOR CROSS-TRACK FIRING.

40. *Gun carriage.*—The gun carriage is a coast defense type and of model of 1886. It includes the cast base plate, racer with two side frames and transoms, and the various mechanisms above described. The rotating portion of the carriage carries a cab or turret of sheet steel for the protection of the personnel.

41. *Railway car body.*—The railway car body is merely a simple steel frame flat car. It is provided with a sheet-steel housing or passage at each end extending between the gun turret and the end of the car.

42. *Anchorage.*—The anchorage arrangements include two metallic stringers which can be lowered onto the rails by jack screws, four exterior jack screws placed near the ends of the stringers and outside of them, which can be brought to bear on footplates set on the roadbed, and four rail clamps situated at the ends of the stringers, which grasp the rail and hold the mount down. It is understood that the mount is apt to slip somewhat when fired along the track, but the anchorage appears to have been reasonably satisfactory.

43. *Ammunition supply system.*—This mount is used with an ammunition car having an end door, Plate 26. A trough or slide is pro-

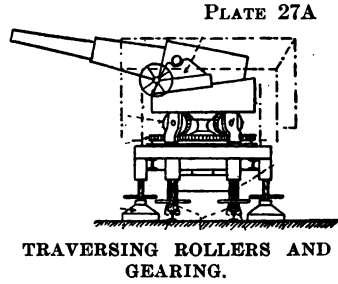
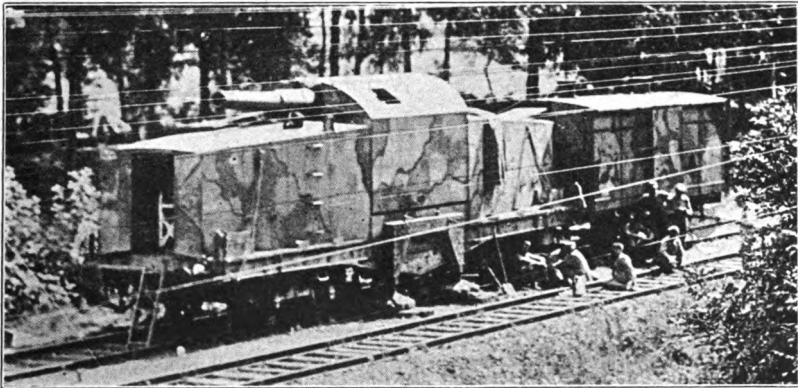

PLATE 28



GUN AND MUNITION CARS IN PLACE AND ANCHORED FOR FIRING.

vided through the housing at the end of the mount, with extensions which can be run in under the trolley hoist in the ammunition car and up through a hole in the back of the turret to the breech of the gun; the shot is lowered into this tray, pushed along, then rammed up into the gun, which loads at a considerable elevation. The turret, of course, must be brought to zero azimuth for loading.

44. *Difficulties involved in the service.*—It is not known why this mount was so carefully armored. Presumably the armor was later learned to be of little service. At any rate its presence would seem to hamper considerably the operation of maneuvering and loading the piece. It would seem also that the anchorage scheme might easily give trouble, or at least that frequent readjustment would be necessary.

200-MILLIMETER HOWITZER.

45. This type of mount is one which was constructed by the Schneider Co. for the coast defense of Peru in 1910. The mounts

PLATE 29

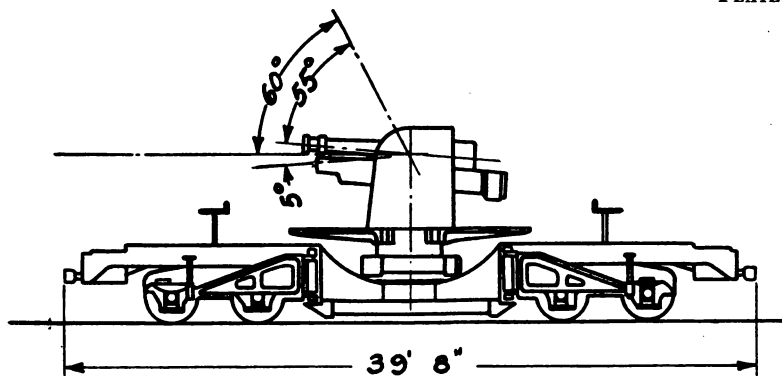

Total Weight	84,330 Lbs.	Traverse	360°
Weight Per Foot Run		Weight of Projectile	220.5 Lbs.
Over Bumpers	2150	Weight of Powder	29 Lbs.
Over Base	8540	Initial Velocity	13,95 Ft. Per. Sec.
Weight of the Gun	8160	Range Maximum	12,033 Yds.
Elevation	-5 to 60°		

200-MM. 15 CAL. HOW. (SCHNEIDER) ARMORED MT. ON DROP CENTER CAR WITH OUTRIGGERS.

were not delivered and so were available for the French Government at the beginning of the war. The design follows very closely the early one of General Peigne and embodies a seacoast type carriage with all round traverse and cradle recoil, mounted on a drop-frame flat car and the same sort of anchorage as the early 155-millimeter howitzer—track platform, side arm struts, and rail clamps. The mount is shown on Plates 29–34.

46. *Gun.*—The howitzer, 15 calibers in length, is composed of a steel tube reinforced at the breech with a sleeve. A clip ring near the muzzle and notches in the breech sleeve fasten it to the sleigh. The breech mechanism is of the eccentric screw, interrupted thread

PLATE 30

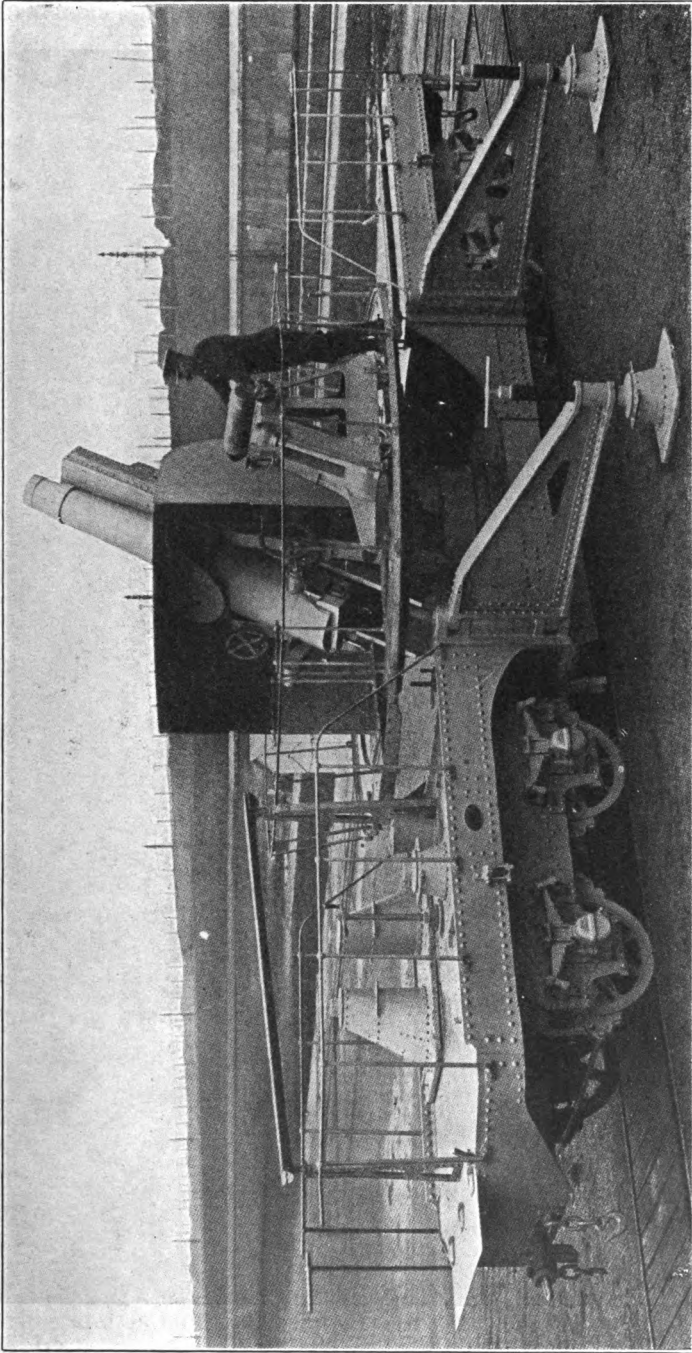

ANCHORAGE ARRANGEMENT AND SHELL TRUCK OF THE 200-MM. HOW. NOTE THE HIGH OUTRIGGER FLOATS ON REAR FLOOR OF CAR FOR USE WHEN SCREW RUN-NUT IS INSUFFICIENT DUE TO ELEVATION OF TRACK.

PLATE 31

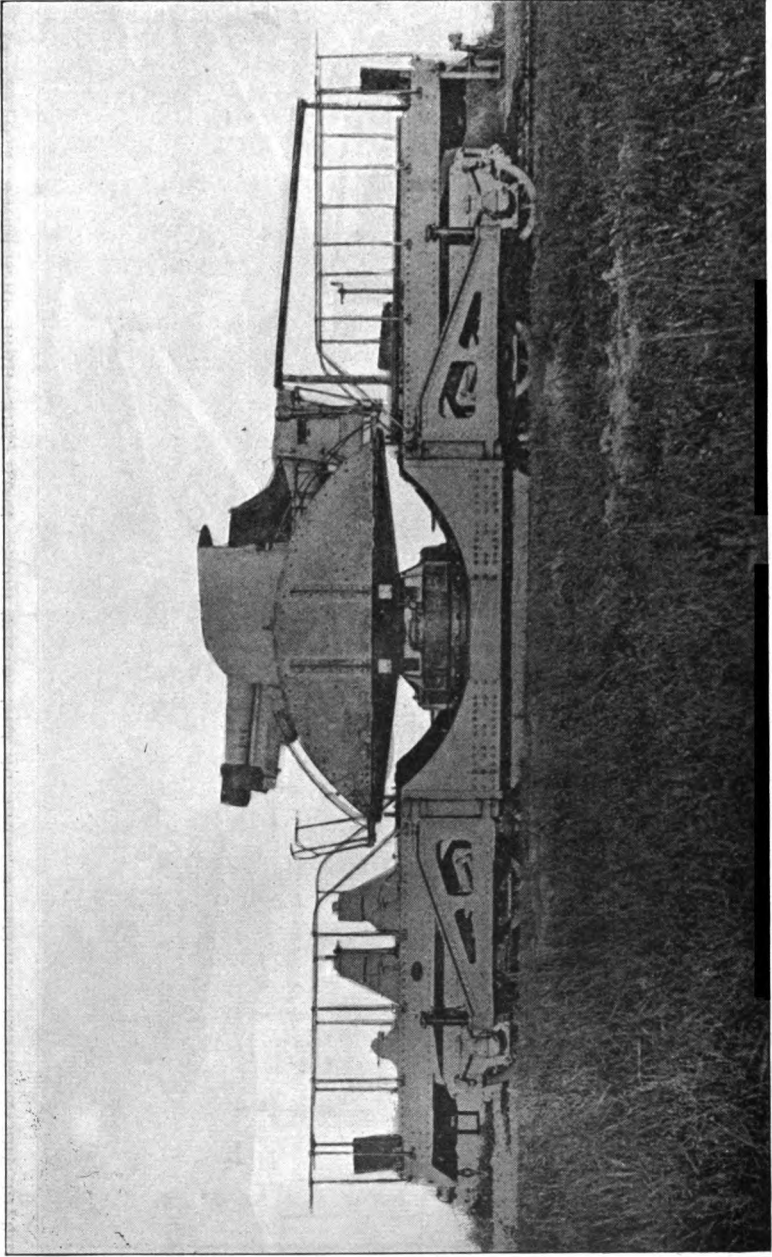

ANOTHER VIEW OF 200-MM. HOWITZER IN TRAVELING POSITION.

type, and is operated by a single motion of the lever. Safety devices are provided against prematures and hang fires. The firing mechanism is of the percussion type.

47. *Recoil mechanism.*—The recoil mechanism comprises a hydro-pneumatic cradle of the same type as is used on heavy Schneider field guns. The recoil and recuperator cylinders are rigidly attached to the howitzer, their pistons being attached to the front end of the cradle. The cradle itself is of sheet steel, with a U section. The howitzer slides on top of it and the recoil and recuperator cylinders fit into the hollow of the U and the whole is swung in the carriage by trunnions at the center.

48. *Elevating mechanism.*—The elevating mechanism, as with the 194-millimeter howitzers, is in duplicate, a slow mechanism for adjustment and a rapid one for loading. The main mechanism con-

PLATE 31A

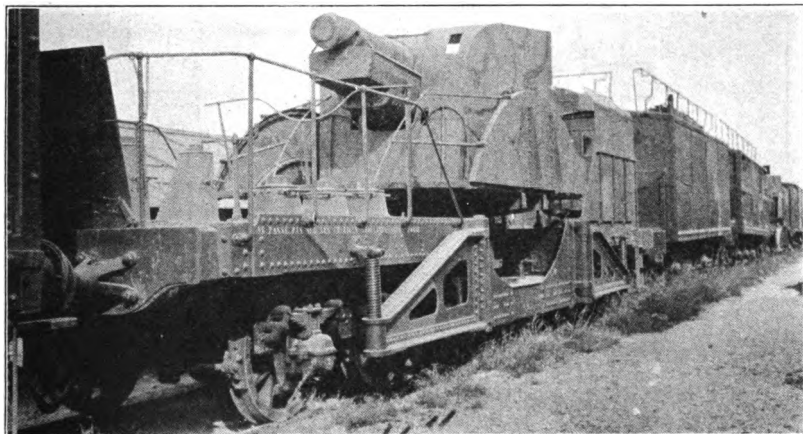

200-MM. HOWITZER CAR EN ROUTE IN TRAIN.

sists of a rack, pinion, worm wheel, and worm and bevel gears leading to a handwheel (0.16 meter radius). One turn of the handwheel moves the gun 0.77 degrees in elevation. The quick loading mechanism consists merely of a rack attached to the cradle and a pinion and handwheel (radius 0.20 meter). One turn of the handwheel moves the gun nearly 13 degrees in elevation. Antifriction roller bearings, spring supported, serve to reduce the trunnion friction. The springs, of course, give under firing conditions and the heavy shock is transferred to the main trunnion bearings.

49. *Traversing mechanism.*—A circular rack is attached to the base ring and is engaged by a pinion carried on a shaft from the racer. This shaft is connected through a worm and worm wheel and two bevels to a handwheel (radius 0.16 meter). No slip friction device was noted in this mechanism.

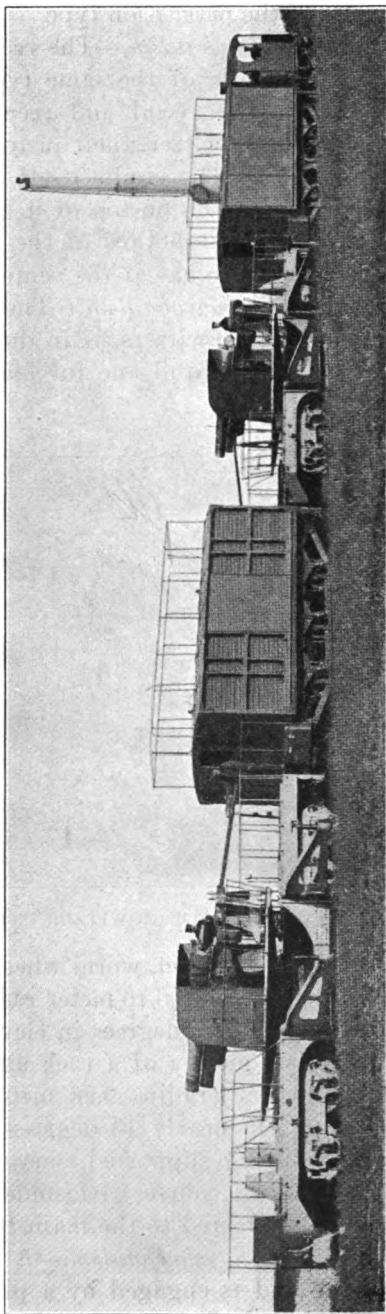
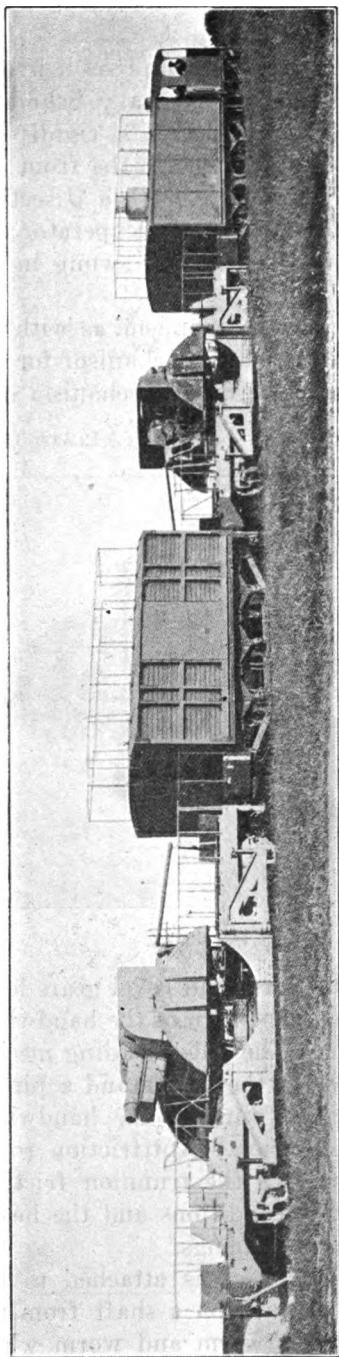

200-MM. 15 CAL. HOWITZER BATTERY TRAIN EN ROUTE (UPPER), AND WITH GUN CARS ANCHORED FOR FIRE (LOWER).

50. *Gun carriage.*—The above mechanisms are mounted on side frames and a racer made in a single casting. This rests on a base

PLATE 33

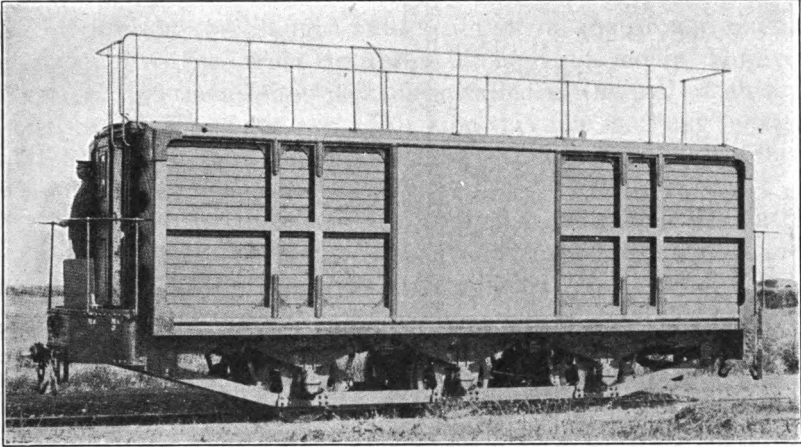

OUTSIDE AND INTERIOR VIEWS OF AMMUNITION CAR OF THE 200-MM. HOW. RAILWAY TRAIN.



ring through traversing rollers and is pivoted by a center pintle. A shield of sheet steel and a circular operating platform, with track for the shot truck, are also carried by this racer.

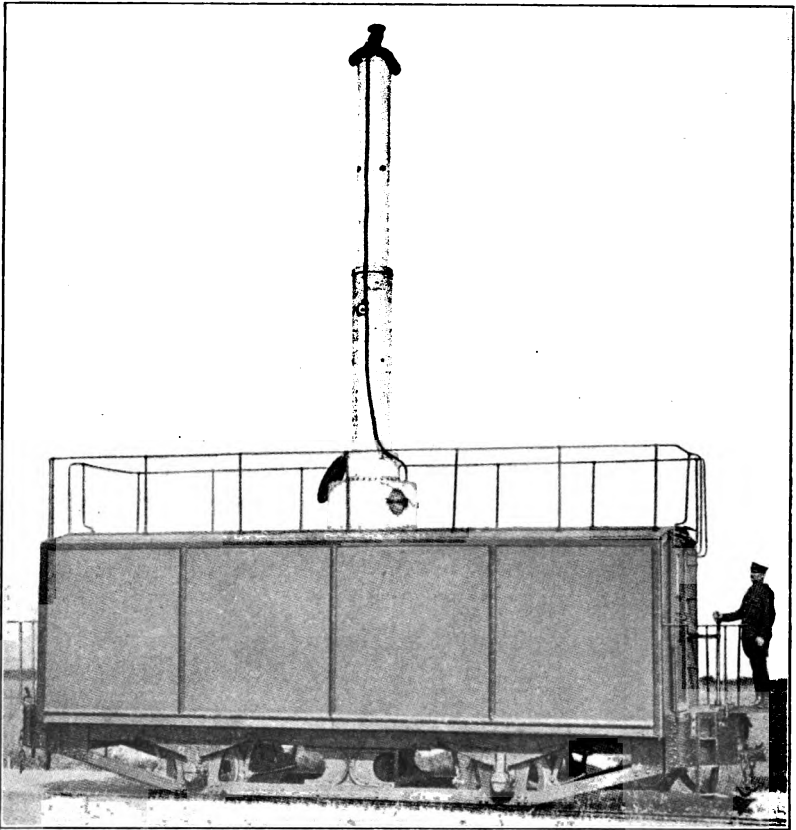

THIS CAR, ALSO A UNIT OF THE 200-MM. HOWITZER TRAIN, IS A COMBINATION PERSONNEL CAB AND OBSERVATORY.

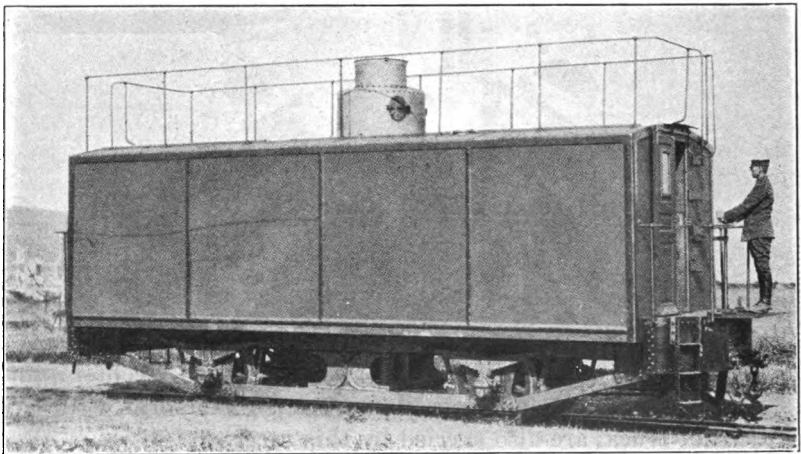

51. *Anchorage.*—The anchorage arrangement, Plate 30, is quite similar to that employed on the 194-millimeter gun mount, No. 11.* It includes two longitudinal stringers, which may be screwed down upon the rails, four rail clamps by which the car may be tied down to the track, and four exterior jacks by which part of the weight and shock of fire may be brought onto floats set on the ground outside the track. It differs from the 194-millimeter gun mount, however, in that each of these latter jacks is installed at the end of an arm pivoted to the side of the car. In action this arm is swung out and the jack screwed down upon the float. In traveling it is folded against the side of the car.

52. *Trucks.*—The trucks are two in number, with four 0.90-meter wheels each. The side frames are of structural steel, and outside journals and semielliptic springs are employed.

53. *Ammunition supply system.*—The same system of “gouttieres” or troughs is employed as with the 194-millimeter gun for transferring ammunition from the car to the gun. A shot truck is mounted on a circular track carried by the racer, however, rendering it unnecessary to return the gun into line with the track for every loading. The loading angle is plus 5 degrees.

54. *Merits.*—This mount would appear to combine all the desirable qualities of the various mounts discussed above. It is, however, the least powerful of all mounts discussed and it was developed in peace time, so that all desired advantages should have been realized.

240-MILLIMETER HOWITZER, MODEL 1876.

55. This mount, Plate 35, is an improvisation and is made up in general in the same way as the 194.4-millimeter howitzer mount, Model 1917, No. 6. The howitzer has a cast-iron body, reinforced

PLATE 35

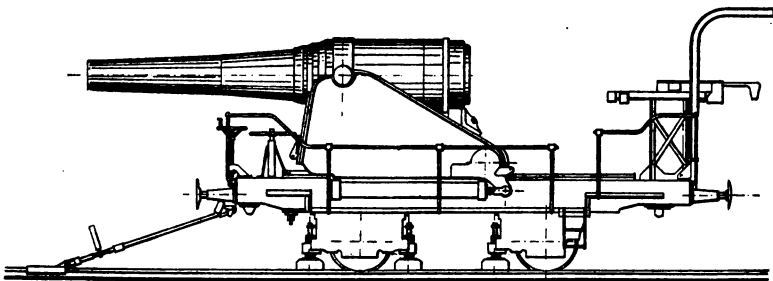

240-MM. HOWITZER MODEL OF 1876 ON TWO AXLE CAR.

with a steel liner and steel hoops at the breech end, and is 20 calibers in length. All of the characteristics of interest of the various mechanisms have already been described in detail.

* See explanation of numbers at head of table of contents.

240-MILLIMETER HOWITZER, MODEL 1876, ON CARRIAGE MODEL 1917.

56. This mount, Plate 36, is in general similar to the preceding. It has three axles instead of two, however, and the three jacking beams are suspended between the trucks instead of under the truck bodies or frames. The howitzer is of the same model, hence the mount perhaps represents an improvement over the previous design. It will be observed, likewise, that there is an ammunition

PLATE 36

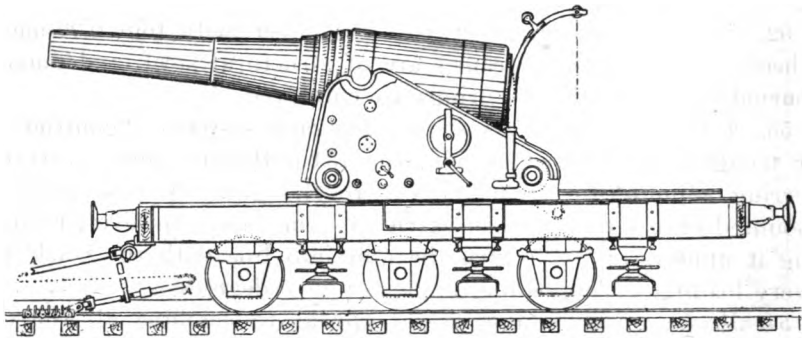

240-MM. HOWITZER MODEL OF 1876 ON CARRIAGE MODEL 1917.

hoist attached to the side of the gun carriage, whereas on the preceding mount an ammunition table is provided at the rear end of the car body.

240-MILLIMETER HOWITZER, MODEL 1876, ON G. P. C. MOUNT.

57. This mount, Plates 37-38, represents the highest development of this type of design during the war. A large number of them were in the hands of American Railway Artillery Reserve and were used in the St. Mihiel offensive and from that time on in various parts of the line. They seem crude, of course, but under the circumstances they proved worth while, since they could be served rather rapidly and had the fair range of 13 kilometers.

58. *Recoil mechanism.*—The recoil mechanism of this mount is closely similar to that of the 194-millimeter howitzer mount, Model 1917. It is of the top-carriage type with spring counterrecoil. The two hydraulic cylinders are located just below the carriage rails and outside the side sills of the car. They are about 9 inches outside diameter and 6 feet long, with piston rods about 2.5 inches in diameter. The two spring recuperators are detachable and when not in use are carried on the side of the car. Each recuperator is attached

by a bolt to the forward end of the car body and by another bolt through the piston rod to a hook on the forward end of the gun carriage. This latter bolt is then drawn back by a nut and the recuperator can not rise out of the hooks. For traveling, turnbuckles with hooked rods in each end are substituted for the spring recuperator and the carriage is screwed up firmly against the stops. Details of the recoil and counterrecoil mechanism are shown on Plate 14.

59. *Elevating mechanism.*—The elevating mechanism is the same as for the 194.4-millimeter howitzer mount, No. 5.

60. *Traversing mechanism.*—It is not possible to traverse the gun on its carriage or the top carriage on the car body. The mount may be traversed either by moving it on a curved track or by placing it

PLATE 37

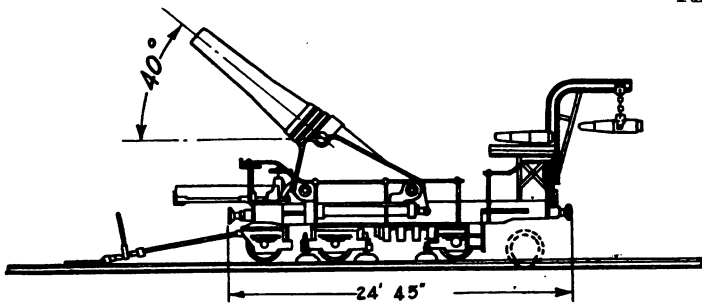

Total Weight When Firing	89,330*	Elevation	+ 5° To + 40°
" " Transported on Road	95,930	Traverse on Curved Track	
" " Transported on R.R.	90,400	Weight of Projectile	355*
Weight Per Foot Run		Weight of Powder	29*
Over Bumpers	3710*	Initial Velocity	476 Ft. Per Sec.
Over Wheel Base	6700*	Range Maximum	14,220 Yds
Weight of the Gun	35,830*		

240-MM. HOWITZER MODEL 1878, ON G. P. C. MOUNT.

on a firing platform of the type described under mount No. 6, on which platform a traverse of 60 degrees may be secured.

61. *Gun carriage.*—The top carriage is composed of two cast-steel, triangular side frames, 1.25 inches thick with 3-inch flanges, joined by front and rear transoms, Plate 38. Steel trunnion bearings are riveted to these frames, but no trunnion caps are provided. The top carriage is supported on four wheels about 15 inches in diameter by 6 inches thick and mounted on 8-inch axles.

62. *Railway car body.*—The body of this car is most simple in design. It is composed of two 24-inch I beams on top of which are located the rails on which the top carriage slides in recoil. These beams are connected by transoms and carried on three structural steel boxes in which the wheels and axles are mounted. Provision is made for removing the front wheels and axles and supporting both

the front and rear ends on road trucks so as to convert the whole into a tractor-drawn mount. The road wheels are shown in dotted lines on Plate 37. A similar arrangement for road travel is shown for the 240-millimeter gun, Model 1903, on Plate 53.

PLATE 38

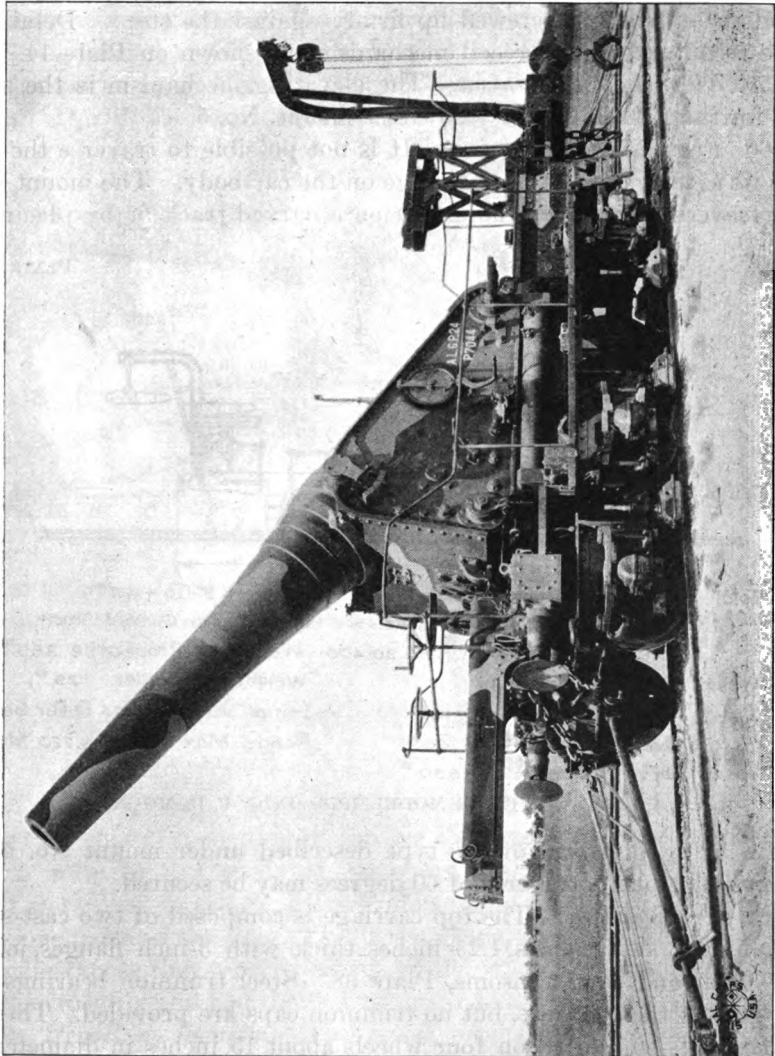

WITH HOLD FAST AND TRUCK JACKS IN PLACE.

63. *Anchorage.*—The system of anchorage is exactly the same as that of the 194.4-millimeter mount, No. 5.

64. *Trucks.*—The car body really constitutes a single 6-wheel truck. The center axle is situated unsymmetrically, forward of the mid-point between the other two. The wheels are 0.80 meter in diameter and the car is supported on them through semielliptic springs.

240-MILLIMETER GUN, MODEL 1893, 1896, ON ST. CHAMOND MOUNT.

65. This mount, Plates 39 and 40, consists of a coast-defense gun and its top-carriage recoil, all round traverse carriage mounted on a specially constructed drop-frame steel railway car. It has been familiarly known as the "Colonies" mount and was made up early in the war for the 305-millimeter gun.

66. *Gun.*—The gun is a steel tube 40 calibers long. It is provided with trunnions 12 inches in diameter by 8 inches long, approximately, mounted by means of a trunnion band about 4 by 24 inches. Provision is made on the side of the gun carriage for adjusting the center line of the trunnions. The breech mechanism is the Manz screw type with interrupted threads and is operated by a handwheel. Obturation is secured through the use of an annular copper obturator.

PLATE 39

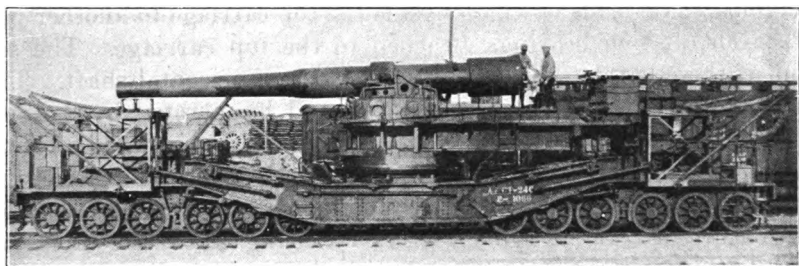

LEFT SIDE ELEVATION 240 GUN, MODEL 1893-1896. LOADING RIG SUPERSTRUCTURE KNOCKED DOWN FOR CLEARANCE WHEN TRAVELING.

67. *Recoil system.*—This mount, as mentioned above, has top-carriage recoil. Counterrecoil is by gravity. The gun is suspended in a heavy cast saddle, which in turn is supported on the rolling gun carriage. This recoils up rails rising toward the rear with an inclination of 4 degrees. These rails are carried on a racer in which the recoil cylinders are installed. These cylinders are two in number and are about 15 inches in diameter. Each is attached inside the front of the racer at a point about 42 inches below the gun by means of a 6-inch pin, about which the cylinder is free to revolve in a vertical plane. Each piston is similarly attached to the gun carriage in such a position that its axis is approximately parallel to the inclined rails. This form of attachment, however, makes the buffer self-aligning and more distinctly a separate mechanism than on any other mounts examined. On this account continual inquiries were made as to whether the design had ever been found defective. All of the officers who had handled artillery of this type were positive that no difficulties had ever been experienced with the buffers.

68. *Elevating mechanism.*—The gun is normally carried on very small radius auxiliary trunnions which rest in corresponding auxiliary bearings. These are supported at the center of a heavy lever, one end of which rests solidly on the top carriage, while the other is supported by adjustable Belleville springs. Under the shock of firing, the spring-supported end drops, letting the gun descend slightly and allowing the main trunnions to seat in their bearings, which are purposely left with a small clearance. This antifricition device greatly reduces the labor of moving the gun in elevation.

69. The gear train of the elevating mechanism is unusual in that the operating handwheel and some other parts do not recoil with the top carriage. The arrangement, which is as follows, can be traced out on Plate 40. An elevating rack with inside teeth is attached to the breech end of the gun by a 1 by 5 inch strap. This rack has a 2-inch face and meshes with an idler, which in turn meshes with a pinion. The shaft of this pinion is provided with a slip friction device and bevel gears. From this pair of gears a diagonal shaft leads down alongside the top carriage to another pair of bevels, also in bearings attached to the top carriage. The second of these bevels slides along a stationary horizontal shaft. This shaft is provided with a worm wheel and is operated by a worm, sprockets, and chain leading to a handwheel. Exact figures on the gearing are not available, but it appears that the gun is elevated between 1 and 1.5 degrees per turn of the handwheel. The elevation can be varied from 15 to 35 degrees for firing across the track, but parallel to it certain interferences with the car body limit the elevation to 29 degrees.

70. *Traversing mechanism.*—A traversing rack 6 inches wide, extending around the carriage, is bolted to the outside of the racer at its bottom. At the rear a pinion on a vertical shaft meshes with the rack. This shaft is carried in bearings fixed to the car body and a gear train leads to two cranks located on each side of the car body just at the forward end of the "drop" portion and clearly seen in the photograph, Plate 40. Three or four men are required to operate this. The carriage can be traversed 360 degrees and is provided with a lock for fixing it in the position of zero traverse for loading or traveling.

71. *Gun carriage.*—The gun carriage is the 305-millimeter sea-coast carriage, Model 1899, modified to adapt it to the smaller gun. The rolling top carriage is made up of two main parts. The one is the saddle in which the gun is supported, which in turn is fixed on the heavier frame of the rolling carriage. The body of the main part is a two-piece casting bolted together in the center. The carriage rolls on 10 rollers, 5 on each side, 15 inches in diameter, with

PLATE 40

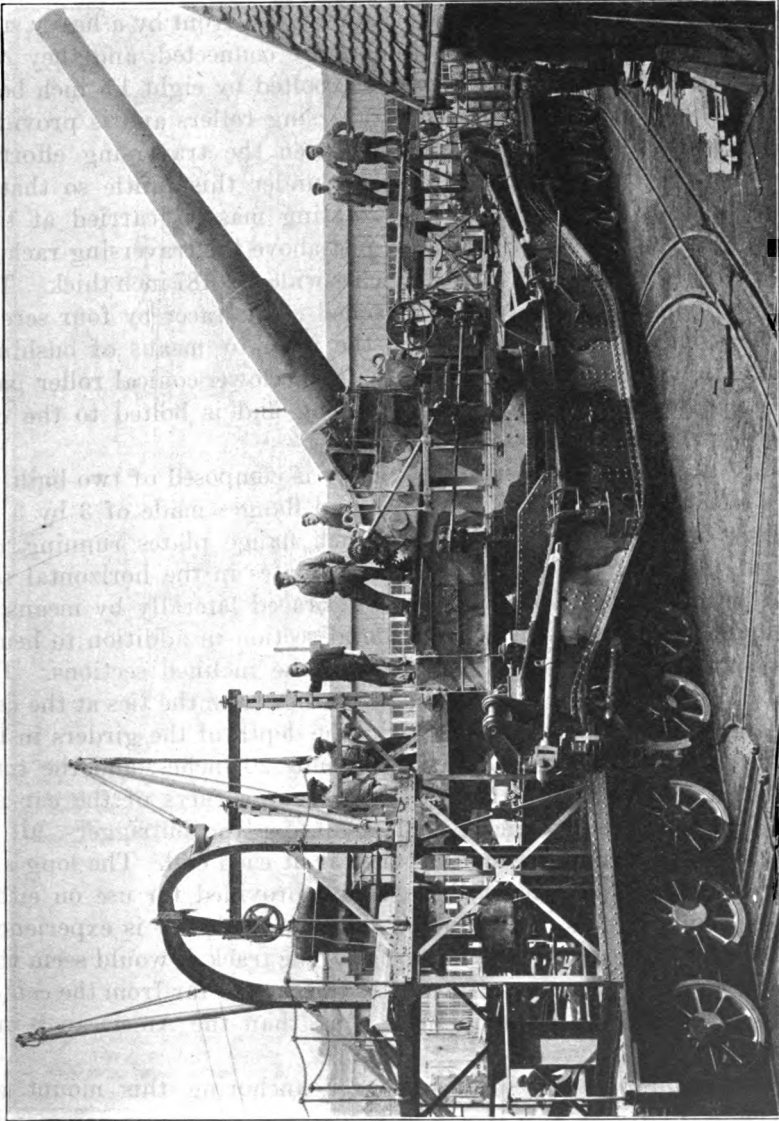

ST. CHAMOND MOUNT WITH 240-MM. GUN, MODEL 1893-1896.

5-inch shafts. The rails are 8 inches wide, and, as before mentioned, they are inclined at 4 degrees. On the front of the top carriage are two buffers, about 4 inches in diameter, which project about 3 inches and meet corresponding buffers on the main carriage and serve to cushion counterrecoil. The side frames of the main carriage are cast-steel beams of I section; these are connected in front by a heavy steel transom to which the recoil cylinders are connected, and they rest in turn on the racer to which they are bolted by eight 1.5 inch bolts each. The racer rests on conical traversing rollers and is provided with a center pintle. In order to lessen the traversing effort a spring-supported bearing is arranged under this pintle so that a large part of the weight of the rotating mass is carried at this point. At the bottom of the racer, just above the traversing rack, is attached a brass azimuth ring 2.5 inches wide by .187 inch thick. The ring is in eight sections, and is attached to the racer by four screws per section. It is separated from the racer by means of bushings around the screws. The base plate, with the lower conical roller path on its upper surface, is a single casting and is bolted to the car body by sixteen 3-inch bolts.

72. *Railway car body.*—The car body is composed of two built-up side girders, having .625 inch webs and flanges made of 3 by 3 by .5 inch angles and two .75 by 12 inch flange plates running the entire length of the girders and three plates in the horizontal section at the center. These girders are braced laterally by means of six built-up transoms in the horizontal section in addition to heavy transoms at the ends and laticing on the inclined sections. The bottom of the side girders is about 15 inches from the ties at the center and 4 feet 6 inches at the ends. The depth of the girders in the center is about 36 inches and at the ends 20 inches, and the total length about 40 feet. At each of the four corners of the car are attached heavy cast brackets, Plate 40, for the outriggers, all of which can be seen at the sides of the car at each end. The long and short outriggers shown on Plate 41 are provided for use on either level ground or fills. Inasmuch as extreme difficulty is experienced in holding this car when fired normal to the track, it would seem that the outrigger brackets are attached to the car too far from the center. The car is inclined to whip even more than the American 8-inch mount.

73. *Anchorage.*—The provisions for anchoring this mount are shown on Plates 41–47. It was learned from the battery commander that the original provision for anchoring the car simply by means of outriggers and a rather simple type of firing platform was unsatisfactory. As a consequence the provision for bracing the car by means of five screws and hooks, Plate 42, and additional beams on each side have just been added. The guns have not been in action

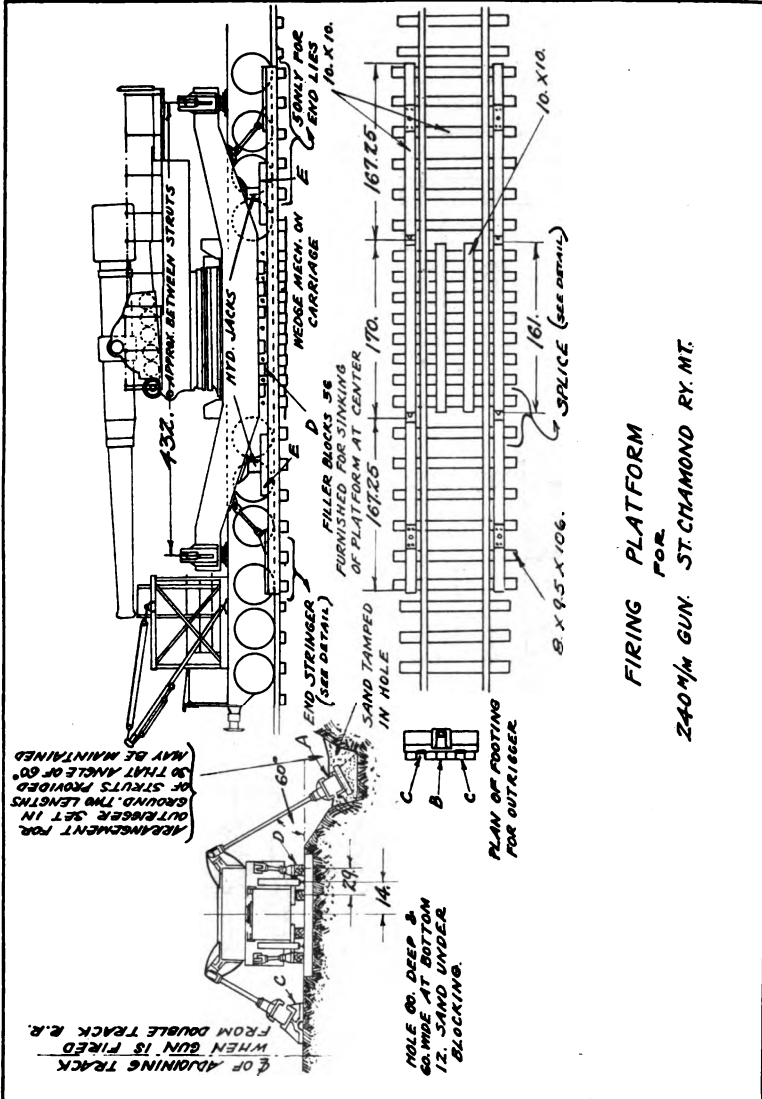

FIRING PLATFORM
 FOR
 240mm GUN. ST. CHAMOND RY. MT.

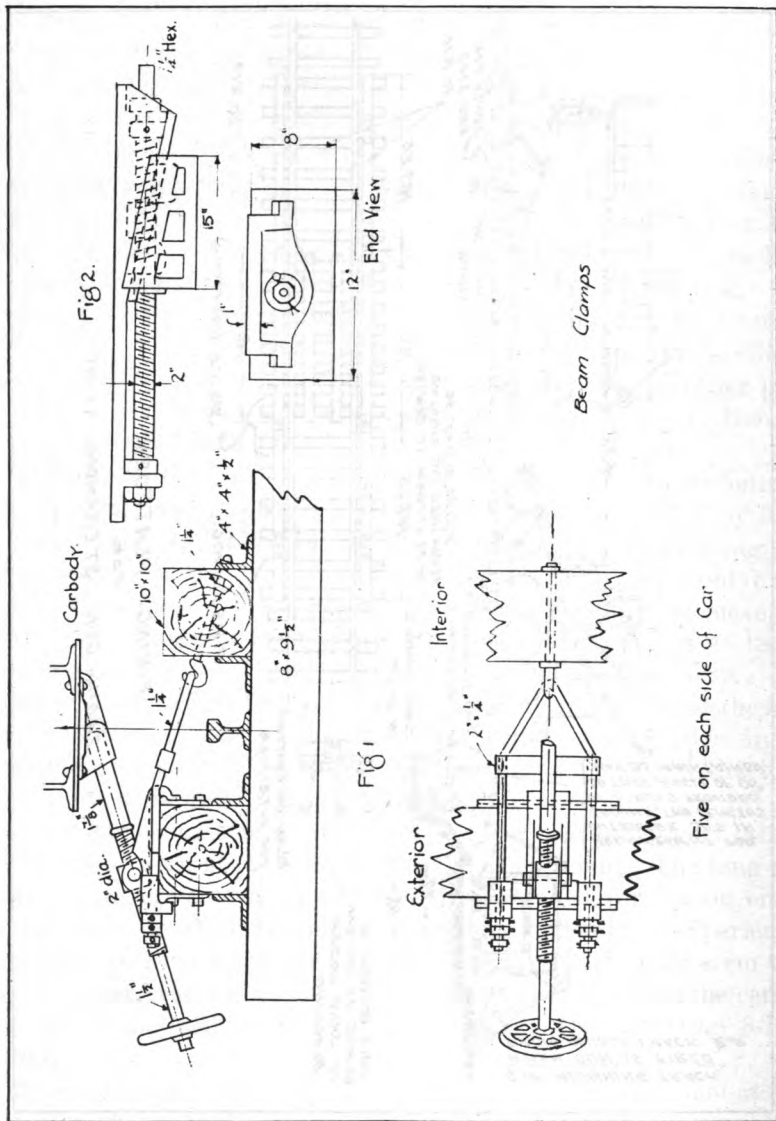

240-MM. GUN, MODEL 1893-1896, ARRANGEMENT FOR ANCHORING WHEN FIRING CROSS TRACKS.

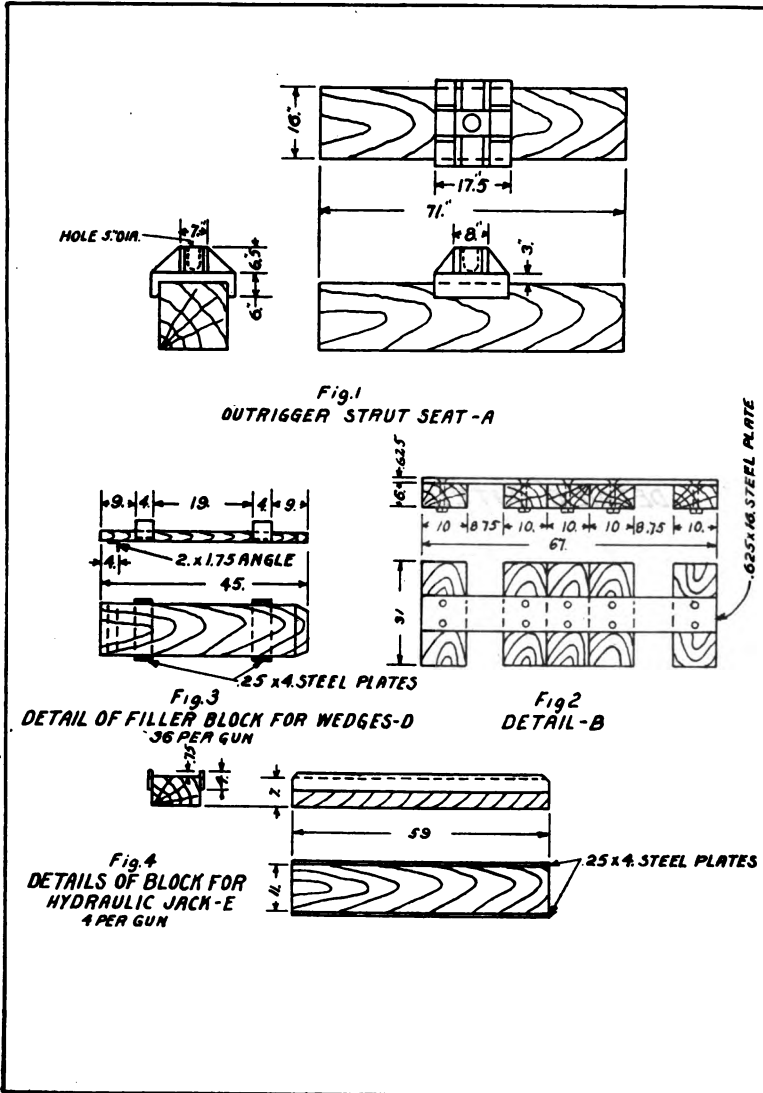

OUTRIGGER FLOAT DETAILS OF 240-MM. GUN, MODEL 1893-1896.
452-22-5

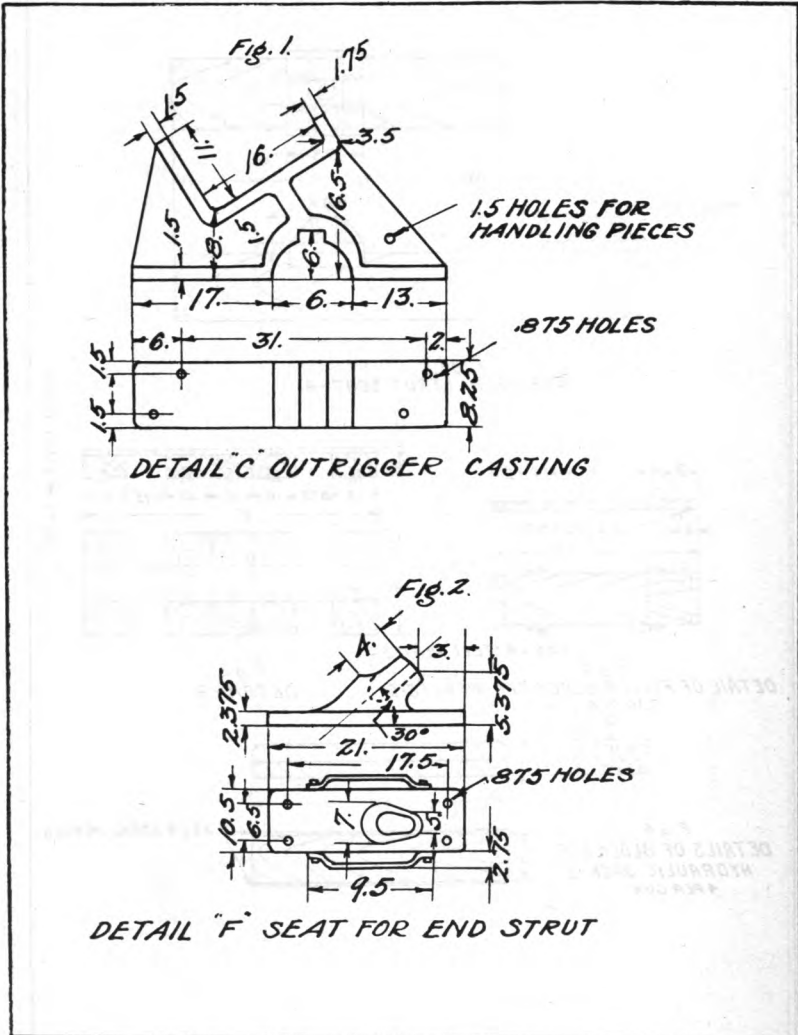

OUTRIGGER FLOAT DETAILS OF 240-MM. GUN, MODEL 1893-1896.

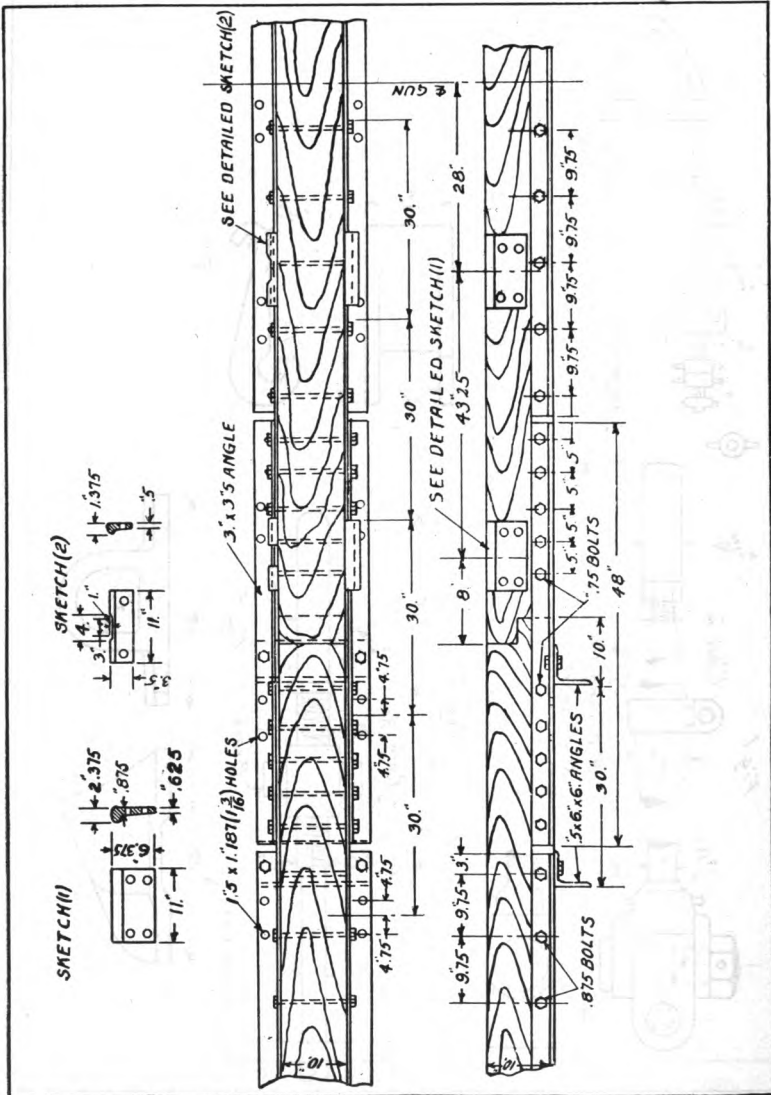

240-MM. GUN, MODEL 1893-1896, TRACK BEAM DETAILS FOR ANCHORING CAR.

since the extra braces have been provided, hence no data is available with reference to their practicability.

74. On Plate 41 it will be noted that outriggers of two lengths are provided. These outriggers are intended to be attached to the same brackets and are used according to the nature of the ground at the firing position. To avoid unnecessary excavation the short strut is used for level ground and the long one for fills. There is a serious question as to whether the base or float provided for this mount is as effective as that provided for the American 8-inch. On Plate 43, Figure 1, is shown the beam with its socket, which is used with two of the cast blocks, Figure 1, Plate 44, as a base for each strut. When the gun is fired from a double-track railway the steel block is so made as to set over the near rail of the adjoining track, Plate 41.

PLATE 47

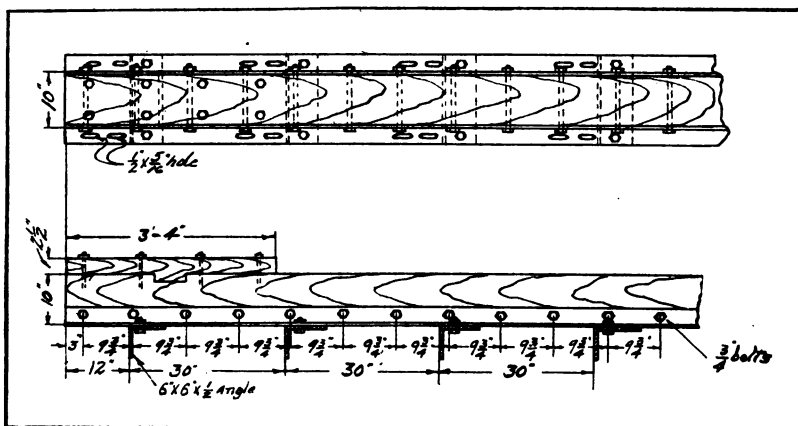

240-MM. GUN, MODEL 1893-1896, TRACK BEAM DETAIL, FOR ANCHORING CAR.

When the base is placed on the ground the cast blocks rest on the platform, Figure 2, Plate 43, which in turn rests on sand or crushed stone. Provision is made on the strut, Figure 1, Plate 45, for taking up the play as the base settles into the ground.

75. The firing platform provided for carrying the weight of the car and bracing it against motion in the direction of the track requires 12 hours for installation. On Plates 42, 46, and 47 are shown the stringers that are placed on the ties between and outside of the rails. Figure 3, Plate 43, is a detail of the filler block used under the wedges, Figure 2, Plate 42; see "D," Plate 41. On Plate 45, Figures 2, 3, 4, and 5, are given the details of the bracing mechanism of which an assembly is given on Plate 42, Figure 1. This is the additional provision that was last made for bracing the car. No data is available on the success of its use.

76. *Trucks.*—These trucks are designed especially for the mount, Plates 39 and 40. The body is made up of two side plates 1.25 inches thick with suitable transoms; the brakes apply only to the center four wheels. Identical ammunition supply platforms and elevators are built on both trucks.

77. *Ammunition supply system.*—No special ammunition cars seem to be provided for this mount; both powder and shell are carried in standard box cars. On the end of the loading platform, Plate 39, is a steel ammunition cabinet divided in twenty-one 10 by 10 by 30 inch sections, open in front. The sections in the central vertical tier are open at the back as well as at the front. On the top of the cabinet six shallow troughs are provided, in addition to the central receiving trough, for the storage of projectiles. An additional shallow trough about 9 feet long is provided to reach from the central top trough to the breech of the gun. The projectile is slid forward on this trough and rammed by hand. The gun must be returned to minus 1 degree for loading. On each truck will be seen the framework into which the elevator is built, at the top of which is a platform for the men who transfer the ammunition from the elevator into the cabinet. The elevator contains four trays, Plate 40, the top tray for projectiles and the bottom three trays for powder. In line with these trays when the elevator is down are four other trays, built on the trucks; the top tray of these four runs to the back of the truck where the projectile may be placed on it. The bottom three trays are short and the bags of powder are lifted up from the ground by hand and placed on them. When the elevator is down the projectile and three bags of powder are slid forward on the elevator trays. The elevator is operated by means of a simple windlass, the rope running up and over a pulley at the top of the frame. When the elevator is up a latch holds it in place. When the projectile tray is in line with the top tray of the cabinet the projectile and three bags of powder are slid forward onto and into the cabinet by the men standing on the rear platform.

78. *Maintenance.*—To date the French have not found the problem of maintenance on this mount serious, although the mount can not be considered satisfactorily successful because of the difficulty that they have experienced in anchoring it properly. As yet very little shop-work or field repairs have been necessary on the mount as originally provided. No parts have been broken or damaged except accidentally.

79. *Difficulties involved in the service.*—The only difficulties that the battery commanders handling these mounts report are in connection with the anchorage system. The system is unsatisfactory. To date it has not been possible to use the gun satisfactorily at a con-

siderable angle to the track. Inasmuch as it is almost always desired to use a mount of this type at short notice, 12 hours is too much time for the installation of the firing platform.

240-MILLIMETER GUN, MODEL 1884, WITHOUT TRAVERSE.

80. This mount, Plate 48, is again one of the familiar improvizations made up to accommodate a seacoast gun and its carriage. It has a few features that are unusual. On the front end a windlass is mounted for pulling the mount back into position after firing. There

PLATE 48

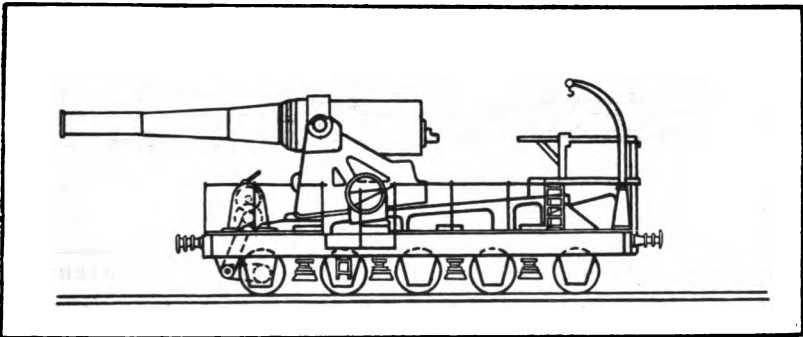

240-MM. GUN, MODEL OF 1884.

are four friction firing beams mounted in this case between the axles instead of in conjunction with the trucks as in several other mounts.

240-MILLIMETER GUN, MODEL 1884, WITH TRAVERSE.

81. This improvization, Plate 23, is identical with No. 9 for the 194.4-millimeter gun, Model 1870, 1893.

240-MILLIMETER GUN, MODEL 1870, 1884, 1887.

82. This mount, Plate 49, is of the same general type as that for the 194-millimeter gun, Model 1870, 1893, No. 11, being made up of an old seacoast gun and mount, with top carriage recoil and all-round traverse, mounted on a two-truck car with jacks, struts, etc.

83. *Gun.*—The body of the gun is of cast iron, and it is reinforced with a row of hoops. It contains inside a steel tube also reinforced by a row of hoops. The breech mechanism is of the marine type, similar to that of the 19-centimeter gun, Model 1870, 1893. The firing mechanism is of the percussion type.

84. *Elevating mechanism.*—The elevating mechanism permits of elevation from minus 3 to plus 30 degrees. The mechanism is mounted entirely in and constitutes a part of the rolling top-carriage.

85. *Anchorage.*—The anchorage arrangements include four metallic stringers, which can be lowered onto the rails by jackscrews,

PLATE 49

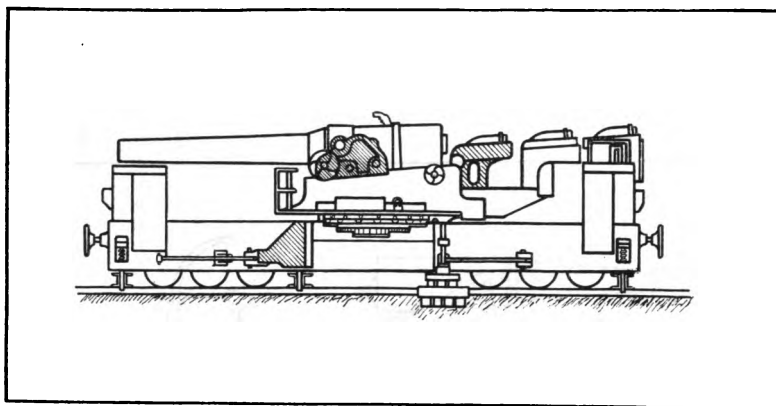

240-MM. GUN, MODEL 1870, 1884, 1887, ANCHORED FOR 360° TRAVERSE.

and four exterior struts, which swing out from the sides of the car at points near the ends of the two center stringers and are provided with jacks at the ends. For firing, the stringers are first lowered to the rails and the mount is jacked up on them slightly. The rail clamps, which are provided on the underside of the stringers, are next tightened against the rails. The exterior struts are then swung

PLATE 50

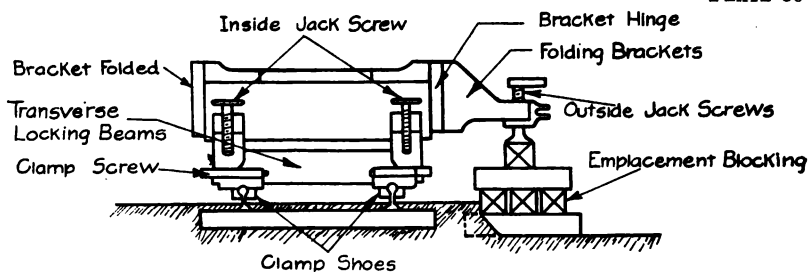

ANCHORAGE FOR 240-MM. GUN, MODEL 1870, 1884, 1887.

out and braced in place, and the jacks at their ends are screwed down to a bearing on floats placed on the ground beneath them, Plate 50.

86. *Ammunition supply system.*—The mount is provided with an ammunition rack at each end. Another rack, capable of holding several shells, is mounted at the rear end of the carriage and turns with it. A shot track serves to convey the shells from this rack to the gun.

240-MILLIMETER GUN, MODEL OF 1903.

87. This mount, Plates 51-54, comprises a double recoil carriage carried on a car arranged for standard gauge, narrow gauge, and road transportation. In operation it is anchored to a self-contained ground platform.

88. *Gun.*—The gun is a steel tube provided with a breech mechanism of the revolving block type, known in France as “System Canet.” The breech block is a hemispherical sector revolving about an axis through its own center and through and perpendicular to the center line of the gun. The sides are parallel surfaces perpendicular to this axis, and are provided with circular grooves which

PLATE 51

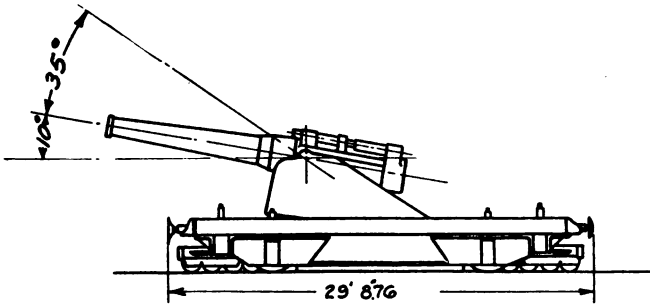

Total Weight	105,770*	Traverse on Curved Track	
Weight Per Foot of Length		Weight of Projectile	352*
" Over Bumpers	3,560*	" Charge	53.5*
" Over Foundation	7,710*	Initial Velocity	612. Ft. Per. Sec.
Weight of the Gun	39,200*	Range Maximum	17,500 Yds.
Elevation	+10° to +35°		

240-MM. GUN, MODEL OF 1903, SHOWING STANDARD AND NARROW GAUGE TRUCKS.

slide around in similar grooves in the gun breech. The entire block is pierced by a hole in the center of the diameter of the powder chamber. To open the breech the block is turned about its axis until this hole is in line with the bore of the gun. To close, the block is turned 90 degrees. The block is arranged to operate automatically and to eject the powder case. Semifixed ammunition is used. The firing mechanism is of the percussion type.

89. *Recoil mechanism.*—This carriage has a double recoil mechanism, a combination of cradle and top-carriage recoil. The cradle-recoil system is provided with pneumatic counterrecoil, and the recoil length is 0.62 meter. The top-carriage recoil system has gravity counterrecoil, and the length of recoil is 1 meter.

90. *Elevating mechanism.*—It is possible to elevate the gun to a maximum of 35 degrees. It is loaded at plus 10 degrees. The mech-

anism has a ratio of 1 degree of elevation per turn of the handwheel, and embodies an antifriction device to reduce the effort in elevating and depressing the gun.

91. *Traversing mechanism.*—This mount is provided with car body traverse. The car and trucks move on a base plate, allowing 7-degree traverse on each side of the center line. The base plate is arranged with a pintle in front and the car has two rollers behind.

92. *Railway car body.*—The railway car body is little more than a simple flat car built of structural steel. It is provided with a special hoist, a sort of shear leg derrick, Plates 53 and 54, by means of which the gun and cradle can be removed from the carriage and placed in another car for transport.

93. *Anchorage.*—As noted under traversing mechanism, this mount is provided with a base plate on which it is supported in firing. For traveling this is held to the car by four bolts. In placing the gun

PLATE 52

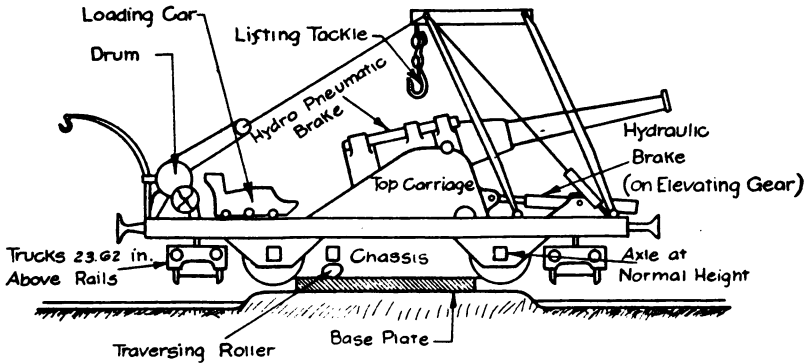

240-MM. GUN, MODEL OF 1903, EMPLACED FOR 14° TRAVERSE.

for action it is customary to run the mount to the nearest point on a standard-gauge track and to convey it to the firing position on narrow-gauge track or by road. This firing position consists of a flat top bank of well tamped earth, or of stone or timber, so arranged as to constitute a flat foundation with its upper surface 14 centimeters above the rail. The narrow-gauge track, which starts with a turntable between the standard-gauge rails and leads off at right angles, is laid through this platform with the foundation material taken out above the rails. On arrival at the foundation the mount is lowered so that its entire weight rests on the latter through the base plate. The base plate is prevented from slipping back on the foundation by means of two guys with turnbuckles which are attached to deadmen buried in front of the mount.

94. *Trucks.*—This mount is provided with both standard and narrow gauge trucks. The standard-gauge arrangement consists of two

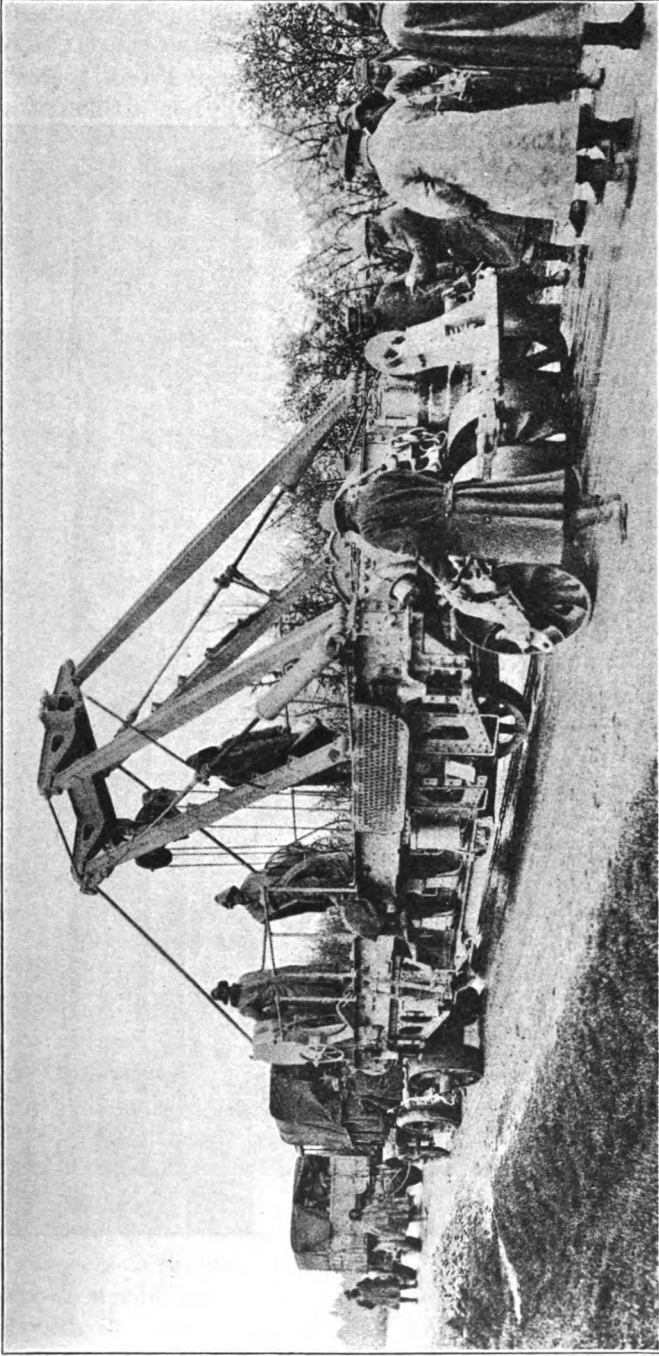

CAR FOR 240-MM. GUN MOUNT, MODEL 1908, INSTALLED WITH ROAD TRUCKS AND WITH MOUNT REMOVED.

PLATE 54

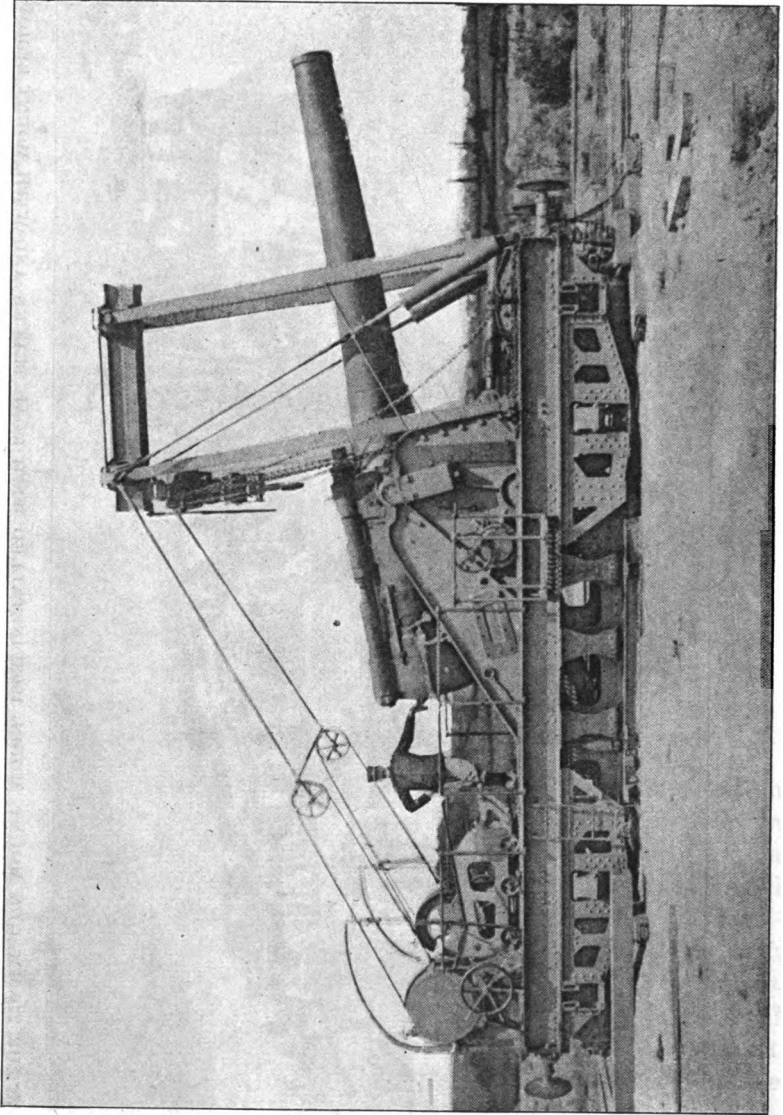

ANCHORED FOR FIRING.

axles which can be raised and lowered. The narrow-gauge arrangement consists of two independent narrow gauge trucks attached to each end of the car outside of the standard-gauge axles. These can also be raised and lowered. Jackscrews are provided on the car body, on which the weight can be carried during the transfer from one set of trucks to the other. Road wheels may be substituted for the narrow-gauge trucks and the mount may then be hauled directly over a highway.

95. *Ammunition supply system.*—The ammunition supply system consists of a jib crane, which lifts the shells from the ammunition car, and the shot truck in which they are deposited. This runs on rails from the rear of the mount up to the breech. The loading angle is plus 10 degrees, and an automatic rammer of the flexible-link type operated by two handwheels pushes the shell into the gun.

96. *Difficulties involved in the service.*—The most serious difficulties are those encountered in transferring the mount from the standard-gauge track to the firing position and the reverse. The gun can be operated at satisfactory speed when it is located in its firing position.

97. *Merits.*—The merits of this mount are doubtful. The schemes of attaching the narrow-gauge trucks permanently to the car and of lifting the standard-gauge axles out of the way, and the loading mechanism which permits the loading at considerable elevation are at least interesting.

274.4-MILLIMETER HOWITZER, MODEL 1870, 1881, AND 1870M.

98. This mount, Plate 55, which is a 1917 model, is another improvisation from a seacoast gun and carriage. It embodies a combination of top-carriage and sliding recoil. The carriage was called "Affut G. P. A. 1883" and is the same as that employed on the mount next described, No. 22.

99. *Gun.*—Two types of guns are mounted on this matériel. The model 1870M is a howitzer of 15 calibers length. It is made up of a cast-iron body, with a liner inside at the breech end and two rows of steel hoops shrunk on the outside at the breech end. The breech mechanism is of the interrupted screw type, operated by a lever attached directly to the breech block, as in the 194.4 howitzer, No. 5. The model 1870, 1881 is a howitzer of 25 calibers length, but similar in other respects to the gun above.

100. *Recoil mechanism.*—The top-carriage recoil on this mount is identical with that described in detail for the next mount, No. 22. The sliding recoil is similar to that on the large sliding mounts. For firing, a large part of the weight is transferred to the sleepers, which

rest on special rails and support the mount through jacks. The vertical recoil force is taken directly by the track, through the sleepers and special rails, and the horizontal force merely slides the mount along a short distance on the track. The movement of the mount back into battery is secured by hand cranks and gearing leading to the front axle, and by means of which the front wheels can be slowly rotated. The recoil of the top carriage on proof firing (gun model 1870, 1881) was 1,450 millimeters and that of the car on the track 220 millimeters at 30 degrees and 460 millimeters at 10 degrees elevation.

101. *Elevating mechanism.*—This is exactly the same as that of the next mount except that a slip friction device is incorporated with it.

102. *Traversing mechanism.*—No internal traversing mechanism is provided. It is necessary to operate the mount on a curved track,

PLATE 55

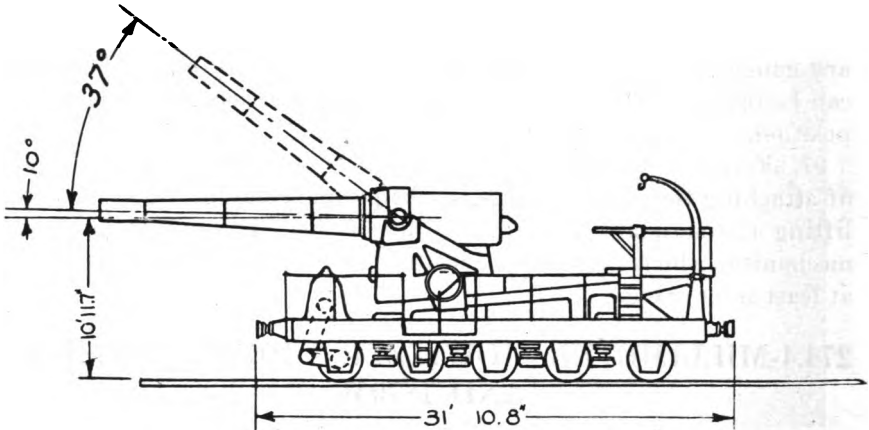

LEFT SIDE ELEVATION 274.4-MM. HOWITZER, MODEL 1870-1881 AND 1870M ON RAILWAY MOUNT, MODEL 1917.

and cranks and gearing leading to the front axle are provided for setting the mount exactly in azimuth and for returning it to its firing position after recoil.

103. *Railway car body.*—The railway car body includes the side rails of the racer of the original seacoast carriage as on the next mount described. In this case, however, all of the original transoms have been left in place, and a rectangular structural steel frame on which the axle boxes are mounted has been built around them.

104. *Anchorage.*—This mount was originally designed to operate with guys, like the 194.4 millimeter No. 5, but it was found that these were very heavy, and if they were dispensed with the mount would only slide back a short distance, and a mechanism could easily be provided for bringing it back to firing position. This mount requires, therefore, a track prepared with special bearing beams, on

which the sleepers can slide, similar to the track construction used with the larger sliding mounts later described. The sleepers, four in number, are located between the five axles, and the jacks which connect them to the mount are of the simple screw type, as used with the 194.4 millimeter mount No. 5. The upper ends of these jacks are castings which bolt directly onto the side rail castings of the old seacoast carriage.

105. *Trucks*.—This railway car is really one 5-axle truck. It is provided with brakes and semielliptical springs on each axle, but no equalizers. The wheels are solid and the entire truck construction is quite sturdy.

106. *Ammunition supply system*.—The ammunition supply system is quite simple on this mount. An auxiliary tray, located at the rear end of the mount, and capable of being swung on a vertical axis into the end door of the ammunition car, serves to transfer the shells from the tongs in the ammunition car to one mounted on a small jib crane at the back of the mount. From this it is dropped into a stationary loading tray and pushed along a removable loading tray into the gun. An operating platform is provided which slides back and forth with the carriage in recoil, so that when the gun is back in battery there is a clear walk-way entirely to the breech.

274.4-MILLIMETER GUN, MODEL 1893.

107. This mount, Plates 56 and 57, is improvised from a front pintle type of top-carriage recoil seacoast gun on two 4-wheel trucks. For reasons that will be mentioned later this mount did not see much service. The only opportunity that the writer had to inspect it was in the yards of the Chantier de la Loire at St. Nazaire, where they had probably been constructed and modified.

108. *Gun*.—The gun is of steel and is built up in the usual modern fashion. The breech mechanism is of the marine type, operated through gears, worms, etc., by the continuous rotation of a single handwheel. The firing mechanism is of the percussion type.

109. *Recoil mechanism*.—The gun is swung by its trunnions on a top carriage, which in turn rests on rollers on an inclined track. The gun and top carriage recoil together on firing, rolling up these rails for a distance of 1.90 meters. The recoil is checked by a hydraulic brake cylinder carried under the center transom of the carriage. This cylinder is about 14 inches outside diameter and the 3-inch piston rod is attached to the forward transom connecting the carriage rails. Counterrecoil is by gravity, and buffers are provided to stop it. For traveling, the top carriage is pushed back out of battery and secured in place.

110. *Elevating mechanism.*—The elevating mechanism consists of a train of spur gears, leading from a rack screwed to the gun to a handwheel which is provided with a clamp. There is no slip friction mechanism, and the gears are very light. The rack, for example, has only 1.75 inch face, with a tooth for each 2 inches along the circumference. The ratio of the gearing is such as to give approximately 1.8 degrees elevation of gun per turn of handwheel. Thirty-seven degrees elevation is provided for.

111. *Traversing mechanism.*—No internal traversing mechanism was provided. It is necessary to move the mount along a curved track to train the gun in azimuth.

112. *Gun carriage.*—The gun carriage, as above noted, is a standard type of coast-defense mount of the front pintle type. The date 1878 was noted on one carriage. The top carriage consists of two

PLATE 56

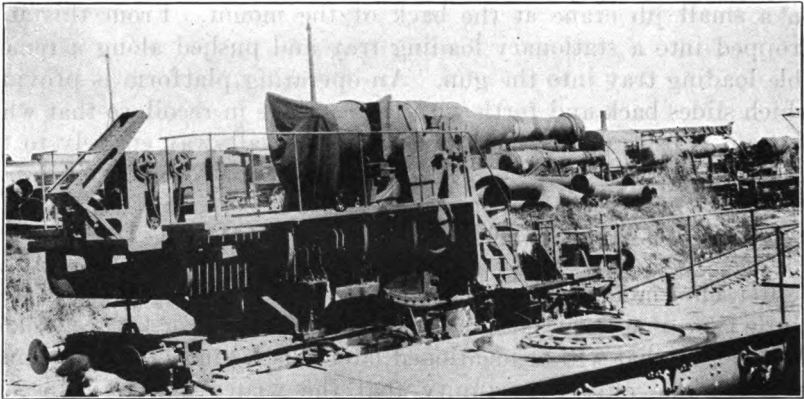

274.4-MM. GUN, MODEL 1893, RAILWAY MOUNT.

triangular side-frame castings, quite light and cut out so far as to form almost a truss, as shown in Plate 57. These side frames support the trunnion bearings and elevating mechanism and are held together by two cast transoms, one fairly light at the center of the front of the side frames and the other very heavy along the bottom. This last supports the recoil cylinder and has the two counterrecoil buffers imbedded in it. The carriage rolls on eight wheels, each about 10 inches in diameter by 5.5 inches face, and is supported on the two rails of the old seacoast carriage, which have been made into the car body in this mount.

113. *Railway car body.*—The lower portion of the old seacoast carriage consists of two heavy cast-iron beams or girders, about 30 inches in maximum depth, 5 inches in web thickness, and perhaps 8 inches in flange thickness. They are connected by a single cast

transom and three structural transoms, one at each end, carrying the center plate for the truck and two in the middle carrying the two central jack mechanisms. The cast transom was on the original carriage, but the others replace the original cast transoms which supported the front pintle and the rear traversing rollers. The center structural transom mounts two 25-inch wide wooden sleepers each connected to the car through two screw jacks of the same type as used with the heavy sliding mounts.

114. *Anchorage.*—The anchorage arrangements with this mount are in general similar to those employed with the 194.4 and 240-millimeter howitzers previously described. Longitudinal sleepers are laid on the ties parallel to the rails and the wooden sleepers are jacked down onto them until part of the weight of the mount is supported in this way. In front of the mount a rail clamp is secured

PLATE 57

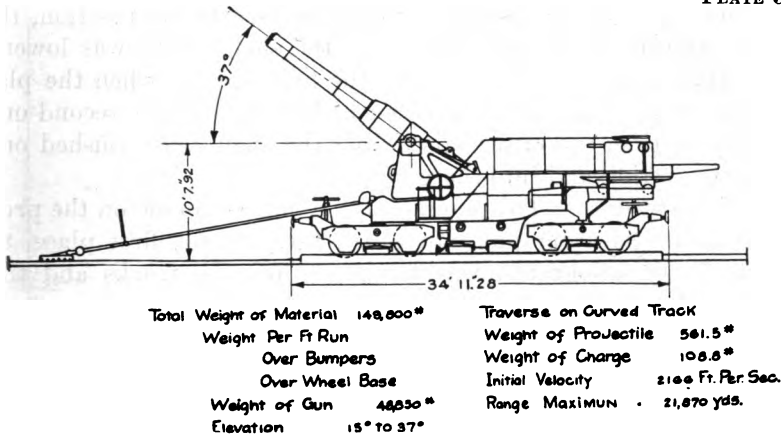

ELEVATION VIEW OF 274.4-MM. GUN, MODEL 1893, ON RAILWAY MOUNT ANCHORED FOR FIRING.

to each rail and tension rods with turnbuckles extend from these to special fastenings on the front of the mount. The sleepers take the vertical load of fire and the guys and rail clamps the horizontal.

115. *Trucks.*—The trucks are four wheel, with structural side frames, outside journals, semielliptical springs without equalizers, and are equipped with hand brakes. Each truck is provided with a sleeper and two jacks similar to those described above. The truck construction is extremely light; the wheels are about 35 inches in diameter and have very small spokes. The journals appear to be about 4 by 7 inches, and the whole construction resembles that used under the light French freight cars.

116. *Ammunition supply system.*—The ammunition supply system of this mount is rather complicated and interesting and would seem

to be the forerunner of the transbordeur system used with the large sliding type mounts. The entire rear operating platform rolls on rails located along the inside of the car body side frames, and by means of an operating handwheel and gearing can be moved back and forth a distance somewhat greater than the recoil of the gun. On this platform a special ammunition tray in four separate sections is mounted. At the rear is a hinged trough forming the first section. This can be swung down to a horizontal position to extend inside the ammunition car when the operating platform is pushed back to its rearmost position. The second section is a short piece of stationary tray to which the first section is hinged. The third section, just forward, is another length of tray which can be moved vertically, by means of a handwheel and gearing, from the level of the first and second trays to that of the breech. The fourth section is another hinged trough at the level of the breech. When it is let down and the operating platform is run forward to its extreme position, this section projects inside the breech and the shell which was lowered by the ammunition car trolley onto the first section, when the platform was in the rear, can now be pushed along over the second onto the third section, the latter raised, and the shell again pushed onto the fourth section and into the gun.

117. *Maintenance.*—This mount gave so much trouble on the proof tests that it was never put into active use. In the first place, the weight, 70,000 kilograms, was too much for the trucks and they developed hot boxes, etc., to an impracticable extent. Second, the elevating gear was weak and had no slip friction, so that the whip of the gun broke the elevating pinion. Third, in order to lighten the mount, a number of circular holes were cut in the side frames of the cast-iron car body girder (racer of the old sea-coast carriage). This so weakened the girder that it fractured from one of the holes out at a point midway between center pin and forward car-body jack (just under gun trunnion).

274.4-MILLIMETER GUN, MODEL 1893, 1896, ON SLIDING MOUNT.

118. This is the first mount, Plate 58, of the famous series of rigid girder "Glissement" type that owed its appearance to the desperate need of the French armies for heavy mobile artillery during the first few years of the war. The principle of dissipating the energy of recoil through a series of friction beams was not new, for it had been employed on some of the improvised mounts, and the essentials of the principle had been employed even in our own Civil War. The combination of a heavy gun swung directly by its trunnions in bearings mounted on the side girders of the car with no recoil mechanism whatsoever was new and is a bit of daring design. It did

not appeal to American designers at first and perhaps does not to many now. Under the conditions that prevailed for a long time in France—that is, a more or less fixed line—it was possible to construct great numbers of firing curves, and transportation facilities were

PLATE 58

274 $\frac{7}{16}$ SCHNEIDER . MODEL 1893 - 1896 ..

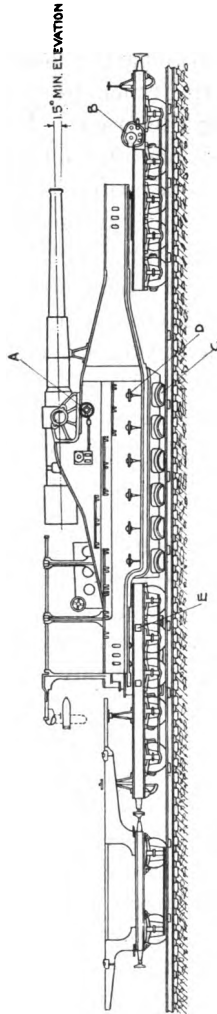

relatively good. The mount worked most satisfactorily under these conditions, hence was a success.

119. *Gun.*—The gun is of steel with modified Manz breech mechanism. The gun is provided with rigid trunnions of large diameter

on which it swings between the girders of the car body. Provision is made in the trunnion supports for adjusting the center line of the trunnions.

120. *Recoil mechanism.*—The recoil on this mount is of the sliding type. The full shock of recoil is received by the car body, which slides backward on the track about a meter. Counter-recoil, or the return of the gun to the firing position, is accomplished by means of a so-called translating mechanism—a handwheel and a system of gearing on the truck by means of which the mount can be moved slowly along the track. For each mount two of these mechanisms are provided, one on each side of the front truck and each requires two men for operation. Details are shown on Plates 76–77. In this particular mount the gears and sprockets are so proportioned that one turn of the car wheel is produced by 132 turns of the handwheel. The handwheel radius is 0.3 meter. A clutch is provided in the mechanism which is thrown out on firing; for traveling the chain from the axle to the jackshaft is also removed. The brakes used with this type of recoil are the sleepers on which the mount rests when firing. They will be more fully described under “Anchorage.”

121. *Elevating mechanism.*—Elevation from 0 to 40 degrees is provided, and the gun is provided with antifriction auxiliary trunnions to lessen the effort of elevating. The gear train employed consists of a rack bolted to the gun, a pinion connected to a worm wheel through a slip-friction device, and a worm leading to the handwheel. One turn of the handwheel moves the gun through 0.65 degrees.

122. *Traversing mechanism.*—On all of the mounts of this type in use in the French Army no provision is made in the body of the car for traversing the gun. When it is desired to operate on a given target, a firing position is selected near an existing railway line. From this line a spur is constructed ending in a section of curved track of not less than 50 meters radius. This curve is so located that a tangent drawn at about its middle point passes through the target. The mount is placed on this curve for firing and may be traversed by moving it along the curve with the translating mechanism described under “Recoil mechanism.”

123. *Gun carriage, railway car body.*—In this design the gun carriage and railway car body are one. It is composed of two structural steel box girders fastened side by side by suitable transoms and decking. On each side girder, Plate 58, is a heavy cast-steel trunnion support. At both front and rear the car body rests on the trucks through a conical roller nest. King pins of special design are employed.

124. *Anchorage.*—The anchorage is of the track platform type, although really the track must be constructed with especially long

ties, closely spaced, before the real platform or bearing stringers are put in place. This platform construction is shown on Plate 59, and consists of eight I beams secured to the ties parallel to the rails. These beams are provided in sections of about 2 meters length, and when placed for action are bolted together into four parallel lengths, each consisting of two beams. Usually a length of about 40 meters is employed. They are then attached by means of screw spikes to the ties. A minimum of 30 minutes is required to connect or disconnect all of these beams, and even if the mount were forced to retreat and leave the firing beams behind the loss would not be serious. In transit all the firing beams for one mount are carried on one flat car.

125. The car body is provided with six wooden sleepers extending across under the central portion and attached to jackscrews and also with two similar longitudinal sleepers under the rear truck. These jacks are operated by the handles seen on the side of the car

PLATE 59

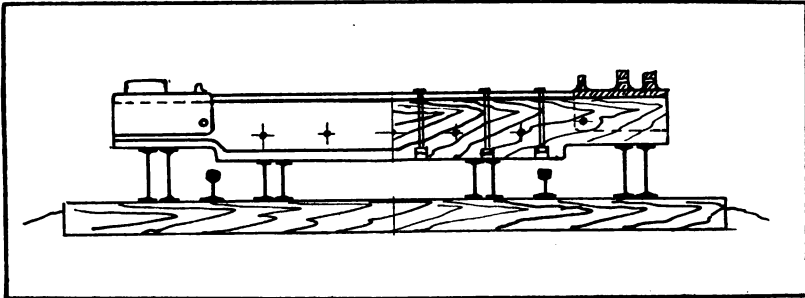

TRACK ARRANGEMENT FOR "GLISSEMENT" TYPE OF RAILWAY MOUNTS.

and of the rear truck. By operating them the sleepers can be forced down hard on the firing beams, or bearing stringers, so that a considerable portion (about one-half) of the weight of the mount is transferred from the trucks to the sleepers. When the piece is fired the friction between these sleepers and the bearing stringers reduces considerably the distance through which the piece recoils. This sliding of the sleepers on the firing beams has given rise to the term "Glissement," which is ordinarily applied to all of these mounts. When properly anchored this sliding mount will ordinarily not recoil a distance of more than 1 meter. The jacks are incorporated inside the box girders forming the side frames of the mount and each consists of a screw, operated through a worm wheel. The radius of the crank is 0.20 meter and one turn moves the sleepers about 0.3 centimeter.

126. *Trucks.*—The trucks contain five axles each, have a structural frame, 1-meter wheels, and semielliptic springs without equalizers.

The center pins are slightly inside the center of the trucks. It is understood that these last two points are due to improvisations which had to be made in the manufacture. As already noted, two translating mechanisms are mounted on the front truck and four jack screws operating two longitudinal sleepers on the rear.

127. *Ammunition supply system.*—Owing to the fact that the mount moves backward in firing, it is not possible to keep the ammunition car immediately behind it, and a shuttle car, called a transbordeur, shown at the left on Plate 58, is provided. It will be observed that at both ends are located hinges, so that the end sections may be folded in transit. When in action the projectile is placed on a small rolling truck on the transbordeur by means of the overhead trolley in the ammunition car. The transbordeur is then moved up to the mount and the shot truck run forward to the extreme position, where the projectile is picked up by means of the tongs attached to the overhead trolley on the rear end of the gun carriage. By means of this trolley it is taken forward and placed on the ammunition table, from which it is pushed into the gun by a mechanical rammer. The powder charge is divided into small sections (quarters) and is brought up by hand. The speed of firing with this mount is about one shot in from three to four minutes, this much time being necessary for translating forward into firing position, re-laying, reloading, etc.

128. *Maintenance.*—The problem of maintenance of sliding-type mounts is a negligible one. The entire mount is of such sturdy construction that even with careless handling no damage is likely to be suffered. The officers who have commanded batteries of these mounts, as well as officers in charge of repair shops, report that the bulk of maintenance has been on firing mechanisms.

274.4-MILLIMETER GUN, MODEL 1893, 1896, WITH RECOIL ON MOUNT.

129. This mount, Plates 60–62, comprises a naval gun and cradle mounted on a special design of railway car. This mount is peculiar in two respects in that it is the only one in which provision is made for traversing the car body on the trucks, and likewise in that it is one of the two types of which armor is provided for the protection of the crew against aerial machine-gun fire, fragments of shells, etc. It is peculiar that the designers of this mount seemed to feel that the car-body traverse had not proved of any particular value, while the designers of similar mounts in the British Army felt that that feature had been of such value as to warrant incorporating it in all of their most recently designed mounts.

130. *Gun.*—The gun is the same as the one used on the mount previously described. It is adapted for use in a cradle instead of being provided with trunnions, however.

131. *Recoil mechanism.*—Cradle-sliding recoil is provided for on this mount. Because of the existence of the cradle the extent of the sliding of the entire mount is reduced to about 40 centimeters.

PLATE 60

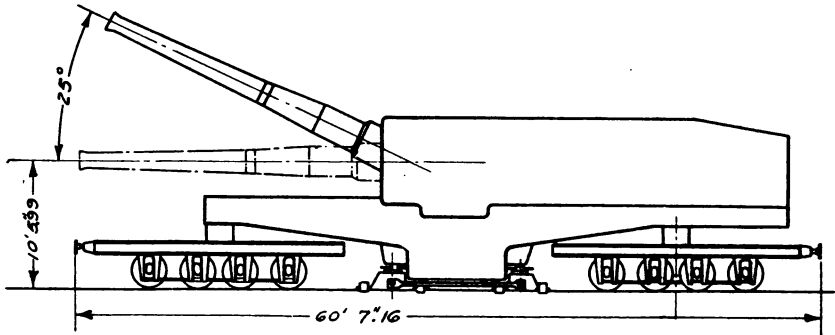

274.4-MM. GUN, MODEL 1893, 1896, WITH CRADLE RECOIL SYSTEM AND MOUNT SLIDING. FIRING POSITION.

132. *Elevating mechanism.*—This elevating mechanism includes a screw instead of the usual rack. The extent of elevation is 25°.

133. *Traversing mechanism.*—Car-body traverse is provided to the extent of 1 degree on each side of the center line. The mount must, therefore, ordinarily be fired from a curved epi. Exact training can be secured by the car-body traverse, and, indeed, it is possible to fire several shots before moving the mount back to the

PLATE 61

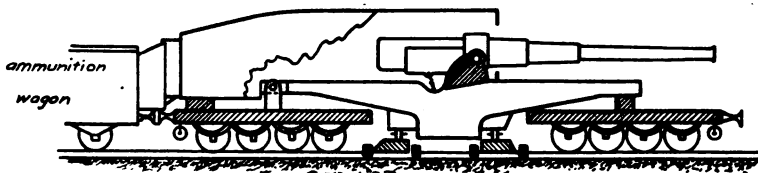

DUE TO CRADLE RECOIL SYSTEM THE "SLIDE" OF MOUNT IS SO REDUCED TO PERMIT COUPLING TO AMMUNITION CAR DURING ACTION.

original position, its traverse being sufficient to take care of the change in direction. The traversing mechanism consists of a screw arrangement on the rear truck, by means of which the rear end of the car body may be moved back and forth relative to the truck pivoting about the front truck.

134. *Gun carriage and railway car body.*—The gun carriage and railway car body are combined in one. This consists of two steel girders between which the cradle swings. The rear of the mount

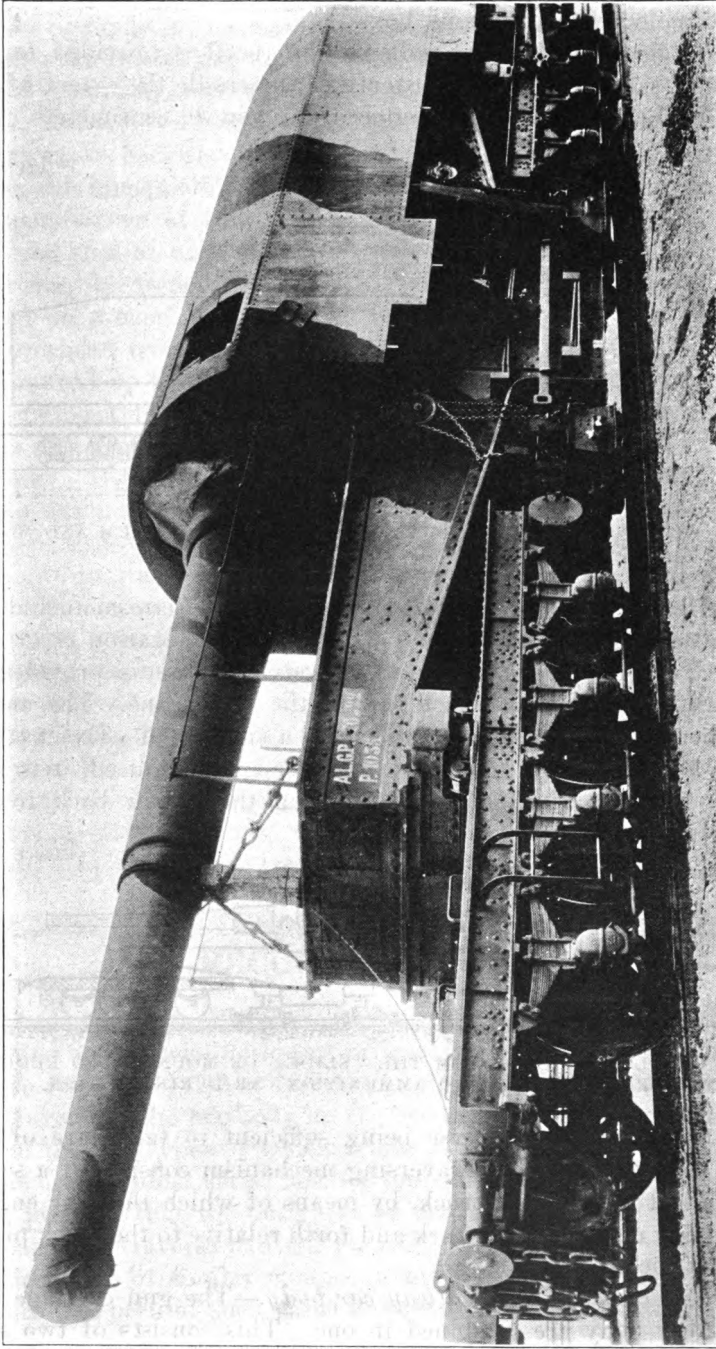

285-MM. GUN, MODEL 1893, 1898, ON RAILWAY MOUNT, WITH CRADLE RECOIL SYSTEM AND SLIGHT CAR BODY TRAVERSE, READY FOR TRAVELING.

is armored to protect the crew against aerial machine-gun fire, shell fragments, etc. It may be well to mention here an experience related by a French officer with reference to the armor. He was in charge of mounts having no armor. German aviators located them and risked flying sufficiently low to enable them to fire on the crews and general personnel of the battery with their machine guns. The batteries were not at that time provided with machine guns and were not able to defend themselves except with small rifles. The officer said that the aviator flew so low over his gun that some of his men even resorted to the throwing of stones. This experience does not seem to have resulted in any very general use of armor, however.

PLATE 63

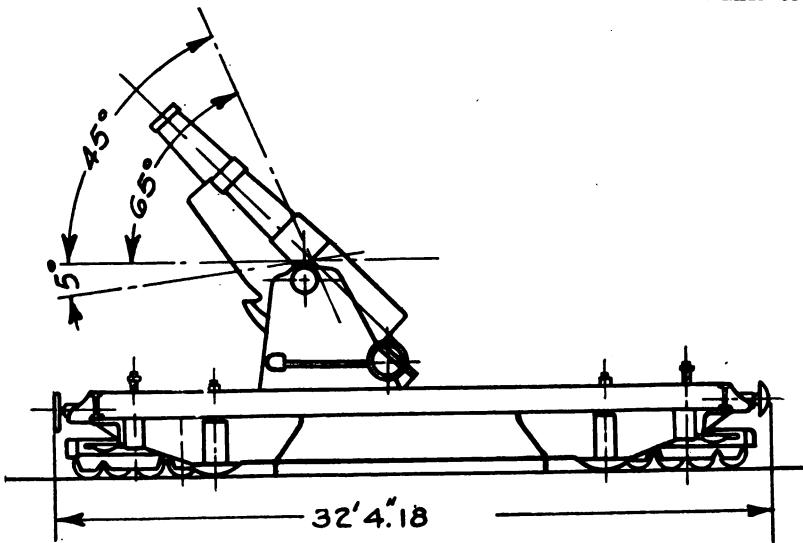

293-MM. MORTAR, MODEL 1903, ON RAILWAY MOUNT.

135. *System of anchorage.*—The portion of the track on which the mount is to be operated must be reinforced by additional and special ties. When the mount is in its proper position, two metal sleepers are lowered onto the rails by jack screws. Rail clamps are provided for additional fastening, and a windlass is provided under the floor of the front truck for drawing the mount back to its proper position and training the gun exactly in azimuth.

136. *Ammunition supply system.*—The ammunition car is coupled directly behind the mount, and a covered passage is provided between the two. A track reaching from the breech of the gun and extendable into the ammunition car is provided for the transfer of the ammunition. The projectiles are placed on the small shot truck by a chain hoist attached to a trolley in the ammunition car.

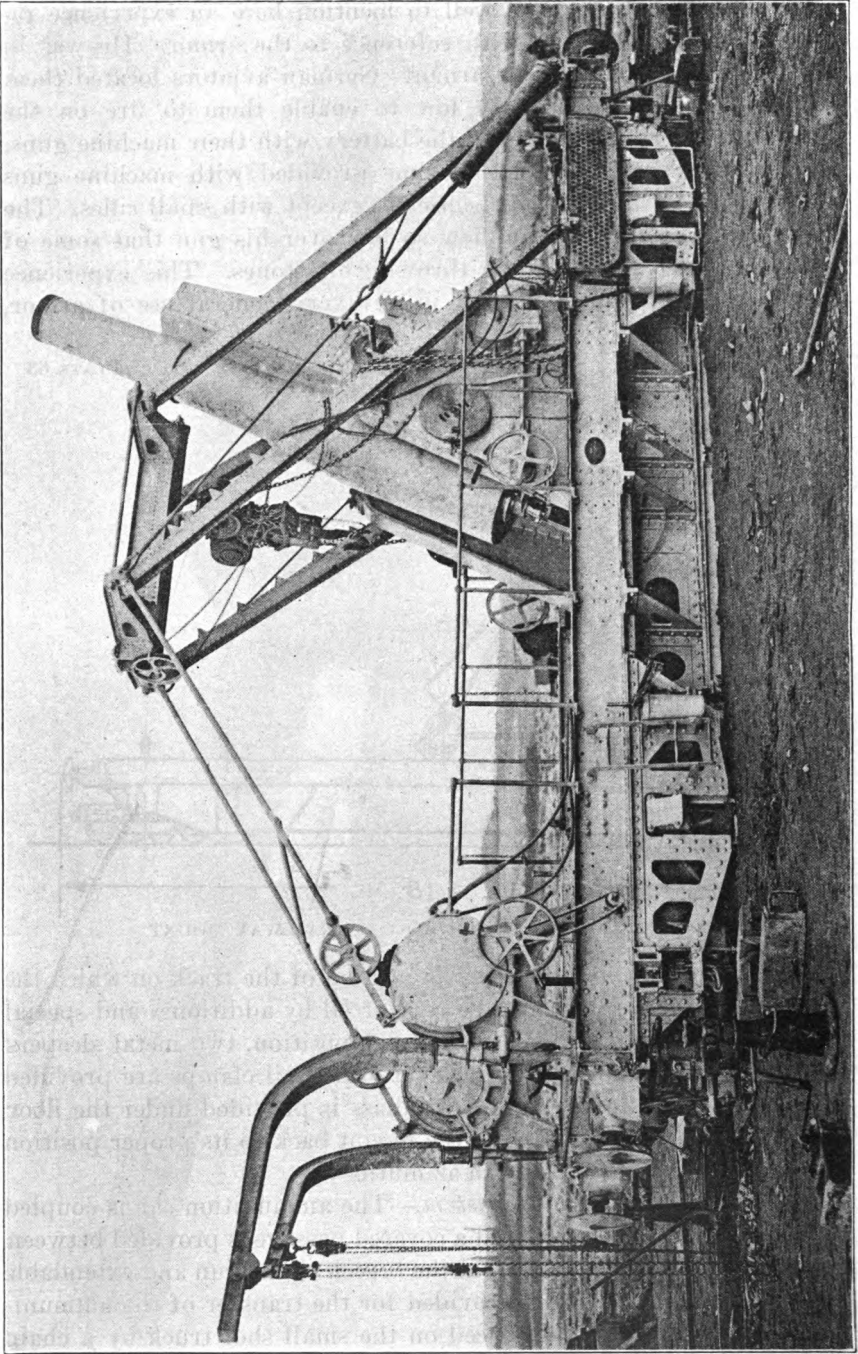

293-MM. MORTAR, MODEL 1908, EMPLACED FOR FIRING, MOUNT ON BASE RING AND TRUCK AXLES RAISED TO CLEAR.

285-MILLIMETER GUN, MODEL 1893, 1896.

137. This gun is the 274.4 millimeter, Model 1893, 1896, rebored to a larger caliber. The mount is identical with the preceding.

293-MILLIMETER MORTAR, MODEL 1903.

138. This mount is almost identical in design with that for the 240-millimeter gun, Model 1903, No. 20. Only the few points of difference will be mentioned. It is shown on Plates 63-65.

PLATE 65

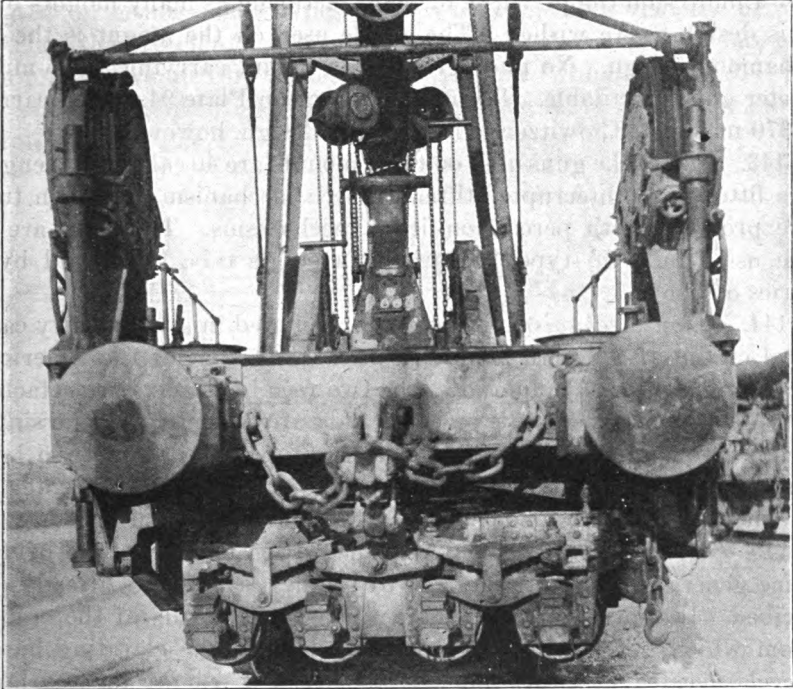

END VIEW OF MOUNT ON STANDARD GAUGE TRACK, SHOWING DISPOSITION OF NARROW GAUGE TRUCKS.

139. *Gun.*—The mortar is 15 calibers in length and is fitted with a breech mechanism of the interrupted screw type automatically operated by a special recuperator. Hand firing with percussion mechanism or electric firing can be used.

140. *Recoil mechanism.*—Cradle recoil only is employed with this mount, the side frames of the carriage being fixed rigidly to the car body. The length of recoil is 0.70 meter.

141. *Ammunition supply system.*—The system of supply and the mechanisms are the same as on mount No. 20. The loading angle is 45 degrees, however.

305-MILLIMETER GUN, MODEL 1893, 1896, 1906, ON BATIGNOLLES MOUNT.

142. This mount is a development of the World War and represents a very admirable design. The same design of mount was used to carry 305 and 340 millimeter guns and 370-millimeter howitzers. Some of the 370-millimeter howitzers were simply rebored 305-millimeter guns; in these cases the mounts used were simply the 305-millimeter mounts. The mount takes its name from the Society de Batignolles, under whose supervision it was designed. Shortly after our entry into the war we purchased from the Society de Batignolles for a lump sum the privilege of manufacturing as many mounts over this design as we wished. The cradle used on the mount is the St. Chamond design. No photograph of a mount carrying a 305-millimeter gun is available. The mount shown on Plate 94, which carries a 370-millimeter howitzer, is identical in design, however.

143. *Gun.*—The guns used on these mounts are 40 calibers in length, are fitted with interrupted-thread breech mechanism, which in turn are provided with percussion-firing mechanisms. The guns are of the usual built-up type, comprising a single tube reinforced by a series of hoops.

144. *Recoil mechanism.*—The gun is mounted in a very heavy cast-steel cradle of a design almost identical with that of the American 12-inch gun, No. 6, Volume I. The two recoil cylinders are attached to the bottom of the cradle on either side of the center and the single recuperator cylinder in the center at the top. The recoil is so long with this gun that it is necessary to dig a pit under the center of the mount, Plate 66, for operation at high angles.

145. *Elevating mechanism.*—The elevating mechanism is of the same general type found on most of the heavier mounts already described. It comprises a rack bolted to the right side of the cradle, from which gears, pinions, and shafts lead to the elevating hand-wheels, located at either side of the forward end of the carriage. The maximum elevation is 38 degrees. The elevating mechanism is provided with an antifriction device, and a slip-friction device is incorporated in the gear train.

146. *Traversing mechanism.*—See "Traversing mechanism" for the American 12-inch gun, Paragraph 170, Volume I.

147. *Gun carriage.*—See Paragraph 171, Volume I.

148. *Railway car body.*—There is nothing unusual in this car. It is, perhaps, the simplest in design of all the heavy gun cars. It is composed of two simple but heavy built-up plate girders, joined by several heavy transoms. The bottom chords of the girders are provided with special brackets which serve as holders or stops for the special anchoring wedges.

149. *System of anchorage.*—See Paragraphs 173 and 174, Volume I.

150. *Ammunition supply system.*—The mechanisms employed on the French mount are not the same as those on the American mount. In constructing our mounts it was felt that the French design was entirely too elaborate. This French design, Plate 94, comprises an inclined elevator at the rear of the working platform by which the projectile is drawn up from the ammunition car to a hinged tray on the stationary table. The rear of this tray can be raised by a lever, thereby causing the projectile to slide onto the tray of the movable table. This table is then rolled forward by means of two handwheels located on either side, giving the greatest possible velocity before it strikes the breech of the gun. The projectile slides forward into the gun and is rammed by a mechanical rammer which is operated by the same two handwheels used in moving the table. See also Paragraph 176, Volume I.

PLATE 66

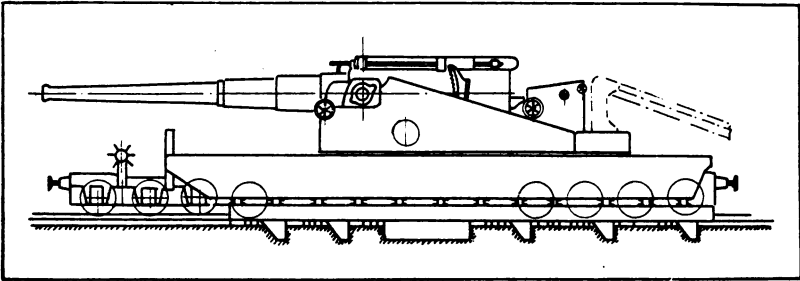

ANCHORAGE ARRANGEMENT OF BATIGNOLLES TYPE RAILWAY MOUNT.

151. *Maintenance.*—It is unlikely that any great amount of maintenance is necessary if the mount is handled with care. It was observed at Camp Mailly that all mounts provided with recoil brakes, recuperators, etc., are given constant attention to keep them in perfect condition. These attentions are minor, it is true, yet really necessary. The gun car is so sturdy that nothing about it is likely to require attention. This is likewise true of the railway car body and firing platform. One gets the impression, however, that it is a mount which requires handling by skilled and careful men. Carelessness in placing or removing any of the sections of the firing platform may easily damage the section to an extent that will necessitate repair. One is impressed with the fact that officers who were handling these mounts, observed on the French front, are engineers of the highest type. They were perfectly familiar with the construction of the inside of every part of their machine. No single question was asked which they were not able to answer at once by means of free-hand sketches as well as mathematical demonstrations. Whether this

indicates that it is considered necessary in French artillery to supply this type of officer for these mounts is a question.

152. *Difficulties involved in the service.*—It can not be said that there are any particular difficulties involved in the service of these mounts. If the special firing platform car is kept in fine working order, the firing platform is not difficult to place and the time consumed in placing the platforms can not be considered excessive. The ammunition supply system is very efficient, and experience has proved in the field that the gun can be served with very satisfactory speed. No difficulties whatever have either been observed or reported. One of the group commanders consulted had been in charge

PLATE 67

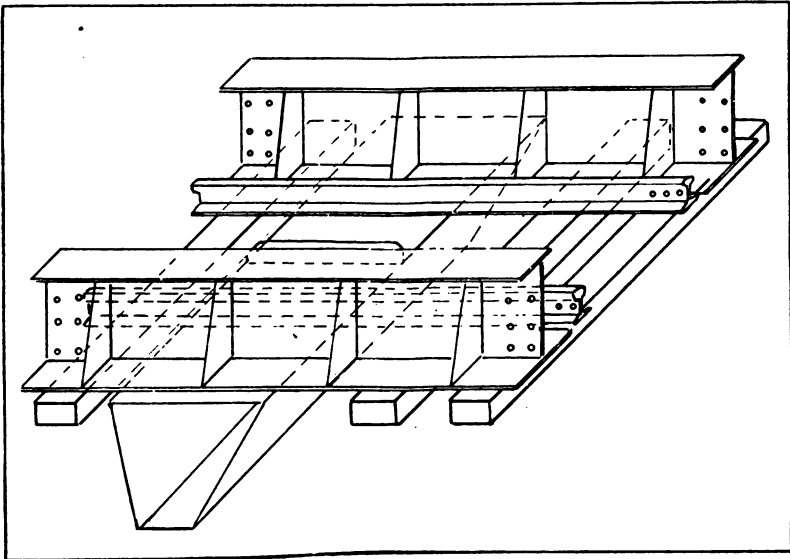

SECTION OF FIRING PLATFORM, BATINGOLLES TYPE EMPLACEMENT.

of mounts of this kind for three years and was very enthusiastic about them. It might be noted that this officer, as well as all of his assistant officers, were from the navy. It was a striking fact that none of them seemed able to comprehend the practicability of a railway mount without a recoil mechanism as well as a traversing mechanism, but especially a recoil mechanism.

153. *Merits and demerits.*—See Paragraphs 179–180, Volume I.

305-MILLIMETER GUN, MODEL 1893, 1896, ON ST. CHAMOND MOUNT.

154. This mount, Plates 68–69, comprises a seacoast gun and its all-around fire carriage mounted on a drop-frame railway car. It is understood that it was one of the first mounts constructed by the

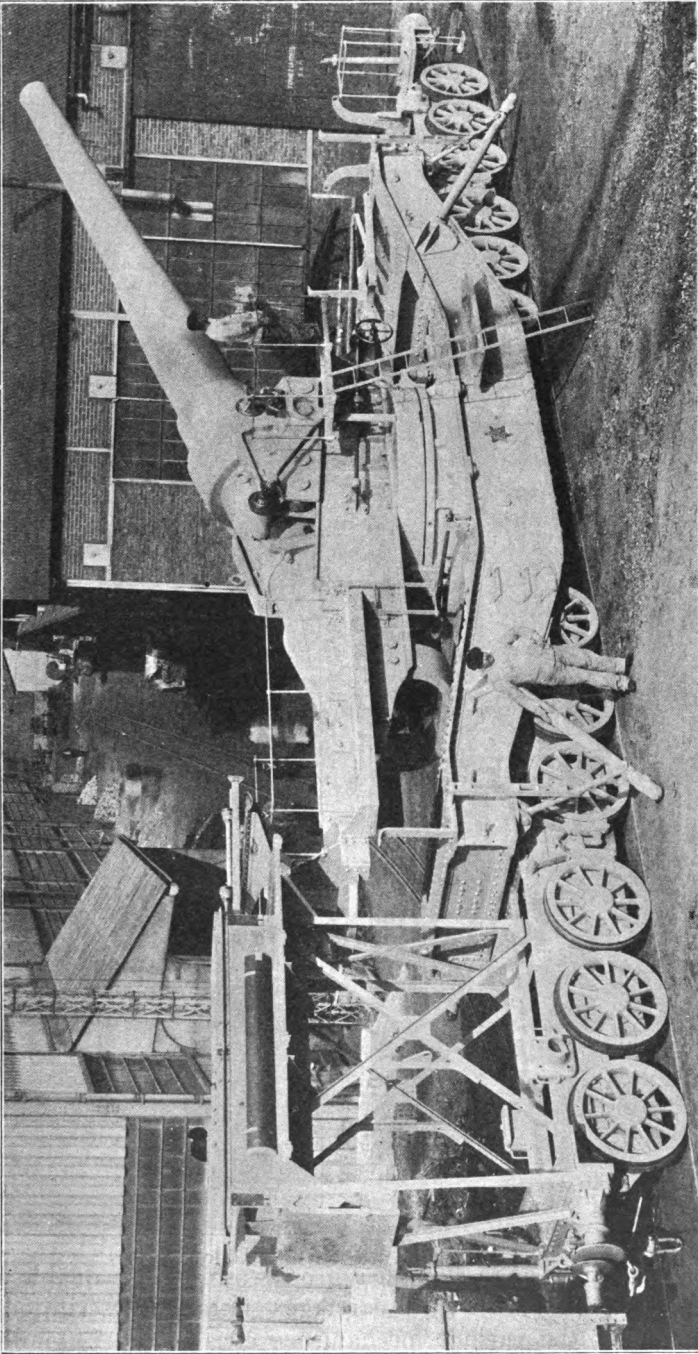

305-MM. GUN, MODEL 1893, 1896, ON ST. CHAMOND MOUNT WITH TWO TWELVE WHEEL INSIDE JOURNAL TRUCKS.

French after the outbreak of the war. In all of the essentials it is exactly the same as the 240-millimeter gun mount, No. 16. In fact the 240-millimeter mounts originally carried 305-millimeter guns until it was found that the mount so limited the field of use-

PLATE 69

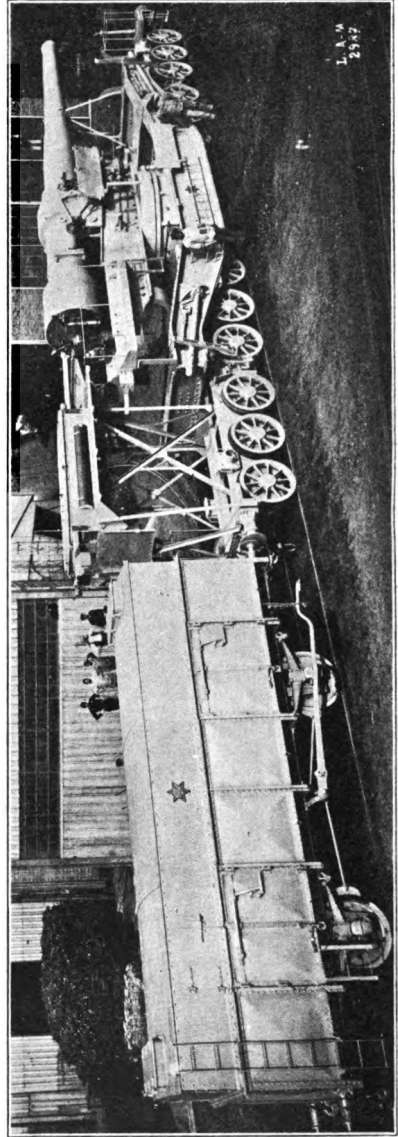
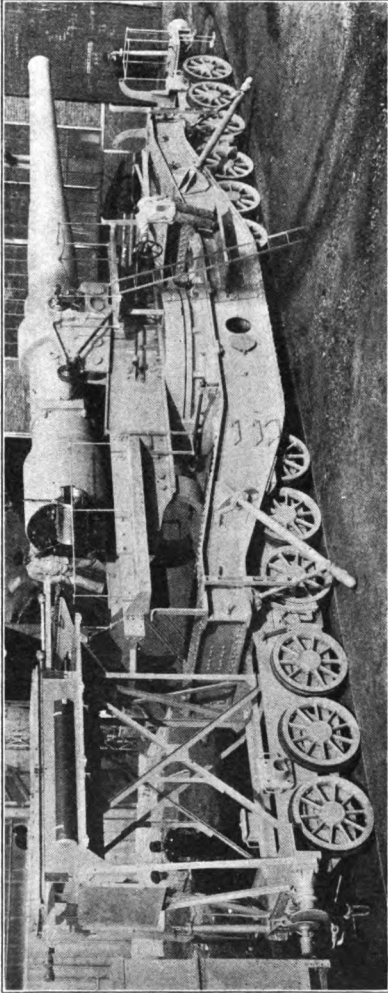

TWO VIEWS OF ST. CHAMOND MOUNT WITH 305-MM. GUN.

fulness of the gun as to make it a gross waste of so valuable a piece to have it mounted on such a carriage. Detailed descriptions have been given of the various mechanisms, etc., of the 240-millimeter mount, and only the few points of difference as required by the larger gun will be discussed here.

155. *Elevating mechanism.*—The power of the gun made it impossible to operate it at wide angles to the track and while operating with the gun pointing over either end of the car body the length of the gun is so great as to limit the elevation to 20 degrees.

156. *Traversing mechanism.*—The power of the gun is too great for the anchorage when operated at wide angles to the track. The traverse was limited to 10 degrees on either side of the center line of the car. Nearly all of the weight of the rotating portion of the mount was carried upon a central pivot in order to reduce the effort of traversing.

157. *System of anchorage.*—See Paragraph 72.

158. *Demerits.*—This mount would seem to give a definite indication of the limitations of this type of anchorage. The recoil stress, presumably the vertical pressure on the rails of the carriage, is given as 900 metric tons. The brake effort is only 130 metric tons. The 400-millimeter St. Chamond mount, which has a somewhat similar anchorage arrangement, has a brake effort of 300 tons, but since there is no top carriage recoil the mount is not subjected to the heavy vertical load, and the anchorage seems satisfactory.

305-MILLIMETER GUN, MODEL 1893, 1896, ON SLIDING MOUNT.

159. The gun used on this mount, Plates 70–72, is exactly the same as the 40-caliber gun used on the Batignolles and St. Chamond

PLATE 70

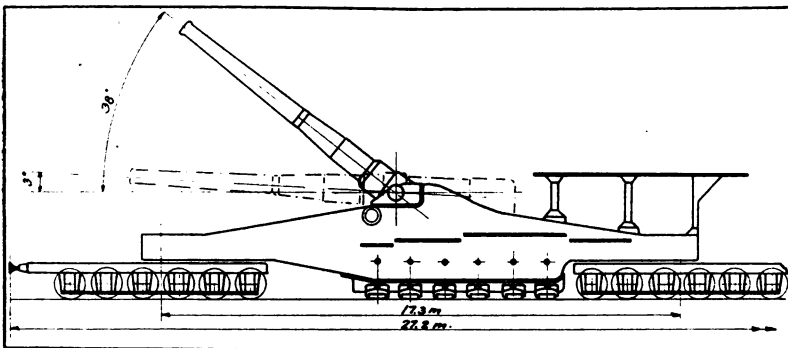

OUTLINE OF 305-MM. GUN ON SLIDING MOUNT, SHOWING LOADING ANGLE AND EXTREME ELEVATION OF GUN.

mounts. It will be seen in the tables, section 4, that when mounted on this sliding type carriage the gun has a range of 30.9 kilometers, as against 27 on the Batignolles carriage and only 20 on the St. Chamond carriage. This sliding type mount does not differ in the

PLATE 71

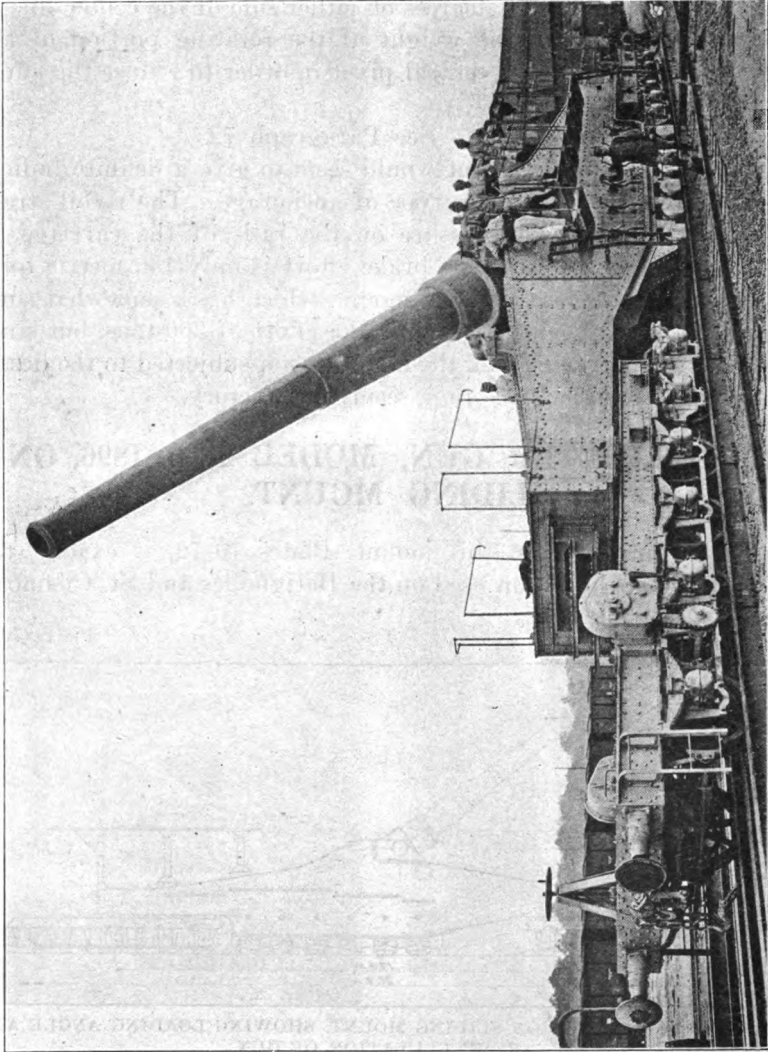

305-MM. GUN, MODEL 1893, 1896, ON SLIDING MOUNT WITH STRUCTURAL BEAMS SHOWN UNDER JACK SLEEPERS.

design of any of its essential details from the 274.4-millimeter mount, No. 23. It may be of interest to note that in the precipitously rapid advance that the Germans were able to make in their drive between Soissons and Rheims in June, 1918, it became necessary to abandon a battery of these 305-millimeter gun mounts. They were the first French railway mounts captured by the Germans, and they were in good condition. The Germans had succeeded in locat-

PLATE 72

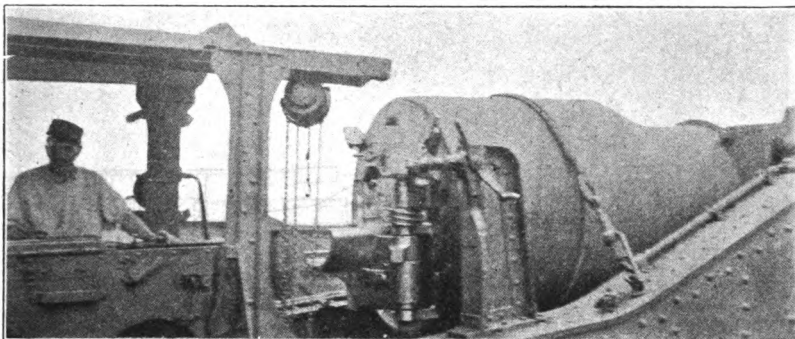

BREECH MECHANISM ASSEMBLY.

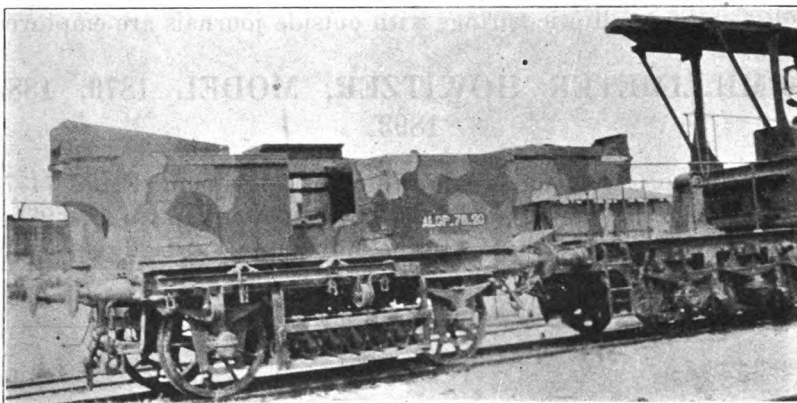

SHUTTLE CAR OR TRANSBORDEUR FOR DELIVERING AMMUNITION TO SLIDING MOUNTS FROM DUMP OR CAR IN REAR.

ing the battery very accurately and completely smothered it with shell fire. So effective was the shelling that it was impossible for the personnel to either remove the mounts or even damage them sufficiently to render them useless. They did their best in hammering up with sledges some of the vital parts. About half of the personnel was killed or badly wounded and left behind. At the time it was not the habit of such batteries to carry thermite shells with which to destroy a gun under such conditions.

305-MILLIMETER GUN, MODEL 1906, 1910, ON SLIDING MOUNT.

160. This mount, Plate 73, is, with the exception of a few minor improvements, quite similar to the above. The chief and, perhaps, only difference worthy of discussion is in the trucks.

PLATE 73

305 MM GUN MODEL OF 1906-1910 (SCHNEIDER)

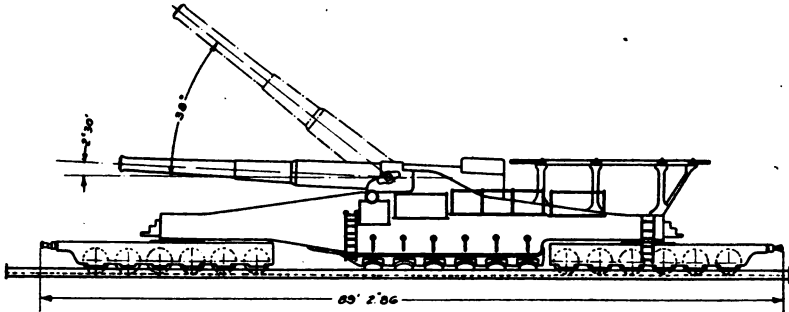

161. *Trucks.*—The trucks contain six axles each, with 0.90-meter wheels. The side frames are of heavy plate steel reinforced with angles, and semielliptic springs with outside journals are employed.

320-MILLIMETER HOWITZER, MODEL 1870, 1884, 1893.

162. This piece is mounted on a sliding type mount, Plates 74-77, which is similar in practically all of its essentials to the 274.4-millimeter mount, No. 23. Only the differences will be discussed.

PLATE 74

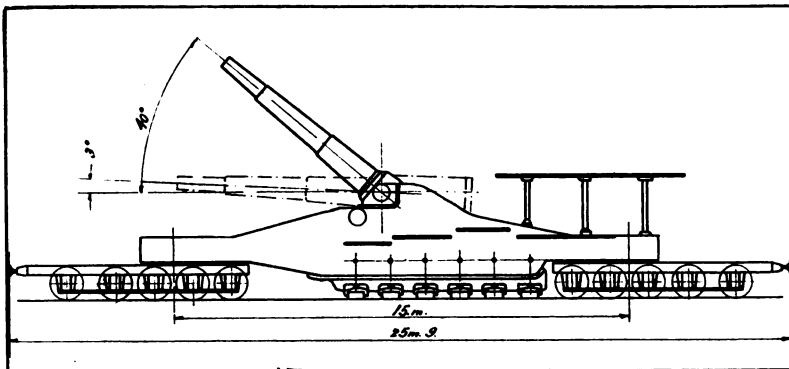

LEFT SIDE ELEVATION 320-MM. HOWITZER ON SLIDING RAILWAY MOUNT (SCHNEIDER).

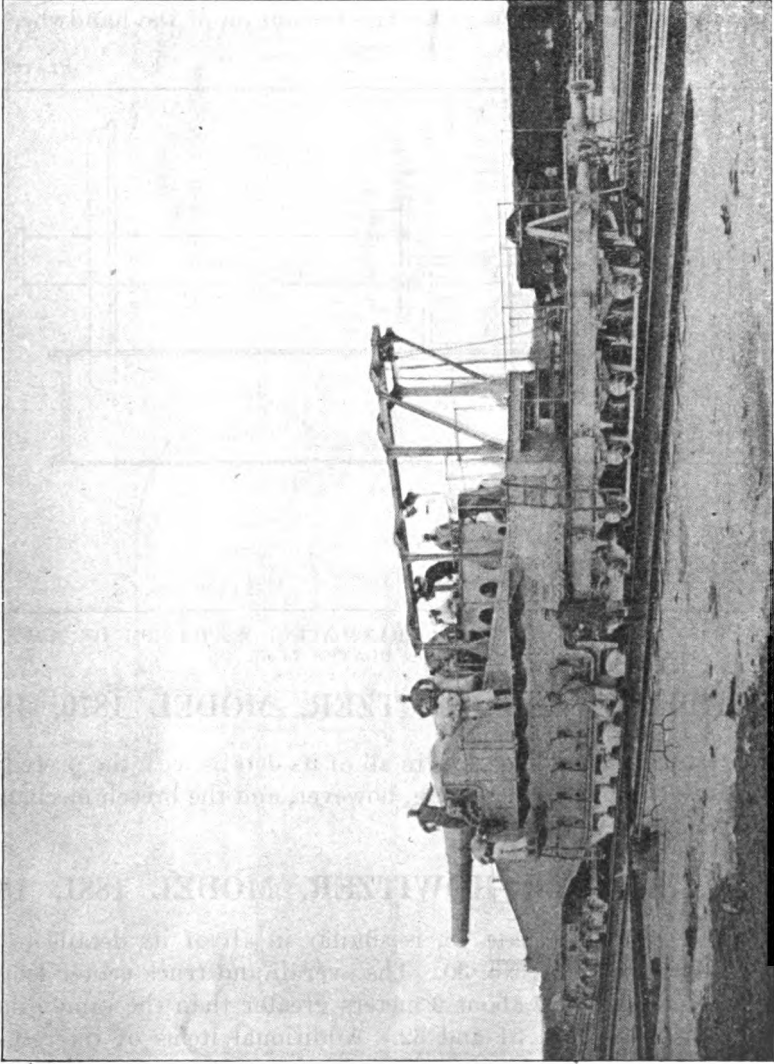

RAILWAY MOUNT OF SCHEIDER DESIGN MOUNTING 320-MM. HOWITZER, MODEL 1870, 1884, 1893.

163. *Gun.*—The guns used with these mounts comprise a cast-iron body reinforced with exterior hoops and interior liner at the breech end. The breech mechanism is of the interrupted screw type, usually the Farcot type.

164. *Elevating mechanism.*—This is similar in general design to that on the 274.4-millimeter mount. The gear ratio is higher, however, one degree of elevation for one revolution of the handwheel.

PLATE 76

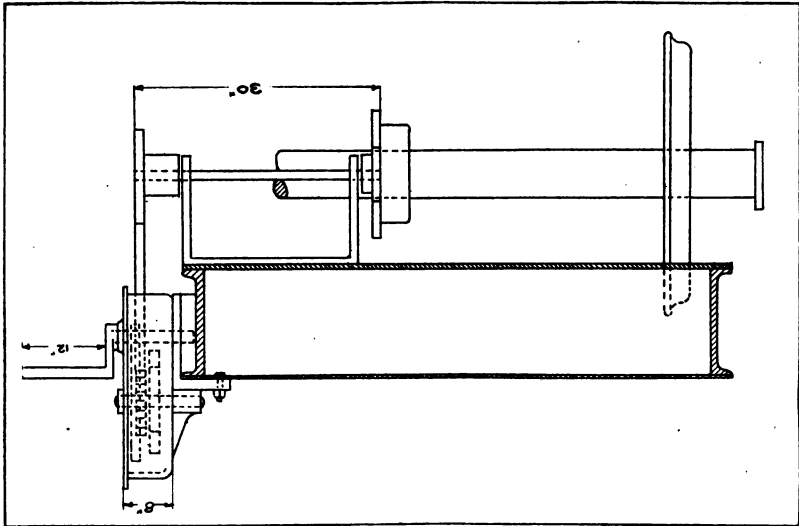

END VIEW SKETCH OF MOUNT TRANSLATING MECHANISM OF MOUNTS SHOWN ON PLATES 74-75.

320-MILLIMETER HOWITZER, MODEL 1870, 1881.

165. This mount is identical in all of its details with the preceding. The gun is only 25 calibers long, however, and the breech mechanism is of the marine type.

320-MILLIMETER HOWITZER, MODEL 1881, 1884.

166. This mount, Plate 78, is similar in all of its details to the 305-millimeter mount, No. 30. The overall and truck-center lengths are the same, and are about 2 meters greater than the same dimensions of mounts Nos. 31 and 32. Additional items of interest are as follows:

167. *Elevating mechanism.*—One turn of the handwheel moves the gun through 0.45 degrees. The antifriction device on this mount comprises a set of roller bearings, the rollers being about 2 inches in diameter by 6 inches in length. The bearing in which they roll is in turn supported on a column of Belleville springs which permit the main trunnion to seat in the bearing on firing.

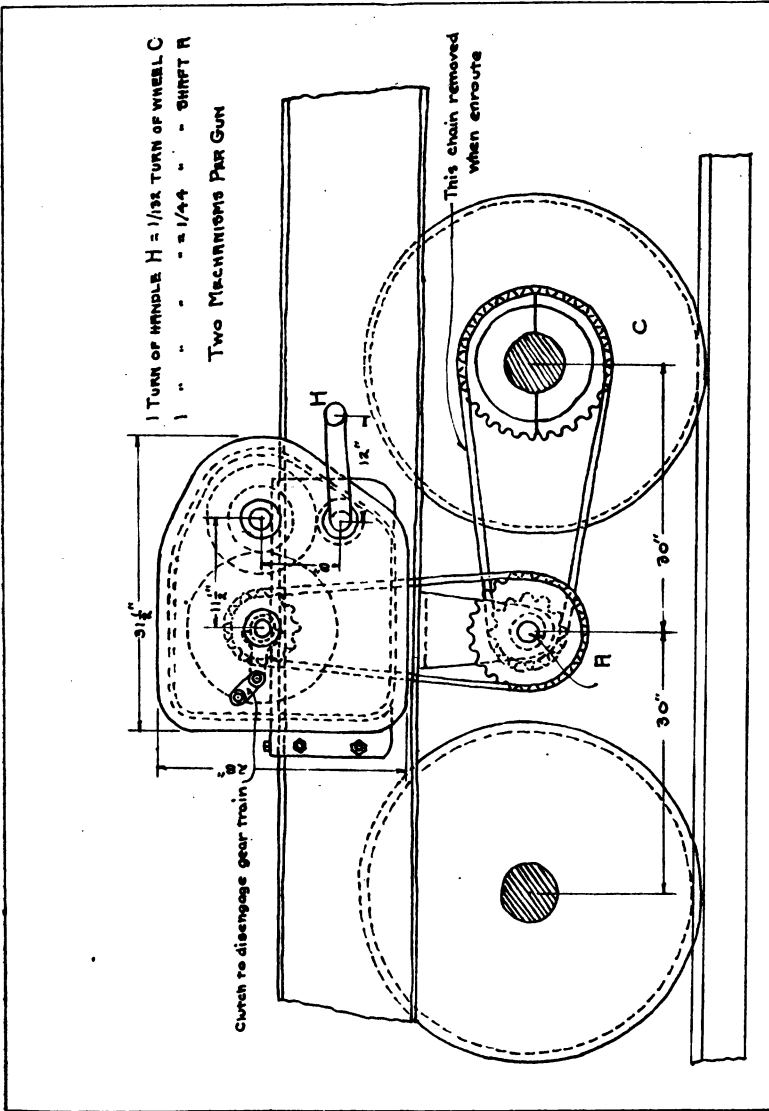

MECHANISM FOR TRANSLATING RAILWAY MOUNT OF SLIDING TYPE TO OBTAIN CORRECT AZIMUTH ON CURVED TRACK.

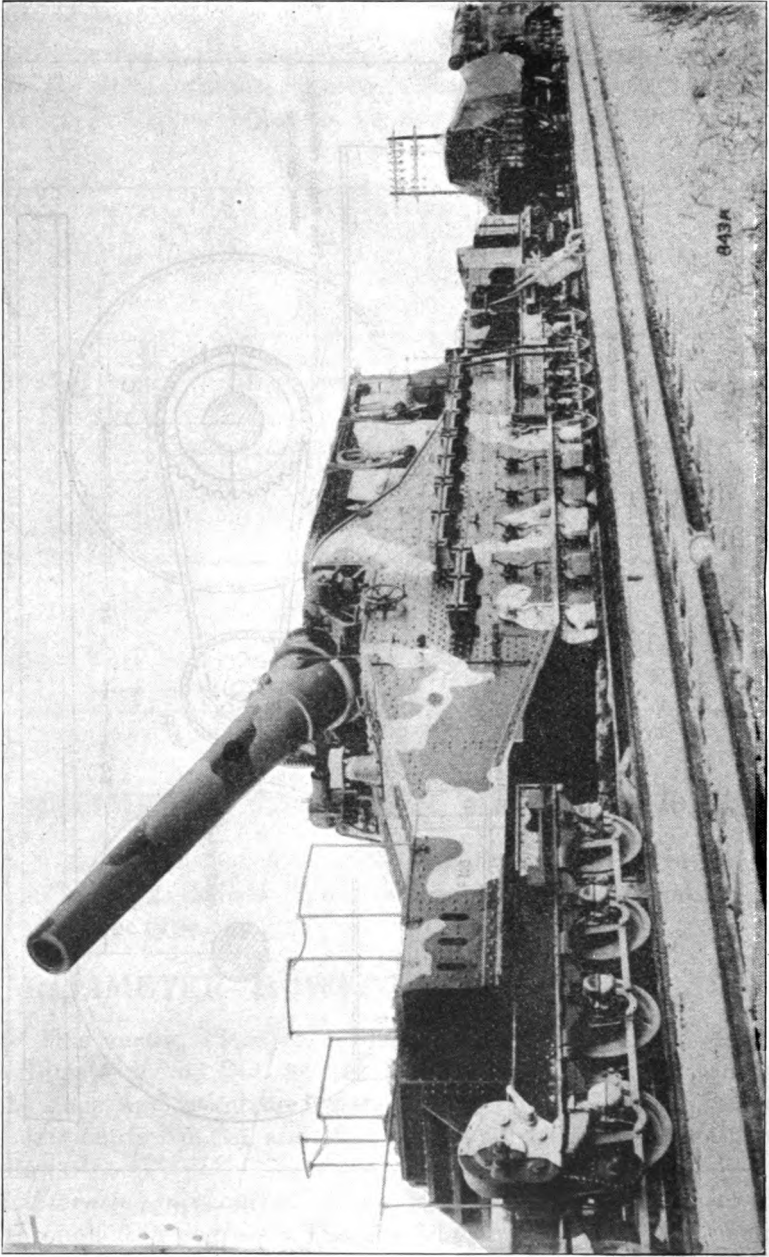

SLIDING TYPE RAILWAY MOUNT FOR 320-MM. HOWITZER MODEL 1881-1884.

340-MILLIMETER GUN, MODEL 1893.

168. This mount, Plate 79, is similar to the above and to mount No. 30. The gun is 35 calibers in length, is made up of a steel tube

PLATE 79

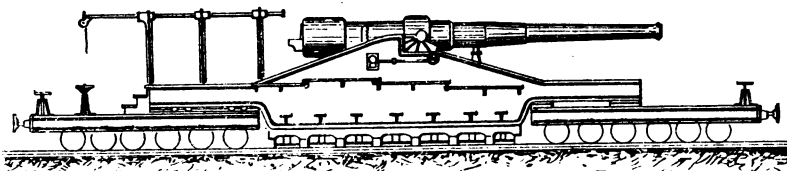

340-MM. GUN, MODEL 1893, ON SLIDING TYPE RAILWAY MOUNT.

and reinforcing hoops, and is fitted with a breech mechanism of the interrupted screw type with percussion firing mechanism.

340-MILLIMETER GUN, MODEL 1912, ON ST. CHAMOND MOUNT.

169. This mount, Plates 80–81a, is unique, and like the 274.4-millimeter sliding mount, No. 23, and the 305-millimeter Batignolles mount, No. 27, represents a distinct type, the distinguishing feature being the system of anchorage, as is the case with the other two types mentioned above. There are no other features which are either unique or unusual, hence in this description most of the attention will be given to the distinguishing characteristic. A number of these mounts were operated by American personnel, and they were considered among the most valuable guns and mounts in the French collection. The extremely heavy and well-camouflaged emplacement at Pont-a-Mousson, Plates 454–456, Volume I, was made for one of these mounts which was operated during the St. Mihiel offensive against the railways leading out of Metz.

170. *Gun.*—This is probably the finest large gun in the possession of the French Army during the war. It is a marine piece of 45 calibers length, is fitted with a slotted or interrupted screw breech mechanism which is operated by the continuous motion of a single crank and is adapted for either percussion or electric firing. Its range is 33 kilometers with a projectile weighing 940 pounds. It was one of these guns that was experimentally converted into a 21-centimeter 100-caliber gun in 1918–19 for extreme range service. In placing the gun so far forward in order to secure the desired elevation for the maximum range it was necessary to provide it with a very heavy counterweight to balance the muzzle preponderance. The pistons of the recoil and recuperator cylinders are attached to this counterweight, Plate 81a, upper view.

171. *Recoil mechanism.*—The gun is carried in a cradle that is swung by its trunnions in bearings mounted directly on the side girders of the carriage. There are four relatively short hydraulic cylinders mounted symmetrically about the cradle and one pneumatic recuperator cylinder in the center at the bottom.

PLATE 80

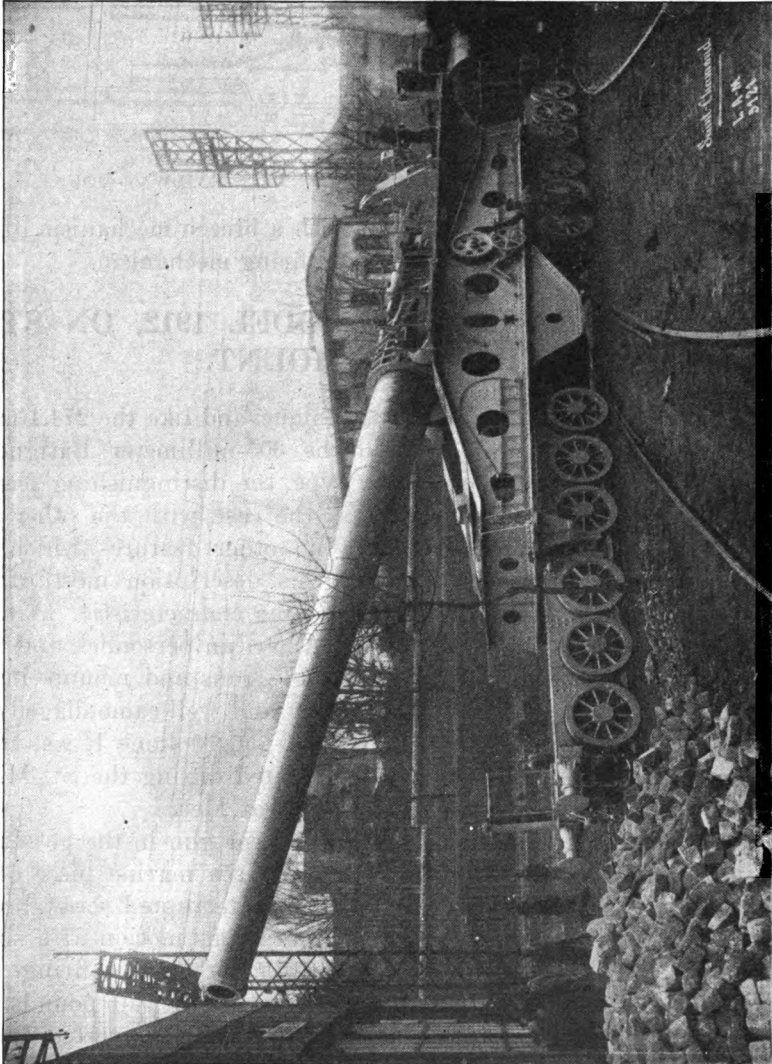

340-MM. GUN, MODEL 1912, ON ST. CHAMOND RAILWAY MOUNT.

172. *Elevating mechanism.*—As discussed in paragraph 420, Volume I, this elevating mechanism is of a type and has the ratio of gun to handwheel movement that experience seems to have proved the best. The single elevating rack is bolted to the left side of the cradle, and a train of spur gears leads to the handwheel seen on the left side

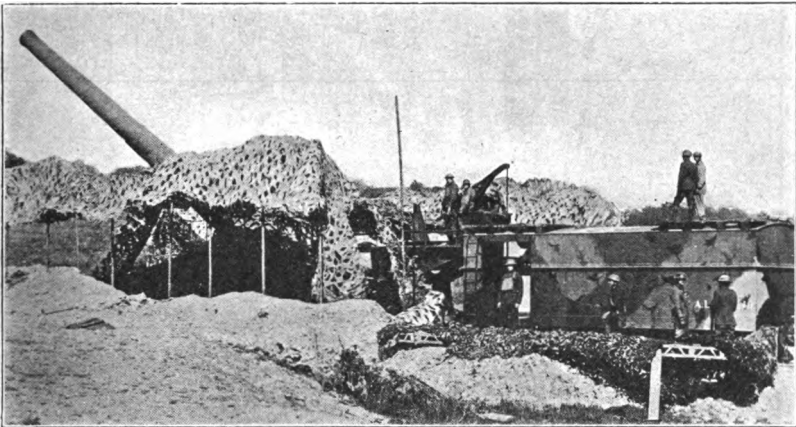

340-MM. GUN, MODEL 1912, IN ACTION WITH AMERICAN CREW.

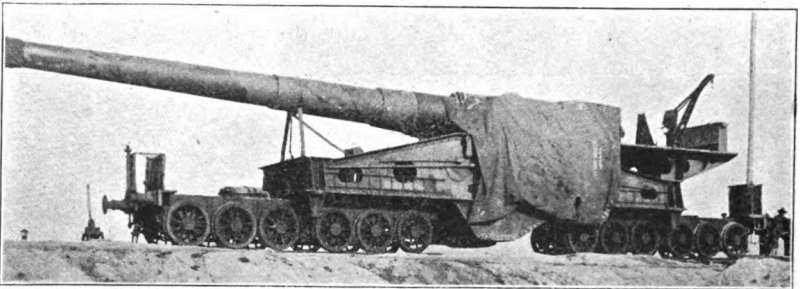
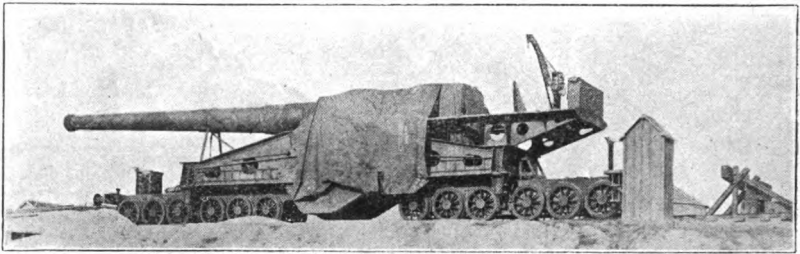
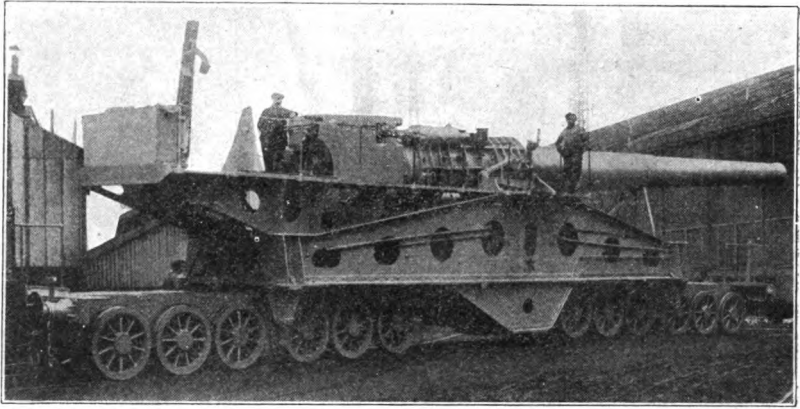

340-MM. GUN, MODEL 1912, ON ST. CHAMOND RAILWAY MOUNT, IN TRAVELING POSITION.

near the bottom chord of the side girder, Plate 80. The ratio of gun to handwheel movement is 1 degree to 1 turn.

173. *Traversing mechanism.*—Inasmuch as the discussion of the traversing mechanism of this mount is so closely allied with a discussion of the system of anchorage it will be given under that heading.

174. *Railway car body.*—The railway car body, Plate 80, is composed of two structural steel side girders joined by two ordinary transoms at the end and one extremely heavy transom in the center. Cast-steel trunnion bearings are mounted on the top and an addi-

PLATE 82

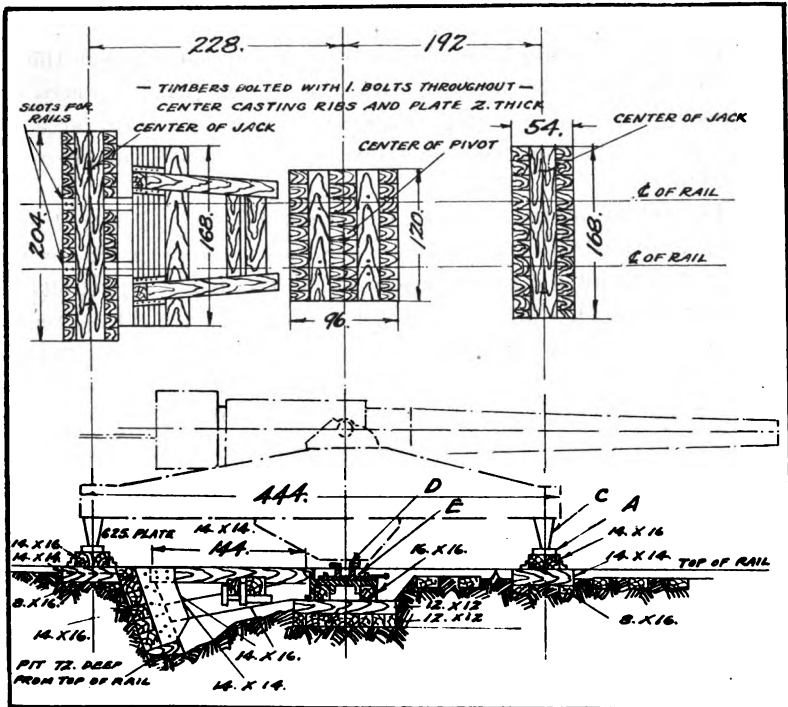

PLAN AND SIDE ELEVATION OF EMPLACEMENT FOR ST. CHAMOND RAILWAY MOUNT WITH 340 GUN, MODEL 1912.

tional platform of lighter construction is built on the car body at the rear. The large heavy transom in the center serves not only to connect and brace the side girders, but likewise has built into it a large steel casting which carries the heavy steel pintle. The construction is necessarily quite heavy, since this pintle must take the full horizontal component of the force of recoil.

175. *Anchorage.*—The firing platform equipment provided for this mount is more elaborate than that provided for any other mount in the French Army. On Plates 82 to 84, inclusive, are given sketches of the assembly and details of this firing platform with indications

of their construction. The platform complete weighs 35 tons and from two to five days is required for its installation. Some conception of the size of the parts of this platform will be gotten from Plates 85 and 86. It is understood that under the most favorable conditions an American battery was able to install one of these platforms in one and one-half days. It is not probable that such favorable conditions would ever be encountered at the front. A rolling bridge identical with that shown on Plates 85-86 is required to handle all of the parts. It will be noted that considerable excavation is necessary and all of the elements of the platform must be placed most carefully. After the firing platform is in place the procedure is as follows:

176. The gun is brought by locomotive into position over the emplacement. It must be located with the center pivot exactly over the recess in the center casing, Plate 82. The two transverse timbers, A and B, Plate 82, on the front and rear platform are not in place at this time.

177. The whole mount (except the trucks) is raised 6 or 7 centimeters by four hydraulic jacks set at the four corners under the rests C, Plate 82, and on the base section of the front and rear platform. The center pivot D, Plate 82, is then turned through 60 degrees (it has three lugs or an interrupted collar on it, matching recesses in the sleeve in which it slides), and is dropped down into the seat in the center casting recess E, the movement being controlled by a chain block. The pivot is then turned 60 degrees backward to lock it down (by means of the interrupted collar). The center pins of the trucks are then raised (they also have interrupted collars), and the trucks are run out, front and rear.

178. Two pieces of 4 by 4 timber are then placed on end between the base section of the rear platform and car body. These take a 2-ton load only, since the mount balances at the center, except for a 2-ton greater load at the rear end. The hydraulic jacks are then let down and removed, leaving the mount resting on the center pin and the two pieces of timber at the rear. The transverse timbers A, Figure 2, Plates 82 and 83, are then hauled into place by a crew of seven men. They are handled easily by this force. As noted on Plate 83, the tops of these transverse timbers are covered by heavy plates of steel and the surface of the plates is well greased. The four jackscrews at the corners of the mount are then run down, resting in socket blocks, which in turn rest on the sheet of steel. The gun is leveled with these jacks, but only about one-half of the weight of the mount is carried by them. For traversing, a piece of steel about 2 inches in diameter is run vertically through two eyes cast in the side of the left-hand rear jackscrew case. This piece of steel has a heavy

threaded hole near the bottom and into this hole fits a horizontal rod, screw threaded, and provided with collar and handwheel at the other end. This horizontal rod extends outward at right angles to

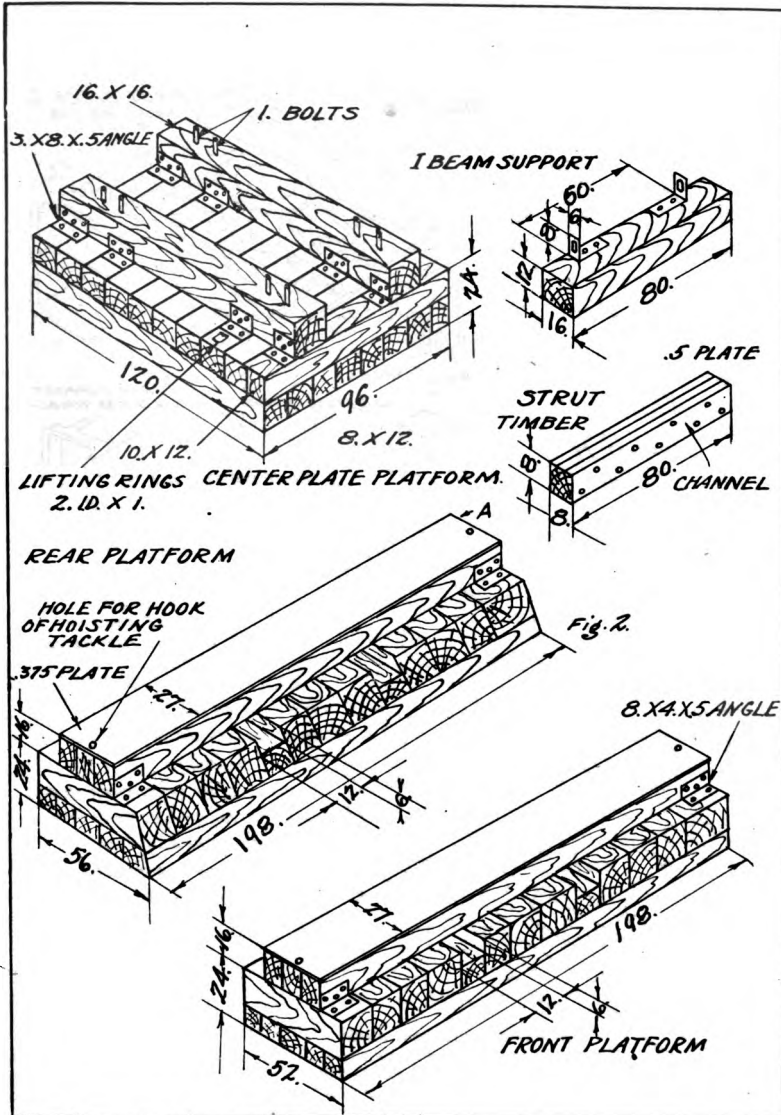

340 GUN, MODEL 1912, MOUNT EMPLACEMENT DETAILS (SEE PL. 82).

the tracks and fits into a yoked rod standing vertically at the end of the rear platform transverse timbers. When the handwheel is turned the screw either pushes or pulls the rear end of the car to

the right or left. A small carriage is swung from the rear of the car and wheels on this carriage provide a rolling movement of the rear of the car body. Ordinarily this carriage is not used. The

PLATE 84

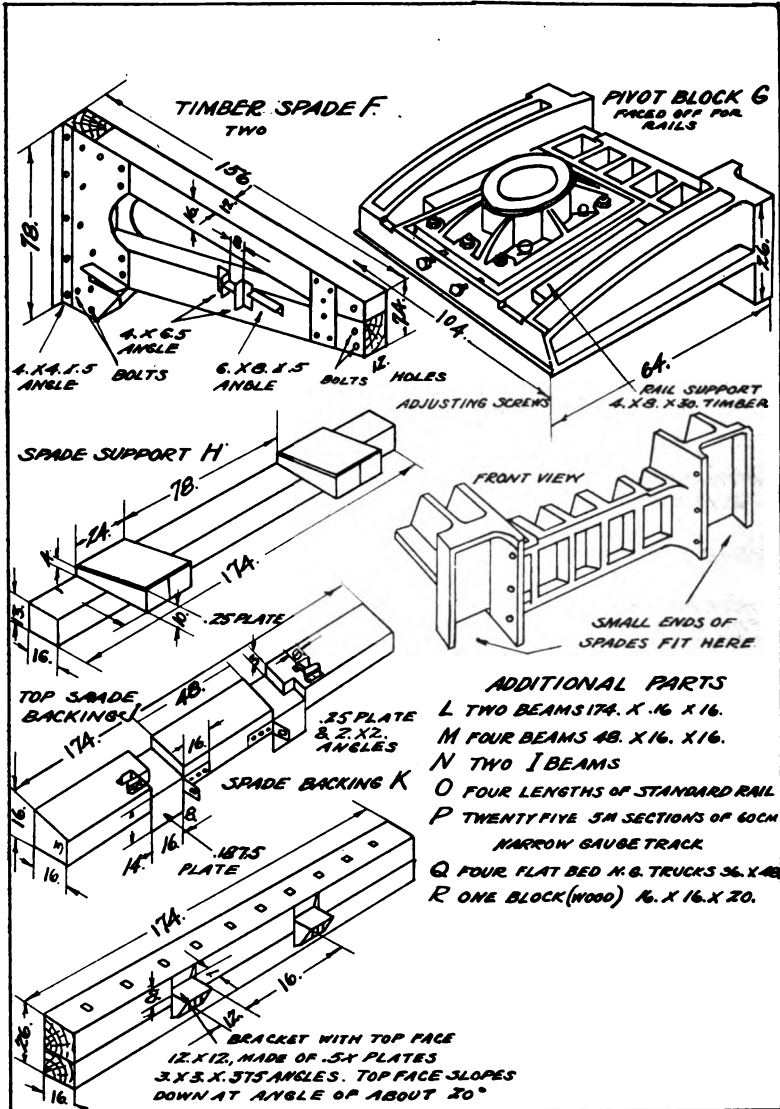

EMPLACEMENT DETAILS (SEE PL. 82).

socket blocks under the jackscrews slide very easily on the greased steel plates mounted on the transverse timbers, and the force required to traverse the mount is not very great.

179. After the firing platform has been carefully placed, from 30 to 60 minutes are required to place the mount and prepare it for action. The battery commander reports that more time is ordinarily required to remove the mount than to place it. This is to a large extent due to the fact that the center pin is likely to bind and be very difficult to remove. Ordinarily from the time of firing the last shot until the time of coupling the locomotive to the carriage there elapses a period of about one hour. At practice the best time that has ever been made in removing the mount was 25 minutes. This was under the most favorable conditions imaginable and with a thoroughly trained crew. Such speed as this could not be made in the field.

180. *Trucks.*—There is nothing unusual in the design of these trucks. Attention is called to the fact that the journals of these axles are on the inside of the wheels and as a consequence the journal bearings are most difficult to replace. Attention is called to the fact, also, that the brake operates on only the center two pairs of wheels.

181. *Ammunition supply system.*—A crane, Plate 81, is provided on the rear of the loading platform for raising the shell onto the tray and from there to the shot truck. A shot truck of the ordinary type is provided. It is understood that four men are ordinarily required to run the projectile.

182. *Maintenance.*—The battery commanders who have handled these guns as well as the officers in charge of the repair shops report that the bulk of the maintenance has been on the firing platforms. When the mount itself is handled with care there is little likelihood of any breakage or of the mount being damaged. There seems some possibility of breaking the pintle housing and the pintle itself being badly strained unless the mount is handled with care. So far this has not happened, however. Because of the long time required to remove the firing platform many of them have been damaged and some partly or wholly destroyed by enemy shell fire.

183. *Difficulties involved in the service.*—The most serious difficulty is the placing of the firing platform, requiring from two to five days. A second serious difficulty is the removing of the firing platform, requiring a minimum of two days. Two other difficulties are the placing and removing of the mount. Considerable difficulty is sometimes experienced in so placing the mount that the pintle will drop into the socket in the heavy plate mounted on the firing platform. Considerable difficulty is likewise experienced in removing the mount, inasmuch as the pintle may bind severely in the socket.

PLATE 85

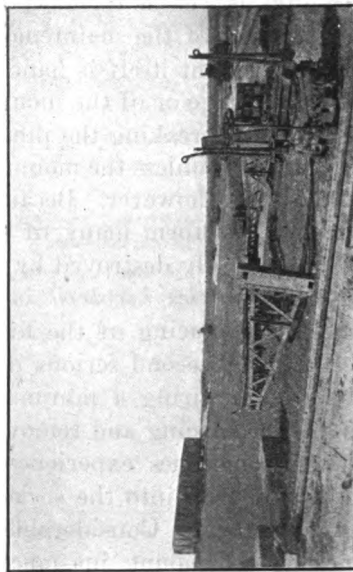
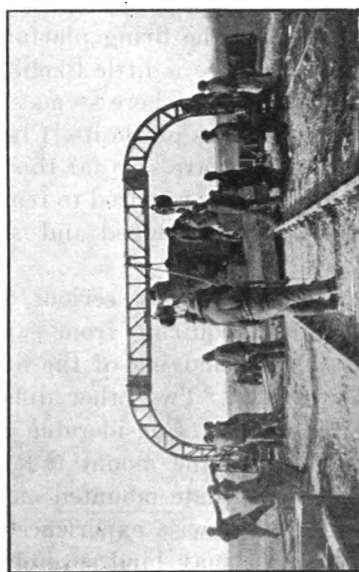
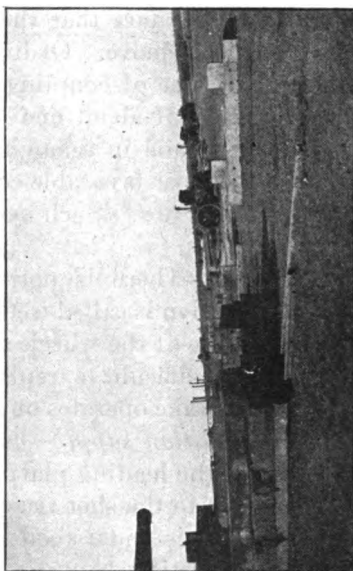
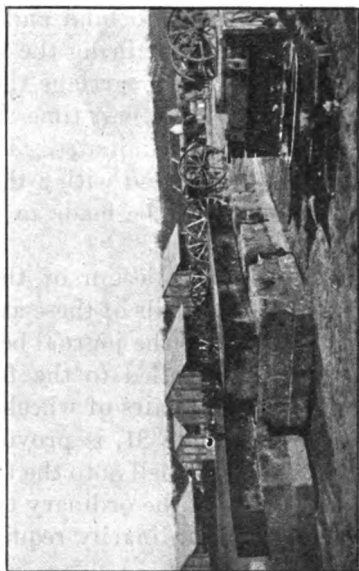

EMPLACEMENT MATÉRIEL AND EQUIPMENT FOR THE 340-MM GUN, MODEL 1912, RAILWAY MOUNT.

PLATE 86

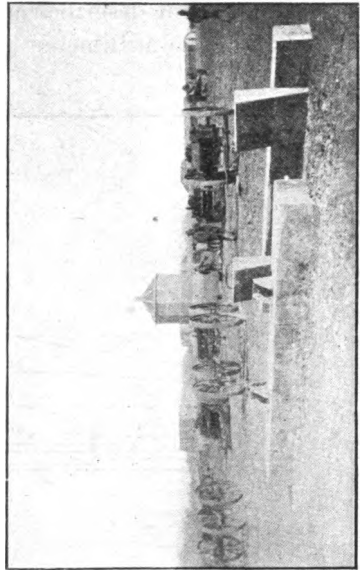
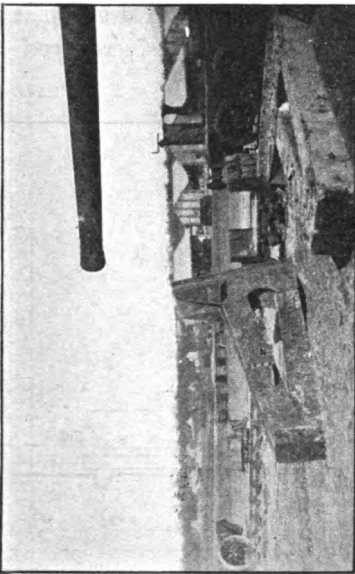
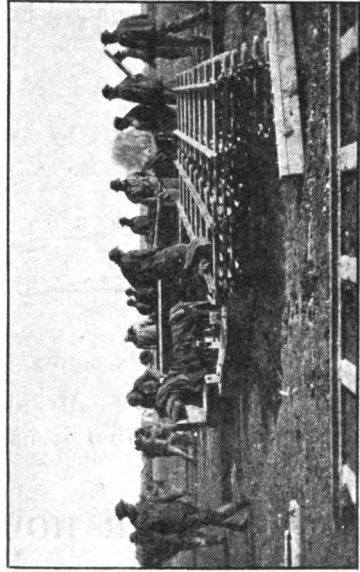
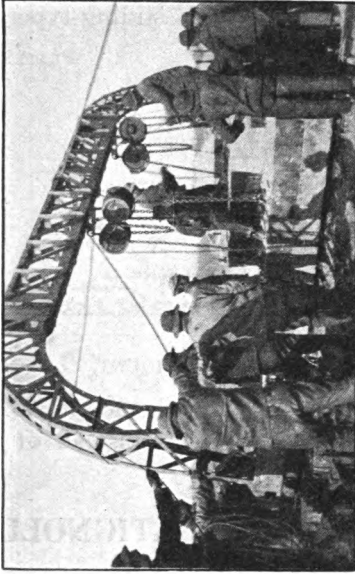

SCENES INCIDENT TO INSTALLING EMPACEMENT FOR 340 GUN RAILWAY MOUNT.

340-MILLIMETER GUN, MODEL 1912, ON SLIDING-TYPE MOUNT.

184. This is the same gun as the preceding, without any cradle or recoil mechanism, however, and mounted on a sliding-type car-

PLATE 87

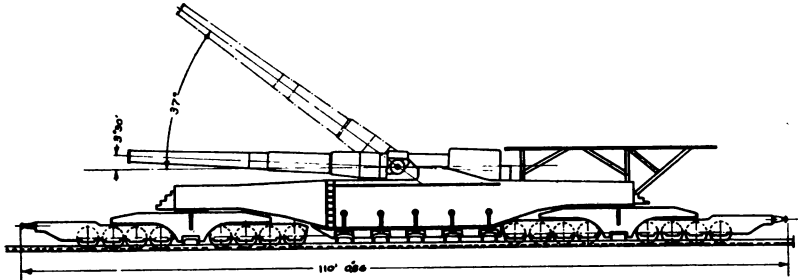

340-MM. GUN, MODEL 1912, ON SLIDING TYPE MOUNT.

riage, Plate 87, practically identical in design with mount No. 34, with the exception that it has four 8-wheel trucks instead of two 12-wheel.

370-MILLIMETER HOWITZER, ON BATIGNOLLES MOUNT.

185. This mount, Plates 88-94, is identical in design with the Batignolles mount described under No. 27. The gun used on it was originally a 305-millimeter naval gun, Model 1887, rebored and

PLATE 88

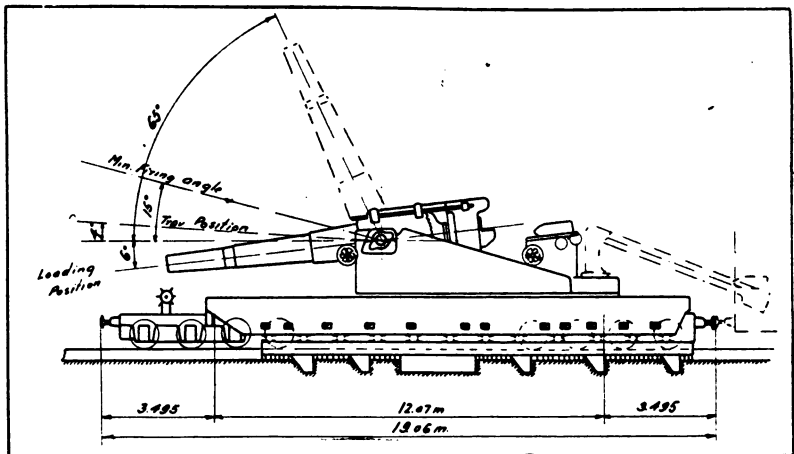

370-MM. HOWITZER, ON SLIDING MOUNT (BATIGNOLLES).

shortened slightly. As a howitzer it has a range of only 16.5 kilometers, as against the 27 kilometers that it had as a 305-millimeter gun.

PLATE 89

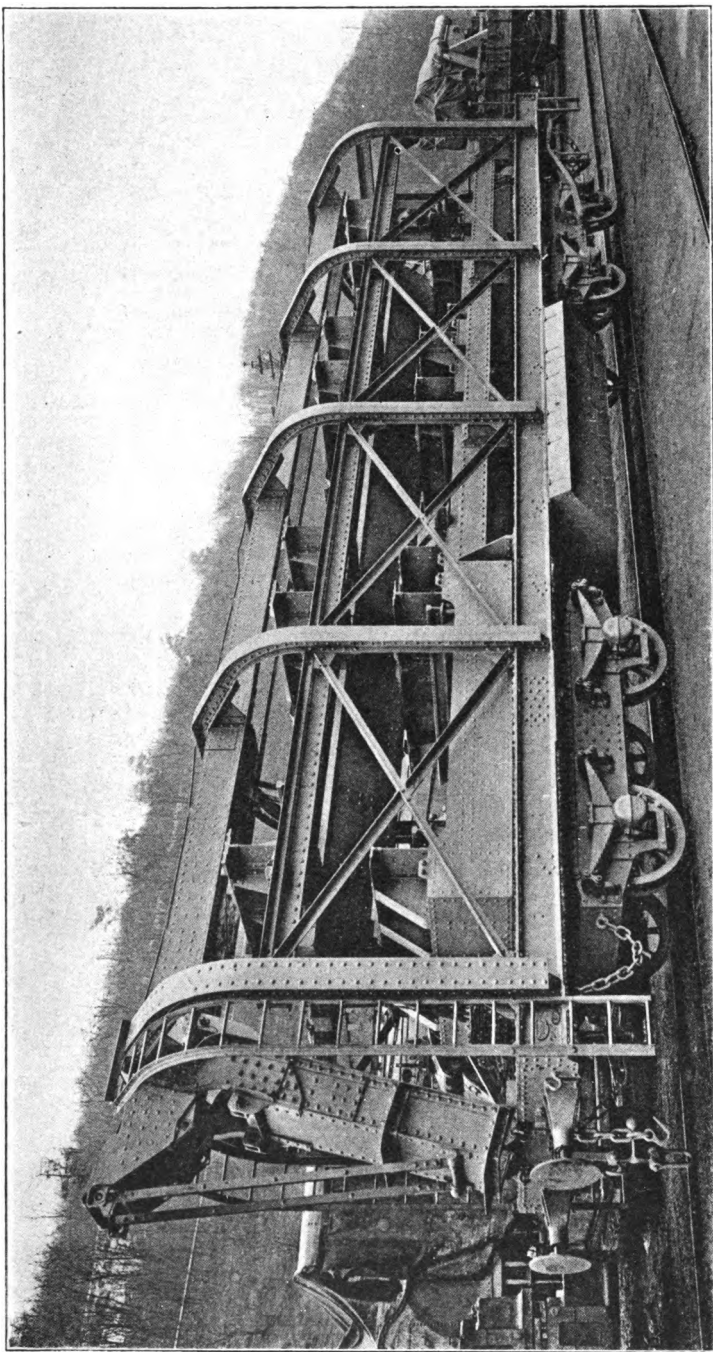

SPECIAL CAR FOR LOADING AND TRANSPORTING FIRING PLATFORM OF THE BATIGNOLLES TYPE MOUNT.

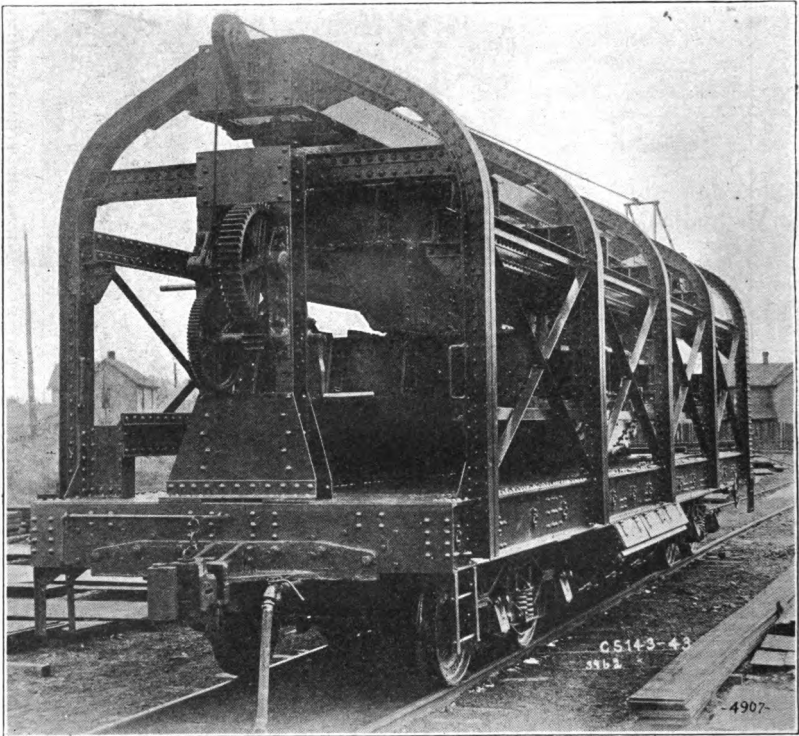

CRANE GEARING ON FIRING PLATFORM CAR.

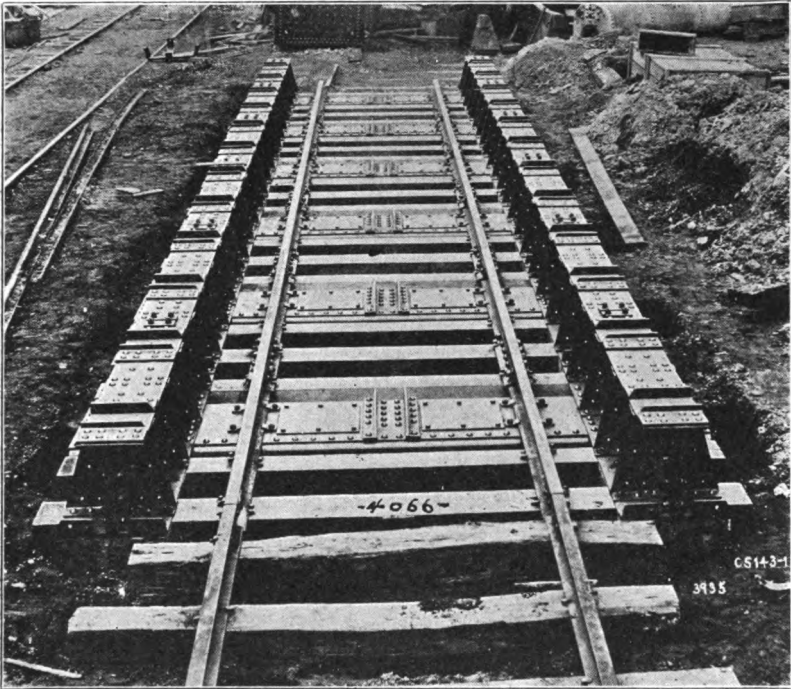

APPROACH VIEW OF FIRING PLATFORM.

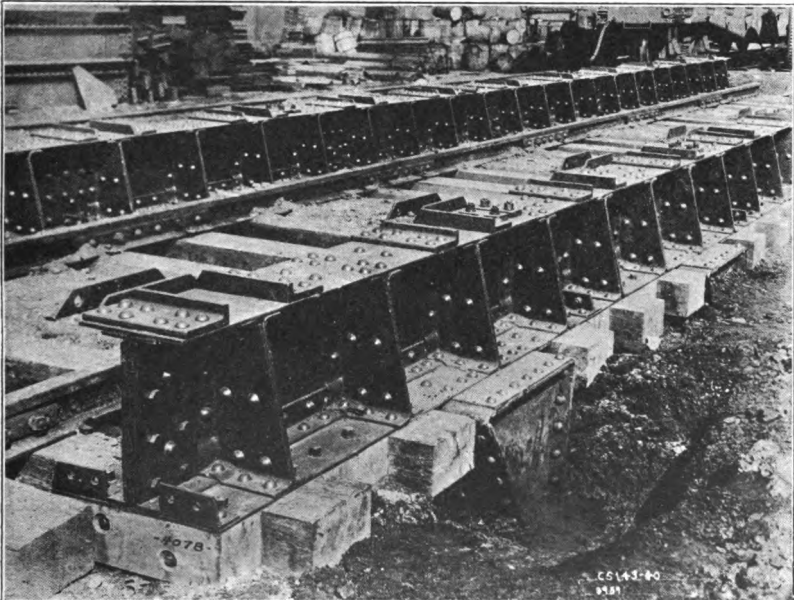

CROSS TRACK VIEW OF FIRING PLATFORM.

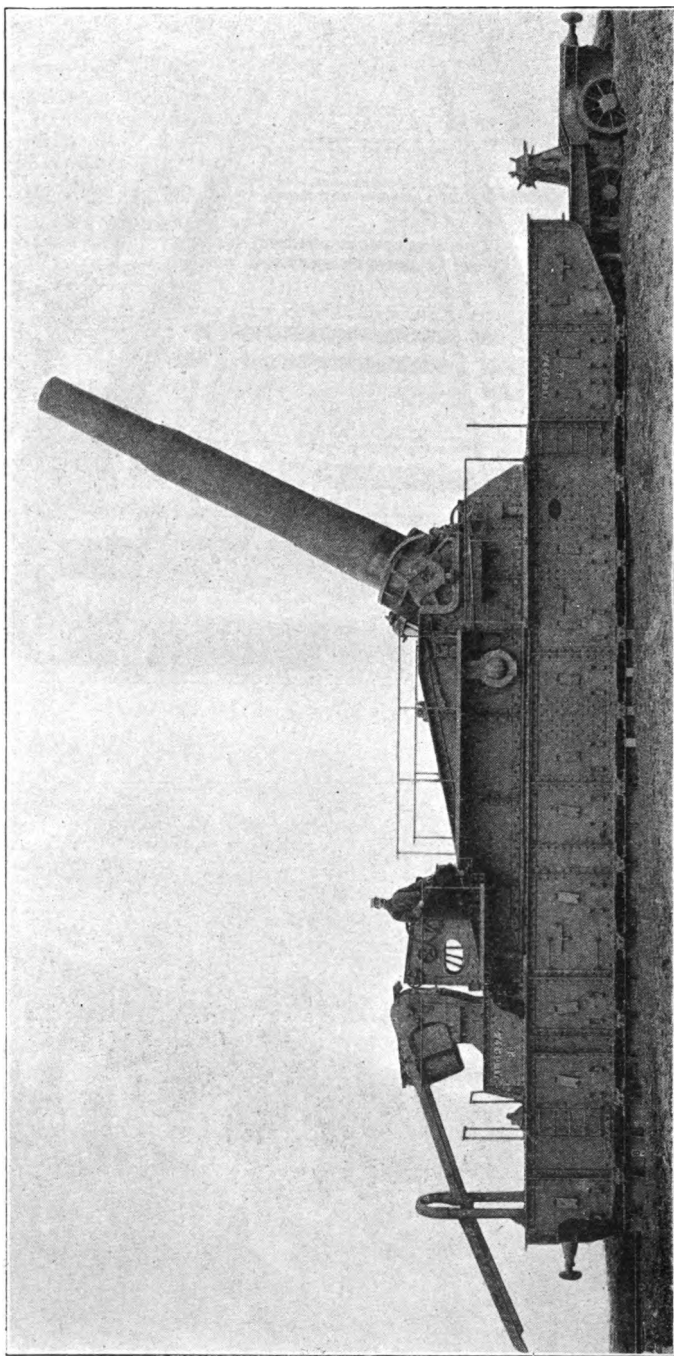

BATAILLON TYPE RAILWAY MOUNT IN BATTERY, MOUNTING 370-MM. HOWITZER.

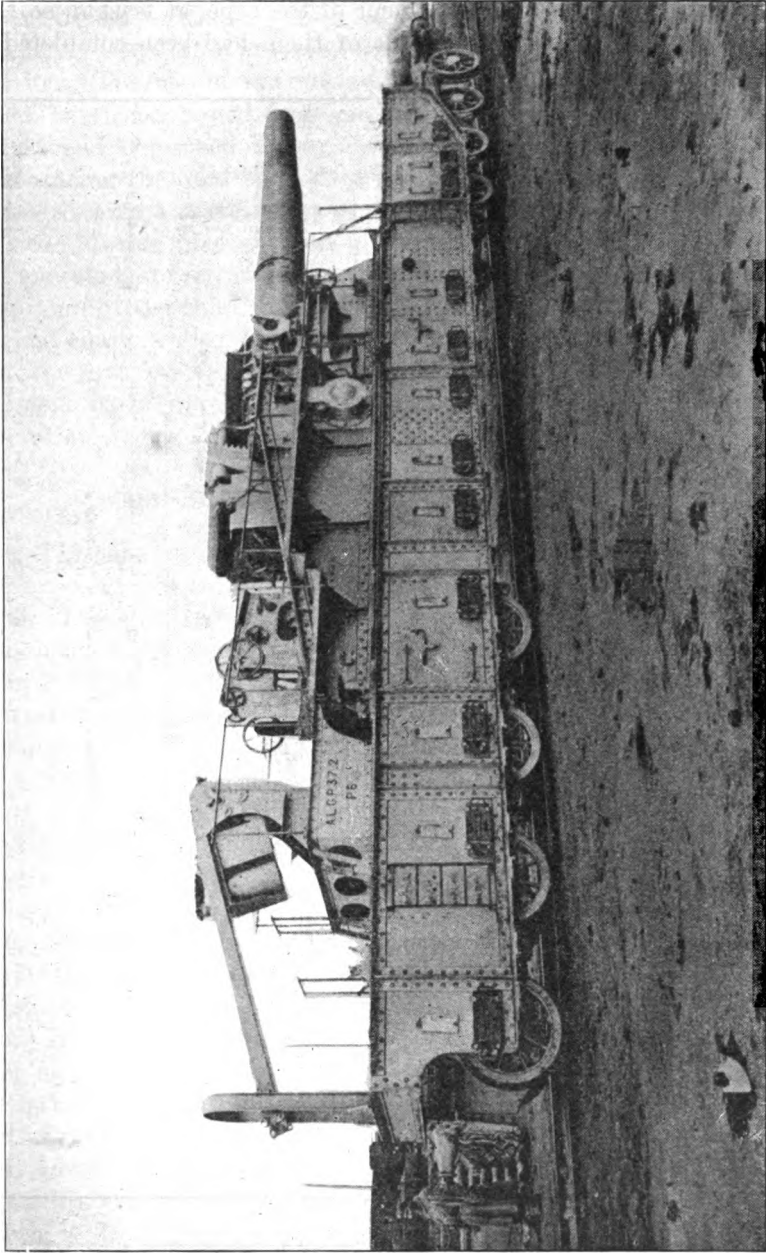

370-MM. HOWITZER BATAILLONLES MOUNT IN TRAVELING POSITION.

370-MILLIMETER HOWITZER, MODEL 1875, 1879.

186. This mount, Plate 95, is of the Schneider sliding type but represents the highest development of the type, at least in so far as its operation is concerned. None of them had been completed and

PLATE 95

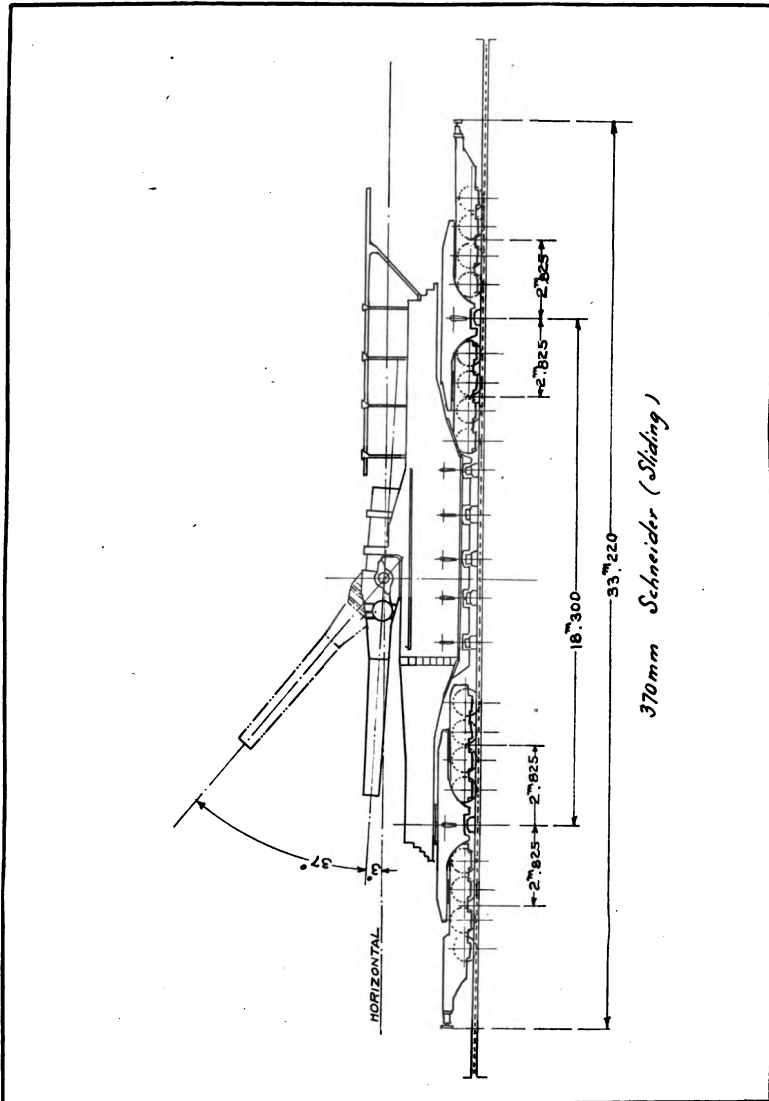

put into service before the cessation of hostilities. A number were in process of manufacture to be used with both 340 and 370 millimeter howitzers in the shops at St. Nazaire as well as at Bordeaux

and the writer had the opportunity to examine one finished mount that had been tried out at the proving ground.

187. It seems that the designers had patterned this mount to a certain extent after the 520-millimeter mount which had been finished for nearly a year. It is provided with electric power for nearly every operation. The mount is translated electrically, the ammunition is hoisted, carried forward, and rammed electrically, and the gun is elevated and depressed by an electric motor. Observation of the mount during the final process of erection gives one the impression that he is seeing a traveling power station. There are control boxes in all conceivable places. And in the summer of 1919 after one of these mounts had been given its tryout at the proving ground it was the opinion of the chief designer that there was decidedly too much electrical equipment on it. Most of it went out of order with the firing of the first few shots, presumably because the fastenings and the equipment itself were not sufficiently sturdy to stand the extreme acceleration of the mount on firing.

400-MILLIMETER HOWITZER.

188. This mount, Plates 96-102a, is of the cradle-recoil, top-carriage type and is in general similar to the 340-millimeter mount No. 35. The gun is a rebored 340-millimeter naval gun, Model 1887, and is provided with an interrupted screw breech mechanism of the system Farcot.

189. *Recoil mechanism.*—As with the 340-millimeter gun on St. Chamond mount this howitzer is carried in a cradle which in this case, however, is supported on a top carriage which is rotatable with respect to the car body. The cradle is provided with two hydraulic cylinders at the bottom, and one pneumatic recuperator in the center at the top. The normal length of recoil is 0.875 meter or 34.4 inches.

190. *Elevating mechanism.*—This mechanism comprises simply a train of spur gears, the rack being bolted to the right instead of the left side of the cradle as has been the case with so many of the guns already described. These gears, pinions, and shafts lead to the hand-wheel on the right-hand side of the top carriage, Plate 97. The ratio is 1.5 degrees of elevation per turn of the handwheel.

191. *Traversing mechanism.*—The traversing mechanism is practically identical with that provided on the 305 and 370 millimeter Batignolles mounts, Nos. 27 and 37. The gun carriage rotates about a pintle located at its forward end. To the rear of the carriage is attached a short rack into which a pinion meshes, the shaft of which is seen just in front of the ammunition table. This mechanism gives a traverse of 5 degrees on each side of the center. It will be noted

that the vertical shaft of the pinion which meshes with the traversing rack is not provided with a handle. A solid wrench is provided by means of which the gun carriage may be traversed very slowly, the handle having a movement of 180 degrees without being

PLATE 96

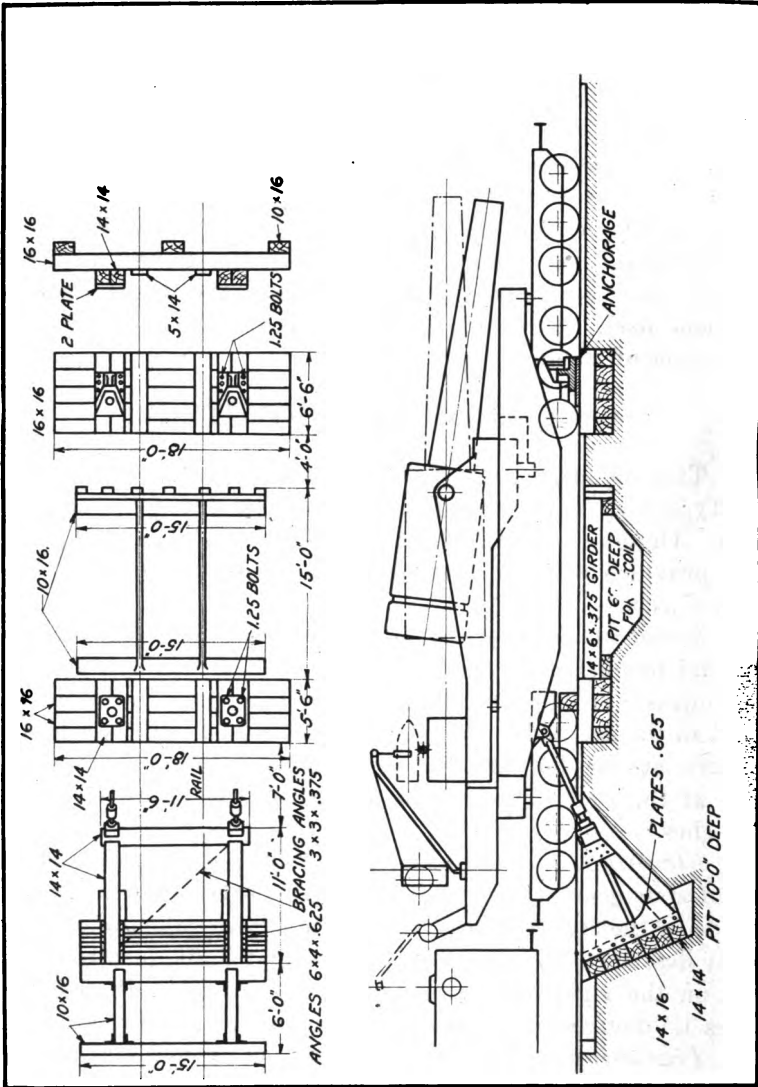

400-MM. HOWITZER ON ST. CHAMOND MOUNT AND EMPLACEMENT.

removed and replaced. This is no disadvantage inasmuch as the traversing mechanism is provided almost solely for the correction of fire.

192. *Gun carriage.*—As is the case with the traversing mechanism, the construction of the gun carriage is likewise very similar to the

PLATE 96A

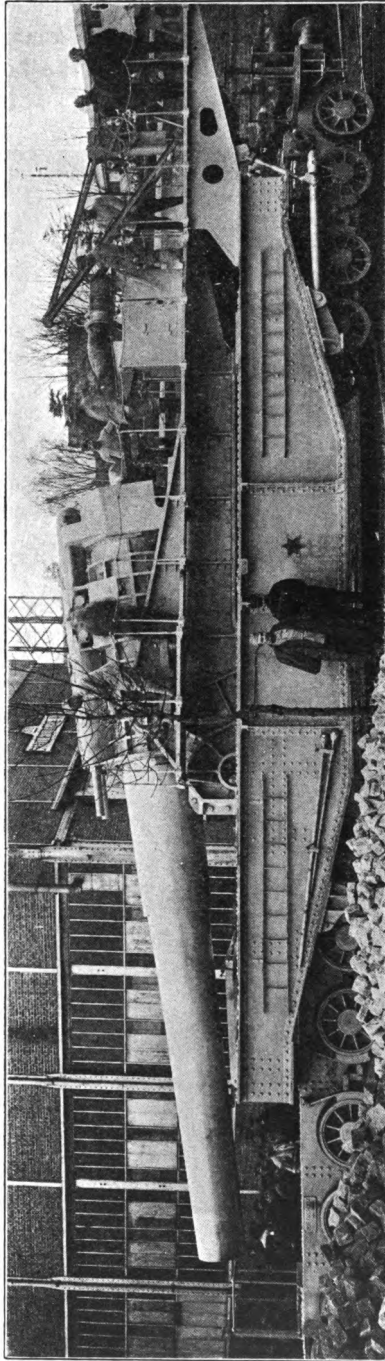

400-MM. HOWITZER ON RAILWAY MOUNT. HOWITZER SHOWN IN LOADING POSITION, 8° MUZZLE DEPRESSION.

construction of the carriages of the 305 and 370 Batignolles mounts. The carriage is composed of two heavy cast-steel sides which are joined by suitable transoms at the front and rear. At the front the gun carriage rests over a pintle built into the body of the railway car.

PLATE 97

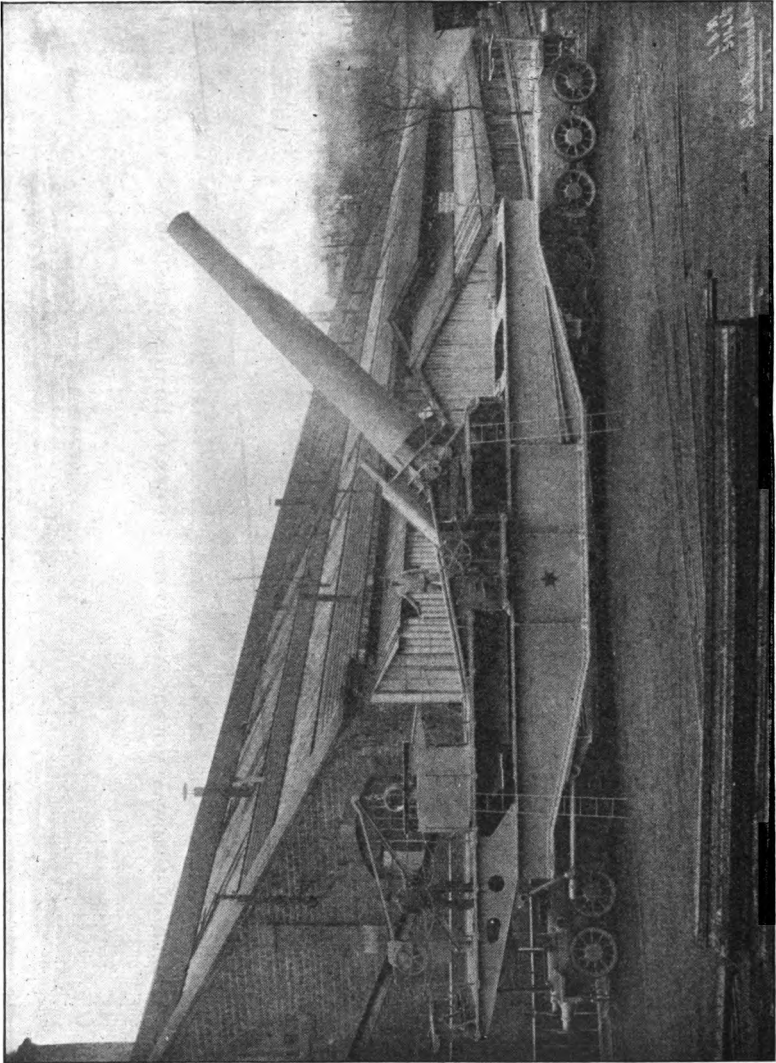

RIGHT ELEVATION ST. CHAMMOND MOUNT WITH 400-MM. HOWITZER.

193. *Railway car body.*—The design of this car body is admirable in its simplicity, but no features are worthy of especial mention. As noted in Plate 97, it is composed of two side girders joined by seven transoms. On the rear is built a loading platform of considerably lighter construction than the car frame.

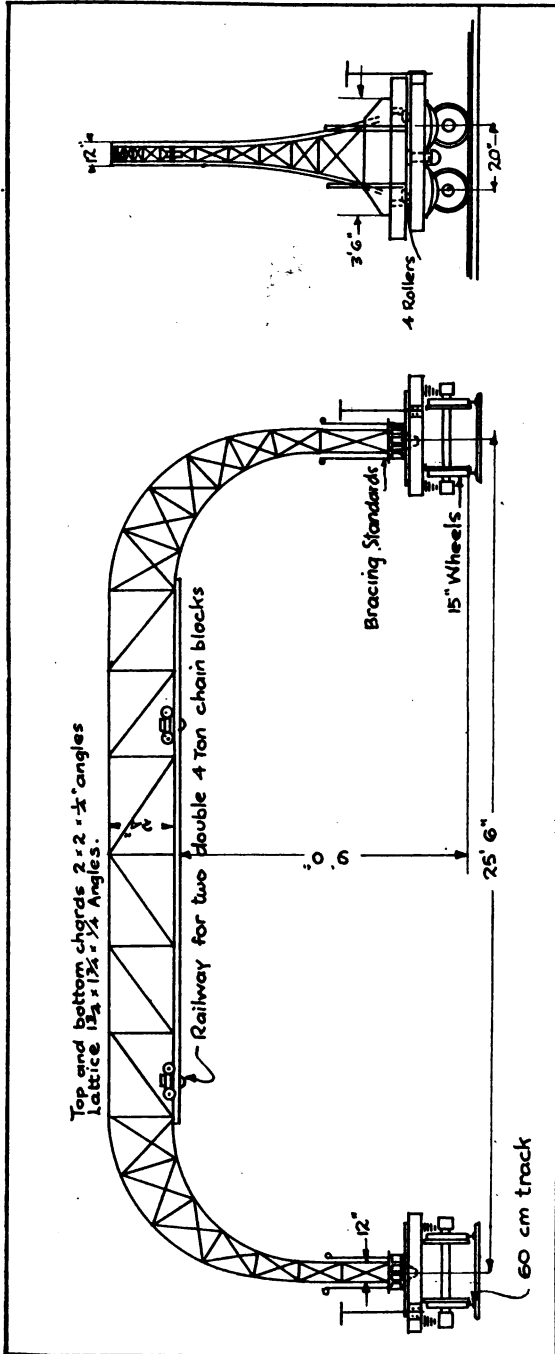

ASSEMBLY DRAWING OF ROLLING BRIDGE USED TO INSTALL FIRING PLATFORM, ETC., OF 400-MM. HOWITZER MOUNT.

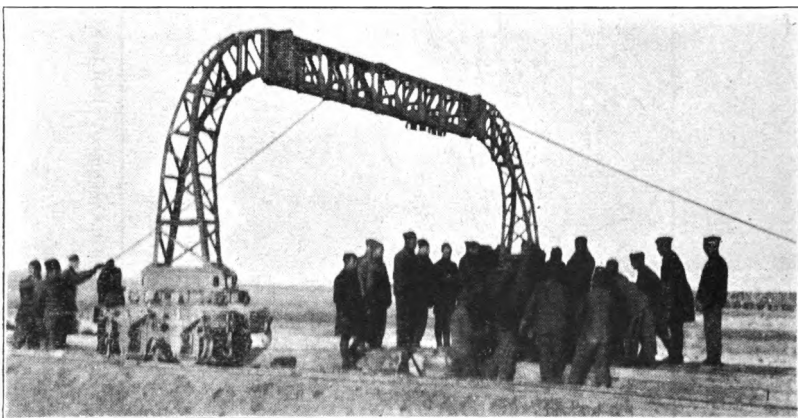
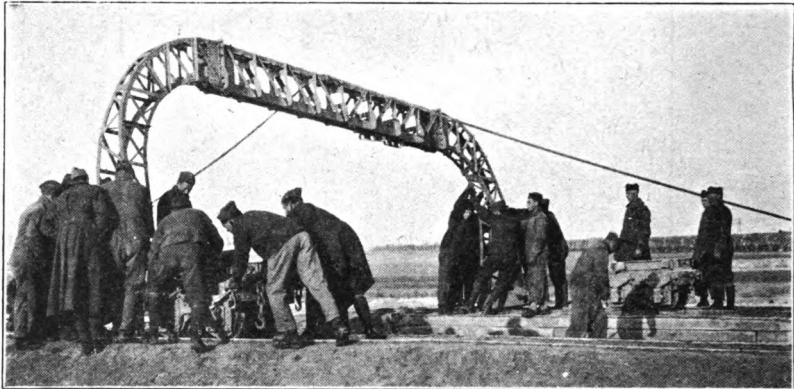

SETTING UP ROLLING BRIDGE.

194. *Anchorage*.—Next to the scheme of anchorage used with the 340-millimeter St. Chamond mount the scheme used for this mount is the most elaborate used in the French Army. In Plate 96 are

PLATE 100

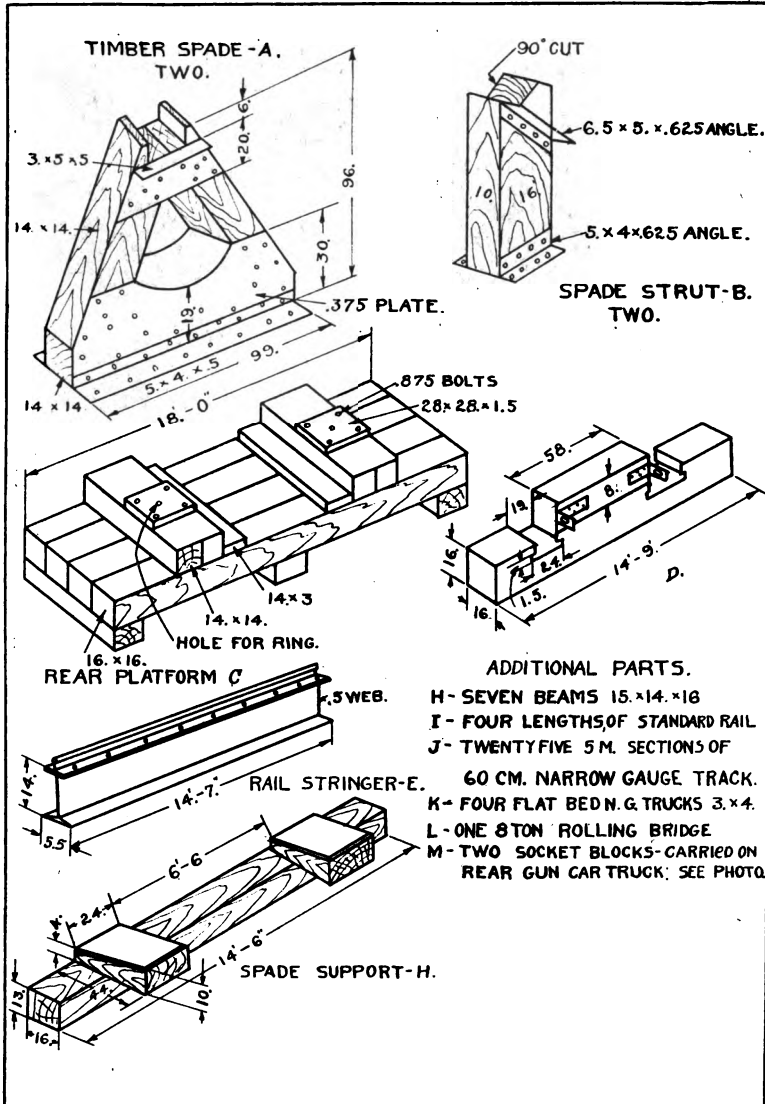

EMPLACEMENT DETAILS OF 400-MM. HOWITZER RAILWAY MOUNT.

shown two views of this firing platform with the mount in firing position. On Plates 100-102 are given sketches and photos of the individual parts composing this firing platform with indications of

PLATE 101

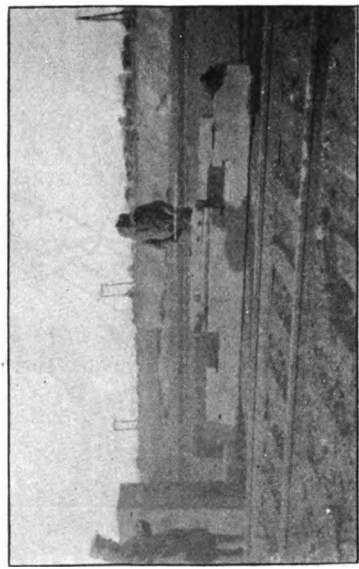
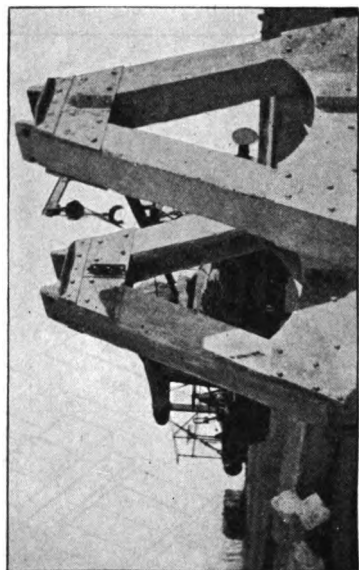
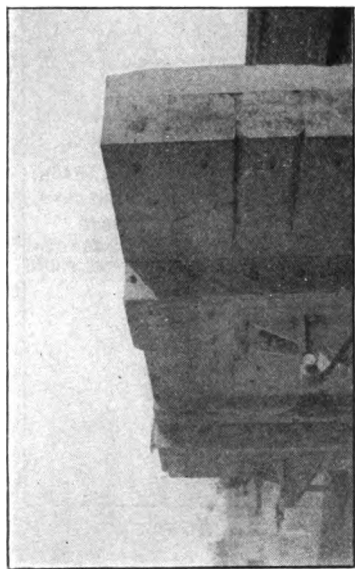
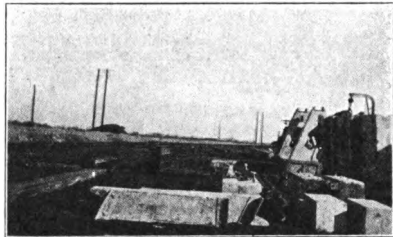
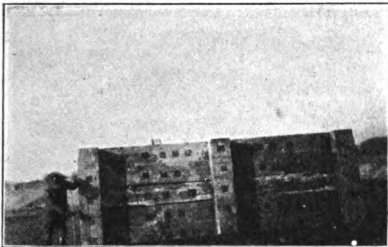
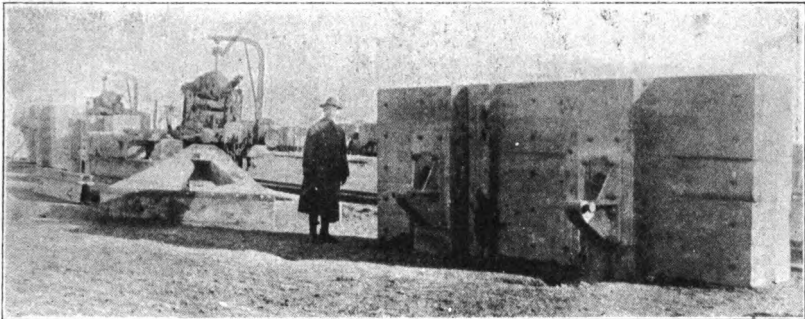

ILLUSTRATION SHOWING MASSIVE PROPORTIONS OF VARIOUS PARTS OF FIRING PLATFORM FOR EMPACEMENT OF THE 400-MM. MOUNT.

their construction. The platform complete weighs 29 tons, and from two to five days are required for its installation. It is understood that an American battery succeeded in installing this platform in less than two days under very favorable conditions. These conditions were much more favorable than could be expected at the front. The rolling bridge shown on Plate 98 is used in the installation of the firing platform. On Plate 100 is given a list of additional parts not shown on the sketches. These parts include four flat-bed narrow-gauge trucks, twenty-five 5-meter sections of narrow-gauge track, a number of heavy beams, several sections of standard railway rail, and two socket blocks which can be seen carried on the

PLATE 101A



HEAVY TIMBERED UNITS OF FIRING PLATFORM.

rear truck on Plate 97. In transit about five flat cars are required to carry this equipment, and before the platform can be installed considerable excavation is necessary. On Plates 101-101b are given photographs showing parts of this firing platform as found at the artillery park where the guns are located when not in action. Some idea of the magnitude of the job of handling such a platform can be gathered from the appearance of these parts.

195. It will be noted on Plate 96 that it is not necessary to remove the trucks from this mount in firing, as is necessary with the 340-millimeter mount. The two struts observed at the rear of the car, communicate with the triangular timber spades. The socket

blocks carried on the rear truck are placed over the timber spades and receive the ball ends of the struts. The forward end of the car is anchored rigidly to the forward platform. Under the center of the car it is necessary to dig a pit 5 feet deep to permit the gun to recoil when operated at its maximum elevation.

196. Although an excessive amount of time is required for the placing of the firing platform, the gun can be placed on the platform and prepared for action in a comparatively short time. Approximately 30 minutes is sufficient time for this operation. There are no

PLATE 101B

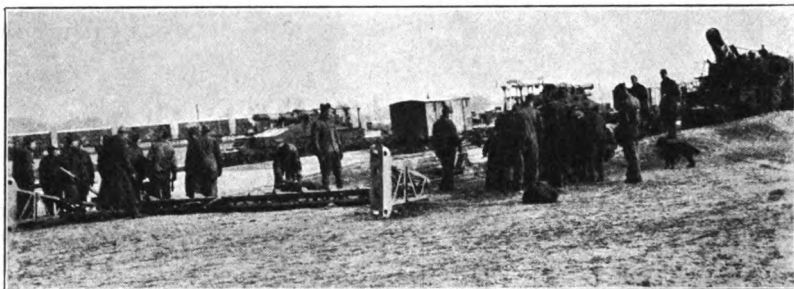

BRIDGE SPAN READY FOR ERECTION.

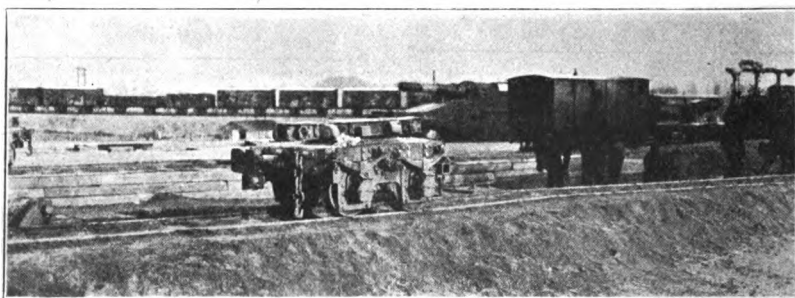

BRIDGE TRUCK ON NARROW GAUGE TRACK.

difficulties in removing the car from the firing position in a very short time. The minimum time for removing the mount in case of emergency from the firing position is approximately 5 minutes. As much time is required to remove the firing platform as is required to remove the platform of the 340-millimeter mount. Two days is the average time.

197. *Trucks.*—There is nothing unusual in the design of the truck. Attention is called to the fact that the journals of these axles are on the inside of these wheels and in consequence the journal bearings are most difficult to replace. It should be noted, likewise, that the front

truck contains six axles and the rear truck four. In each case the brakes operate on the center two pairs of wheels.

198. *Ammunition supply system.*—A pedestal crane is provided on the rear of the loading platform, Plate 96a, for transferring the

PLATE 102

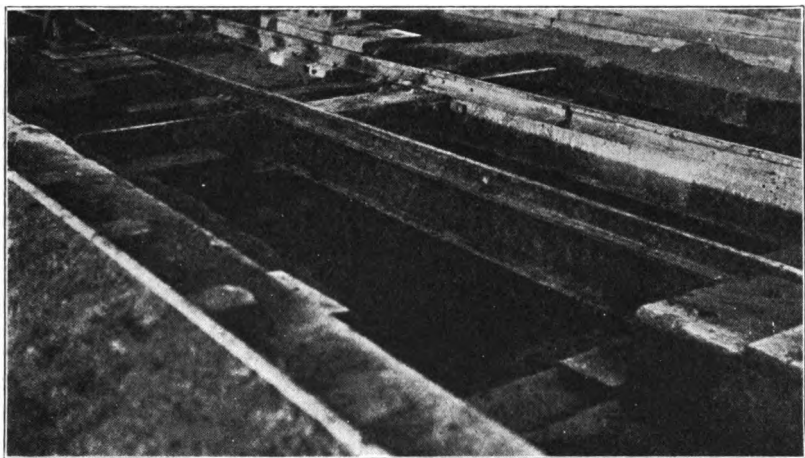
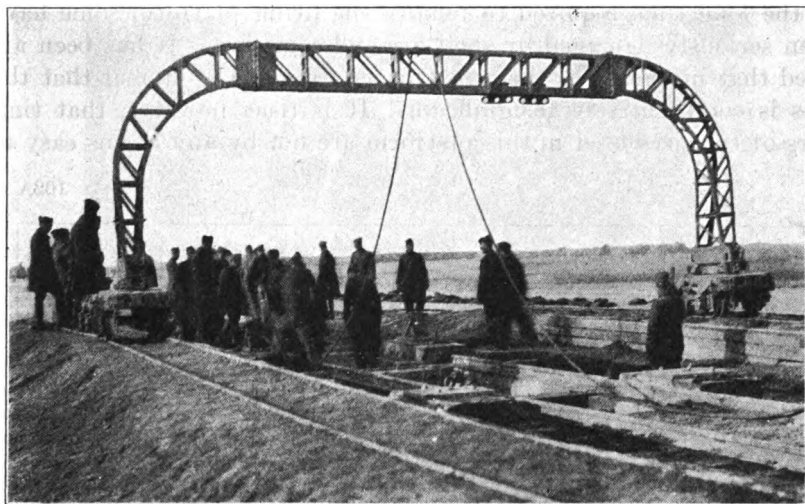

FIRING PLATFORM NEARING COMPLETION.

shells from the ground or ammunition car to the tray on the top of the ammunition table. In loading the gun is depressed 8 degrees and a tray of suitable length is placed between the breech and the front end of the inclined section of the tray on the ammunition table. The hinged tray is tipped forward and the projectile is forced down

the incline and rammed by four men. The powder is provided in quarter charges.

199. *Maintenance.*—All that has been said with reference to the maintenance of the 340-millimeter St. Chamond applies to this mount. The battery commanders report that practically all of the maintenance to date has been on the timber-firing platform. Because of the long time required to remove the firing platform some have been seriously damaged by shell fire and some lost. It has been argued that inasmuch as these platforms are made of timber that the loss is comparatively insignificant. It is true, however, that timbers of the sizes used in this platform are not by any means easy to

PLATE 102A

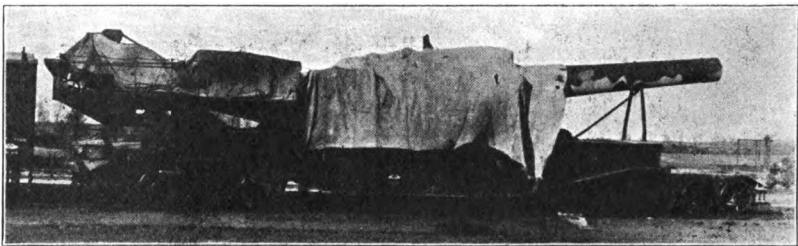
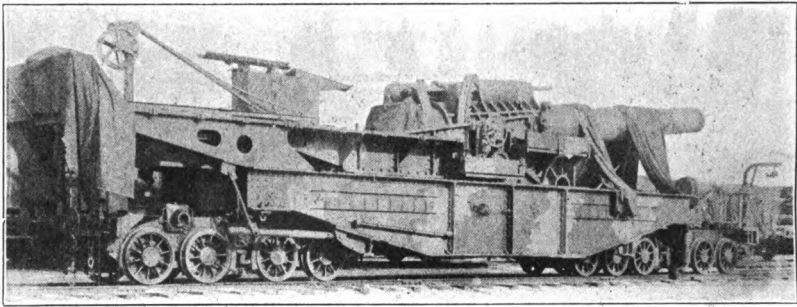

400-MM. HOWITZER MOUNT, TRAVELING POSITION.

secure. Beams 14 by 16 inches by 15 feet long are not easy to find even in ordinary times, and under present circumstances they are even more difficult to secure. It seems, therefore, that damage done to these firing platforms is well nigh as serious an injury as suffered by the mounts themselves.

520-MILLIMETER HOWITZER.

200. To the best of our knowledge this is the largest gun constructed during the war or to date and fires the heaviest projectiles (3,014 pounds) and heaviest explosive charge (660 pounds) so far used. The mount represents a fourth distinct type in that it com-

PLATE 102B

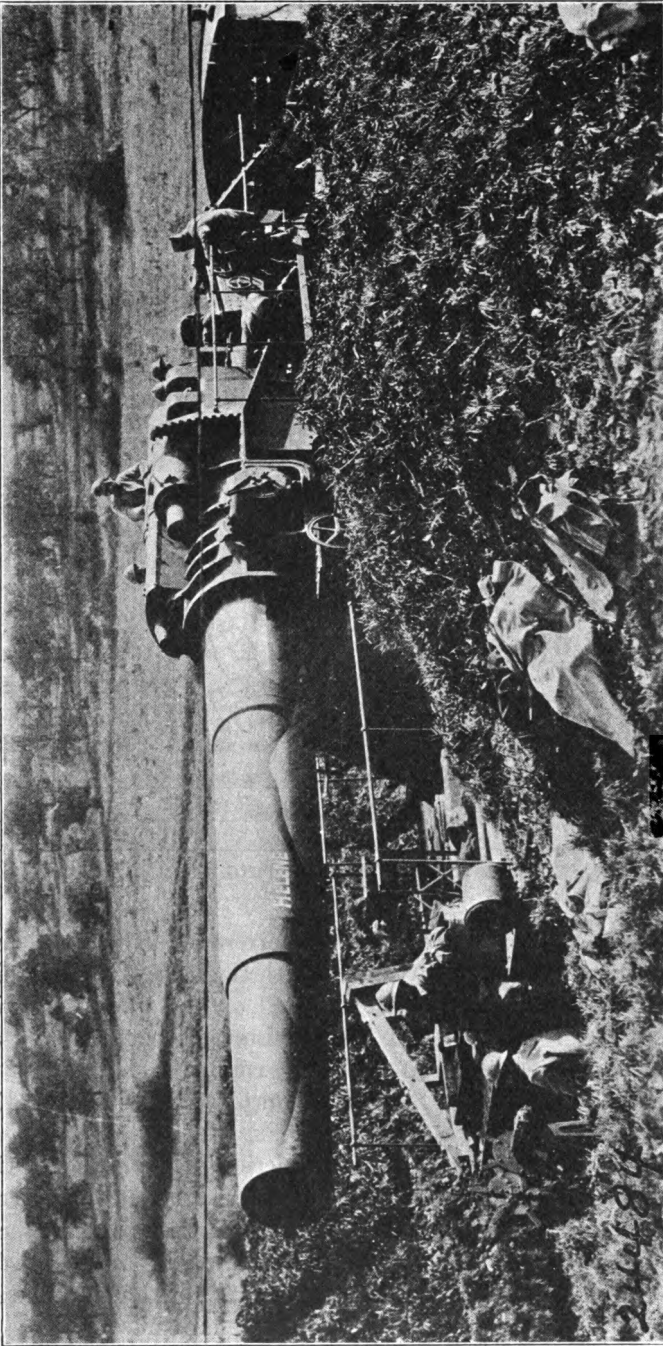

400-MM. HOWITZER IN BATTERY ON FIRING LINE.

bines the principles of cradle and sliding recoil. The force of recoil, 17,860 tons-meters, is so great as to make it impossible to mount the gun directly on the side girders of the car body and operate at high elevations—that is, up to 65 degrees. No track construction would stand such forces; hence the appearance of this fourth type.

201. A word about the history of the guns and mounts is of interest. At the beginning of the war the Germans sprung the surprise of the 420-millimeter mortars, which they used in quickly reducing the forts of Liege. There is evidence to indicate that some of these mortars were at one time mounted on railway carriages. Those now in our possession are on field carriages. These mortars were, of course, the surprise of the time and were unquestionably most effective. They were used again in the reduction of Namur, but to the best of our knowledge not again during the entire war. French designers were soon set to work on the 520-

PLATE 103

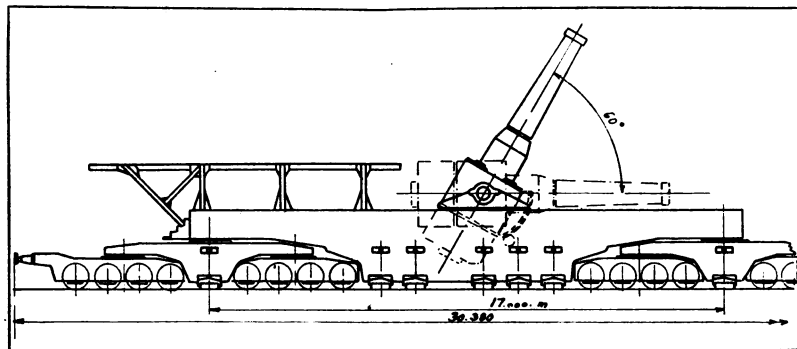

RAILWAY MOUNT OF SLIDING TYPE MOUNTING 520-MM. HOWITZER WITH CRADLE RECOIL.

howitzer, not particularly because there was any great need for them but to serve somewhat as a political gun. Although finished early in 1918, the guns were never used on the front. During the summer of 1918, while one of the mounts was being used to prove ammunition at the Quiberon proving ground, a shell burst prematurely in the bore of the howitzer, completely destroying the gun and carriage.

202. *Gun.*—The gun enjoys the distinction of being one of the only three or four new large guns that were designed, constructed, and mounted on a railway carriage during the war. It is 16 calibers long and has 168 grooves twisting to the right at an angle of 7 degrees. The breech mechanism is of the Schneider automatic type, with air recuperator and electric firing mechanism.

203. *Recoil mechanism.*—The gun is carried in a cradle, which is slung directly by its trunnions in bearings mounted on the side

girders of the car body. The cradle is provided with four hydraulic recoil cylinders and two pneumatic recuperators. The length of recoil in the cradle is 0.945 meter. In addition, the mount is of the sliding type and is provided with five sleepers under the car body and one under each span bolster, Plate 103. The length of sliding recoil is about 1 meter. The mount is returned to its firing position by an electric translating mechanism.

204. *Elevating mechanism.*—The elevating mechanism is provided for both hand and electric power operation. It comprises a rack bolted to the left side of the bottom of the cradle, Plate 105, and a train of spur gears leading to the handwheel just in front of the left trunnion bearing and to the motor mounted between the side girders forward of the gun.

205. *Traversing mechanism.*—The gun can be trained in azimuth only by moving the mount along a curved track. The translating or traversing is accomplished by two electric motors mounted in the outside trucks and connected to two axles each by chains. There is no provision for hand translating or traversing.

206. *System of anchorage.*—The mount is provided with seven sleepers or friction beams, five under the car body and one under each span bolster. These sleepers are forced down on the special firing beams by jackscrews exactly as in the 274, 305, 320, 340, and 370 millimeter sliding mounts. For details of the beams and jacks see Plate 119, Volume I.

207. *Trucks.*—The trucks, Plate 105, comprise structural steel frames carrying four axles each. The axles of the outside trucks are equalized in pairs, while those of the inside trucks are equalized throughout. Even in this extremely heavy mount, 236 metric tons, the braking is done entirely by hand. No air brakes were observed on any French mount.

208. *Ammunition supply system.*—The ammunition supply system is not unlike that of the other sliding mounts. In this case, however, the transbordeur is driven by an electric motor and all operations of handling, lifting, and ramming the projectile are likewise by electric motor. The special power plant seen at the end of the train in Plate 104, lower view, is kept about 100 meters from the mount when in action, and the current conducted to the mount and transbordeur by cables.

209. *Merits.*—This is an admirably designed piece of mechanism and is an example of the typical painstaking French workmanship.

210. *Demerits.*—Since the passing of heavy permanent fortifications there would seem to be no need for so heavy a weapon as this. It seems a waste of money and the time of valuable manufacturing facilities.

PLATE 104

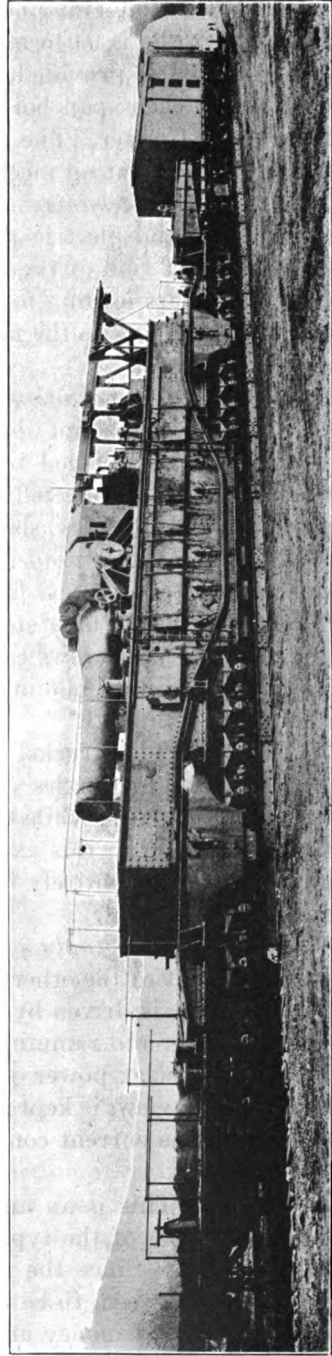
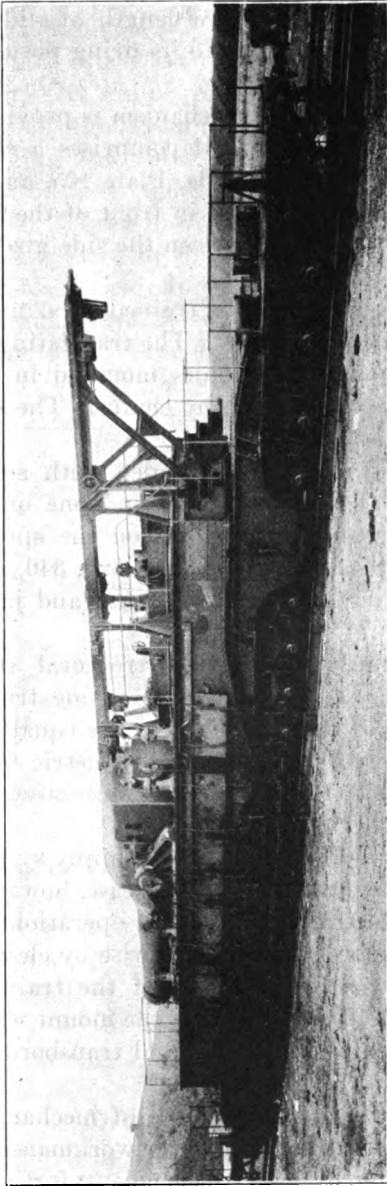

TWO VIEWS OF THE 520 HOWITZER ON SCHNEIDER MOUNT, IN POSITION TO LOWER ONTO STRUCTURAL BEAMS.

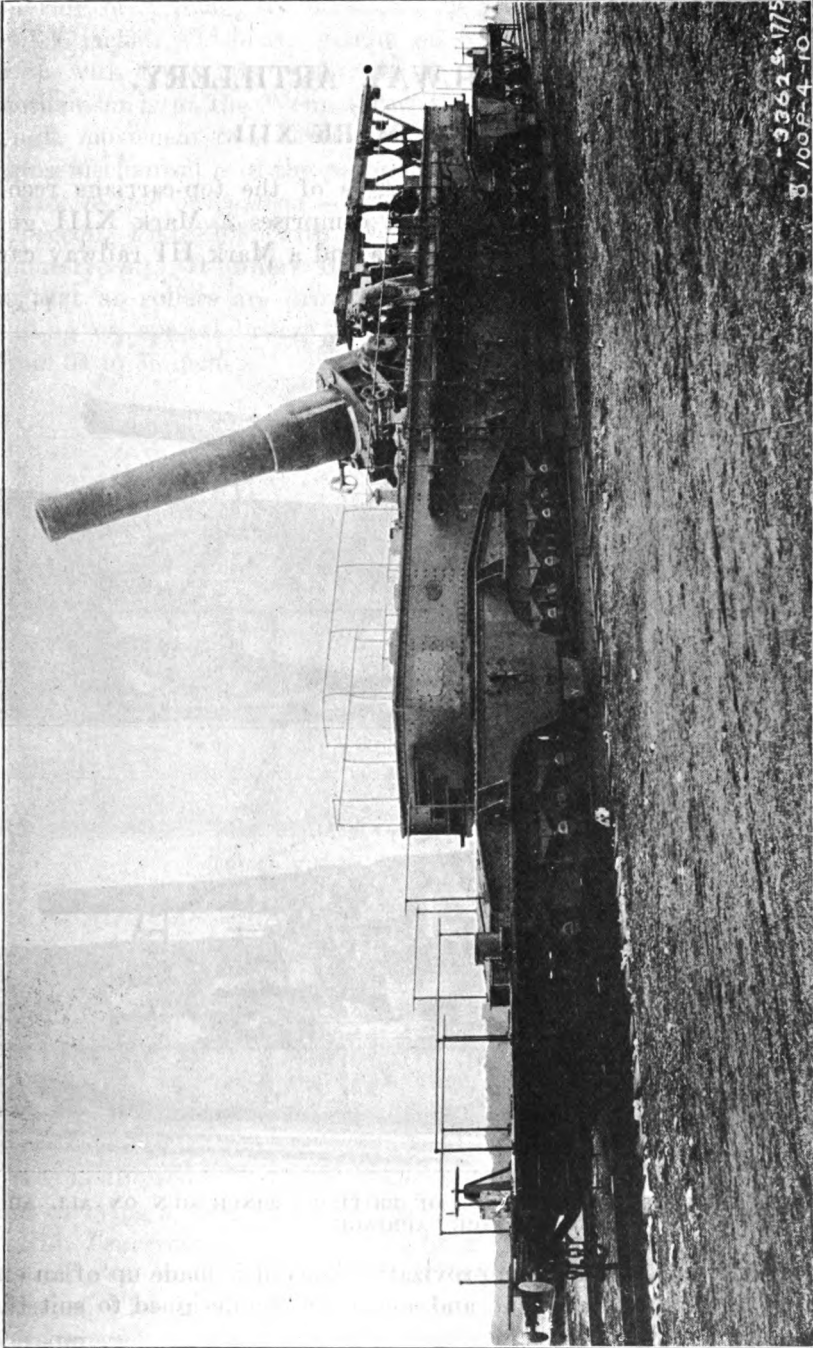

520-MM. HOWITZER RAILWAY MOUNT IN BATTERY POSITION.

BRITISH RAILWAY ARTILLERY.

9.2-INCH GUN, MARK XIII.

211. This mount, Plates 106-112, is of the top-carriage recoil and top-carriage traverse type. It comprises a Mark XIII gun mounted on a Mark IV top-carriage and a Mark III railway car.

PLATE 106

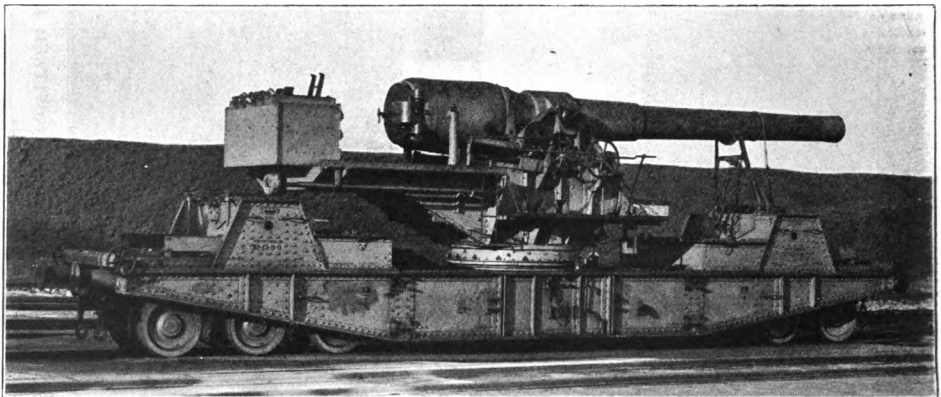
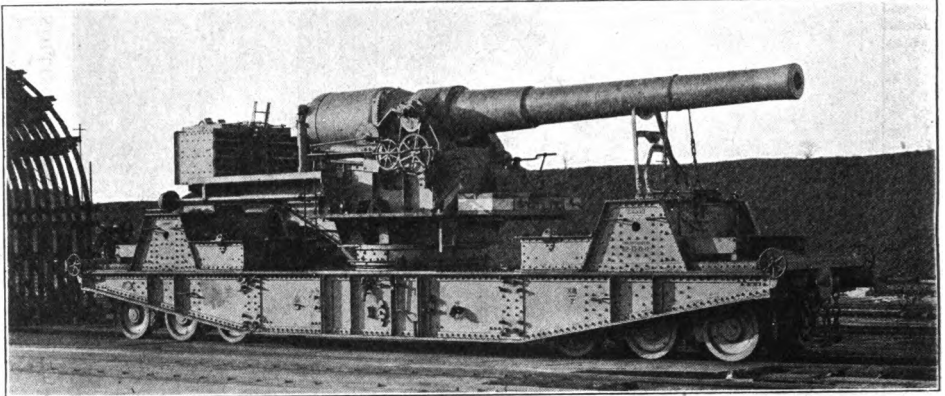

FRONT AND REAR VIEWS RIGHT SIDE OF BRITISH 9.2-INCH GUN ON ALL AROUND FIRE CARRIAGE.

It must be considered an improvization since it is made up of an existing coast mount and gun and a railway car designed to suit the peculiarities of the coast carriage.

(126)

212. *Gun.*—The gun is of the wire-wound type, comprising two interior, or A tubes, around which the wire is wound, and a B tube and a jacket, which are shrunk on over the wire. The trunnion hoop with trunnions is shrunk on over the jacket. The breech mechanism is of the Welin screw type and breech is opened by a single movement of a lever swinging in a horizontal plane. The firing mechanism is of the percussion type.

213. *Recoil mechanism.*—This mount has the top-carriage type of recoil, Plate 108, with a combination of spring and gravity counterrecoil. It differs from most of those previously described in that no rollers are provided under the top carriage, the latter sliding on special bronze liners instead. The maximum recoil is from 34 to 36 inches.

PLATE 107

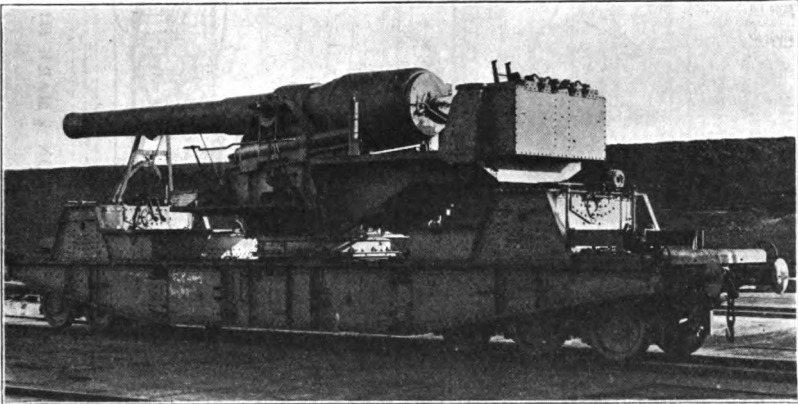

REAR VIEW LEFT SIDE ELEVATION.

214. *Elevating mechanism.*—The gun trunnions are supported on the top carriage on a special antifriction auxiliary bearing of the roller type. All of the elevating mechanism, Plate 109, is mounted directly on the top carriage and recoils with it. It consists of a rack attached to the gun, a pinion, a slip friction, a worm wheel and worm, leading through bevel gears to the handwheel. The ratio of the gearing is approximately three-fourths degree of elevation of gun per turn of handwheel. A total elevation of 40 degrees is allowed. Plate 108 is an illustration of an identical mount but carrying a Mark X gun, hence the elevation of only 30 degrees.

215. *Traversing mechanism.*—The rotating top carriage of this mount rests on a nest of 35 conical rollers and can be traversed 360 degrees, Plate 109. The lower roller path is provided with a traversing rack, and a pinion attached to the racer meshes with this and is operated through a worm and worm wheel, slip friction

PLATE 108

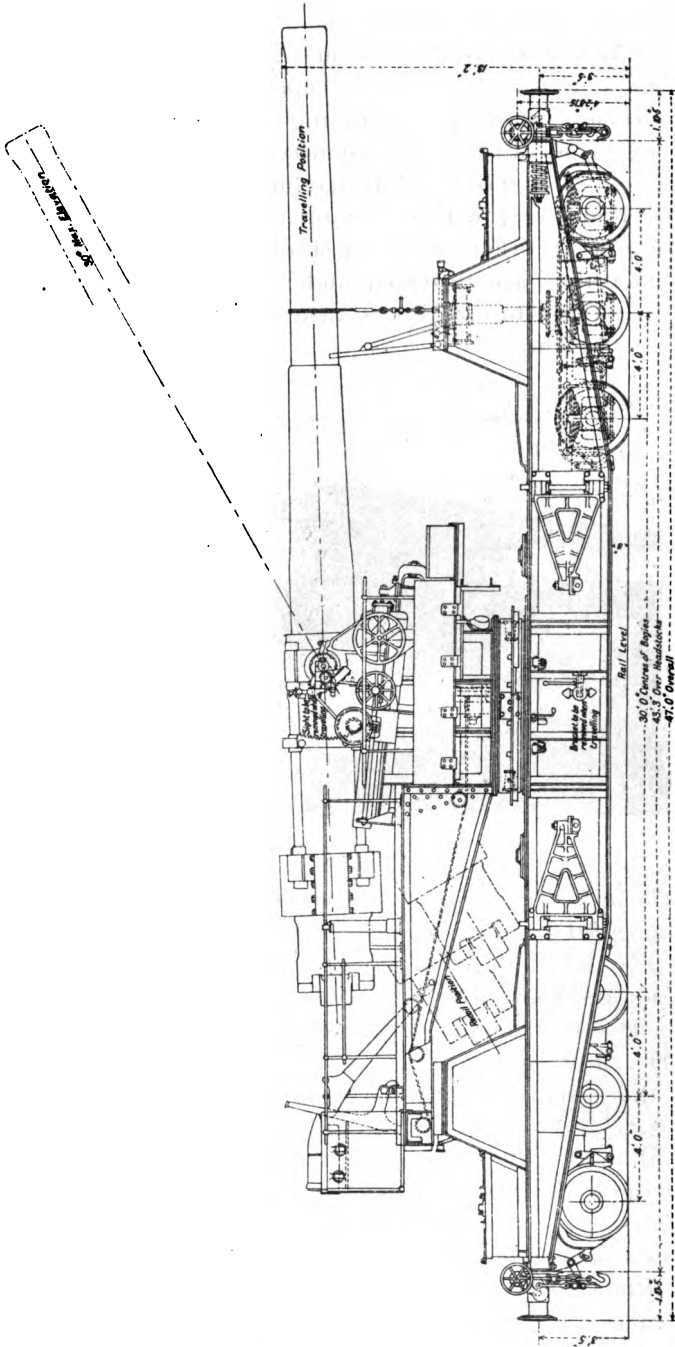

ASSEMBLY RIGHT SIDE ELEVATION BRITISH 9.2-INCH GUN MARK X ON A MARK III RAILWAY CAR, TRAVELING POSITION.

PLATE 100

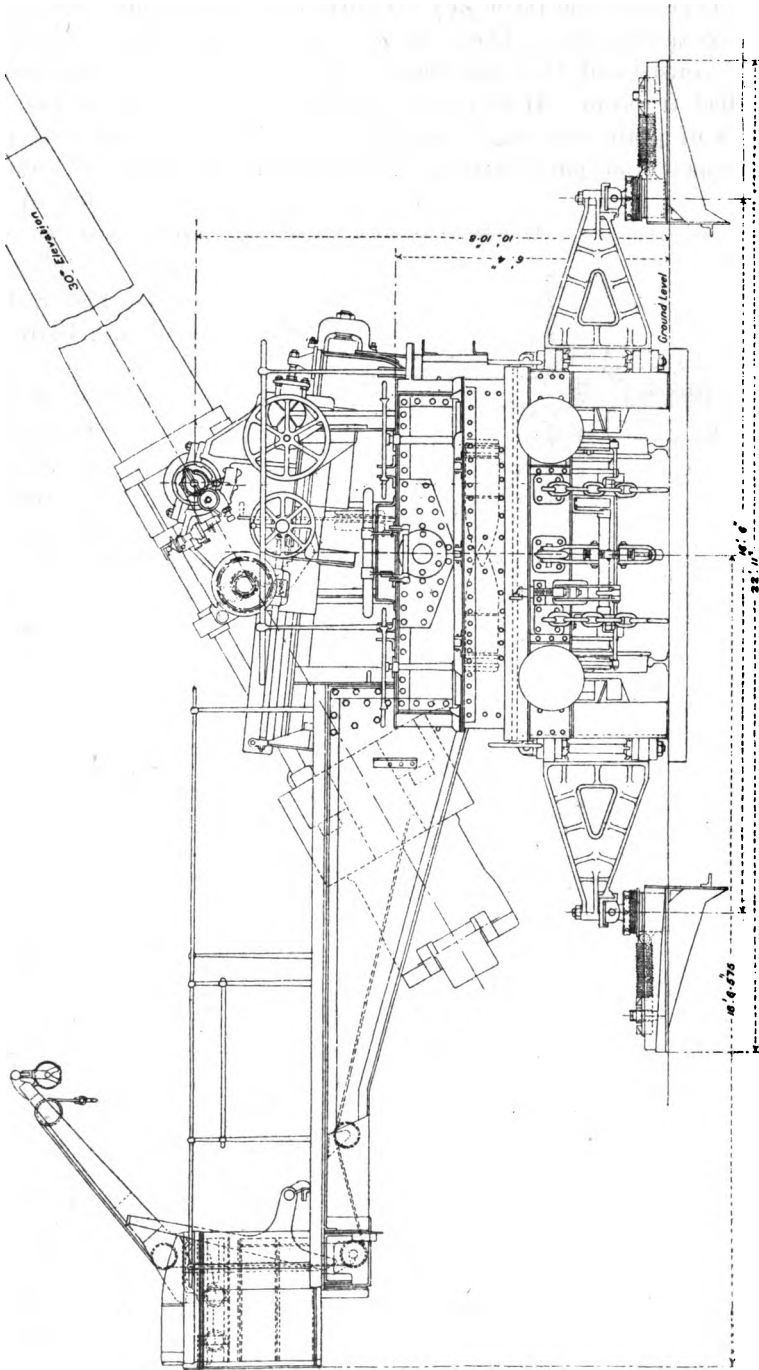

CAR ANCHORED FOR CROSS TRACK FIRE, 9.2-INCH MARK X GUN ON MARK III CAR.

device, two sets of bevel gears, and one set of spur gears, by a hand-wheel located on the racer just forward of the elevating handwheel.

216. *Gun carriage.*—The recoiling top carriage, Plate 107, of the mount consists of two cast-steel slides connected by a box-shaped cast-steel transom. It rests on a subcarriage built up of two side girders of plate and angles, connected by transoms and resting on the upper roller path castings. The loading platform is attached to the back of this rotating portion.

PLATE 110

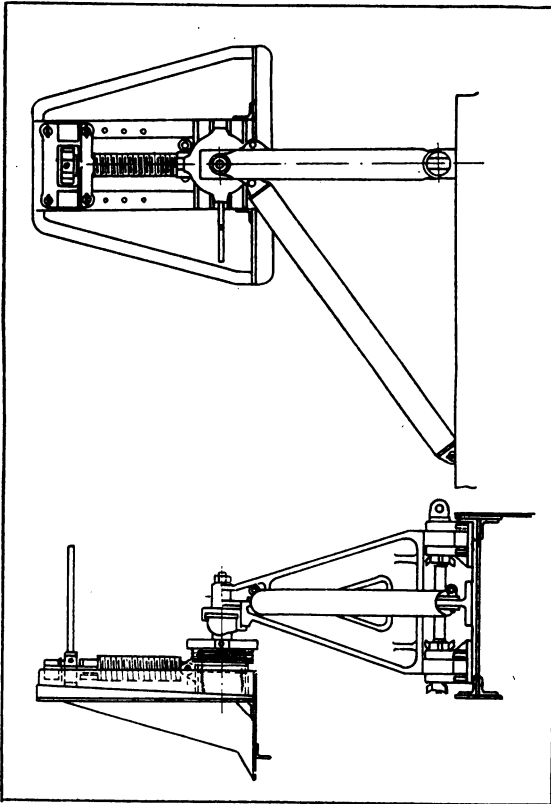

PLAN AND ELEVATION VIEWS OF OUTRIGGER FOR CAR MARK III.

to the back of this rotating portion.

217. *Railway car body.*—The railway car body, Plate 106, is of the "flat" type, constructed of structural steel with plate girder side sills fitting down over the outside of the trucks, suitable transoms, etc. The car body is mounted on the trucks through hydraulic jacks at the center pins, and it can be raised and lowered as a unit by them through a distance of 16.75 inches. Four hinged struts, similar to those on the Schneider 200-millimeter howitzer, are attached to the side girders, Plates 109–110.

218. *System of anchorage.*—For firing, the mount is lowered until the side girders rest upon the ties, as shown in Plate 109, the hinged struts are swung out and braced in position, and special spades, shown in detail on Plate 110, are put under them. The writer was told by the battery commander in charge of a gun of this model that these outriggers and spades were very satisfactory. On the mount observed in firing position on the British front two 1-inch cables or holdfasts, attached as shown in Plate 111, were used in addition to the out-

riggers. Deadmen for these cables were 16 by 16 inches by 12 feet, buried 6 feet under the surface of the ground. Instead of being lowered directly on the ties, as shown in the plate, the mount observed was lowered onto a special platform similar to that used with the American 8-inch mount.

219. *Trucks*.—The trucks are six-wheel, with 5.5 by 10 inch inside journals, structural steel side frames, and semielliptical springs.

220. *Ammunition supply system*.—A special rack holding seven shells and the corresponding powder charges is located on the loading

PLATE 111

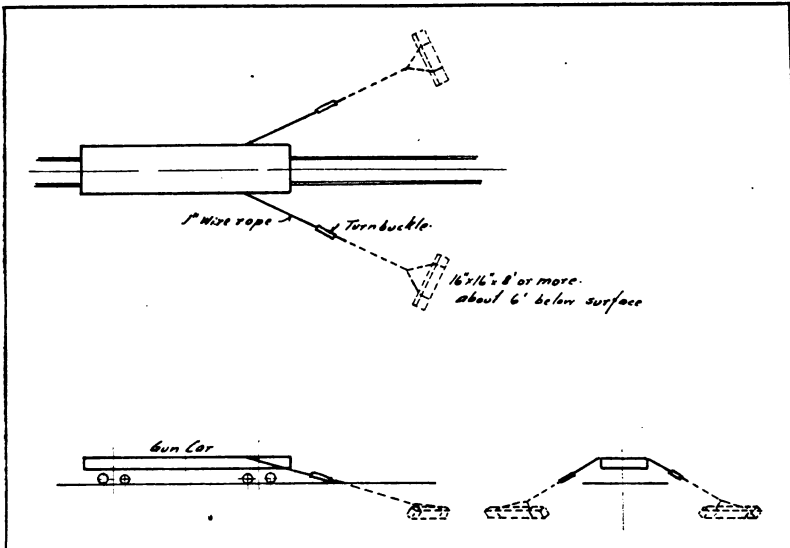

ADDITIONAL ANCHORAGE USED ON 9.2-INCH GUN MOUNTS ON FIRING LINE AT FRONT.

platform, Plate 112. A track, which can be swung out of the way, leads from this to the breech of the gun, and a shot truck is arranged to run upon it. A jib crane is used to load the shell onto the truck.

221. *Difficulties involved in the service*.—It was understood from the battery commander handling these mounts that they had continual trouble with their system of anchorage. The outriggers do not hold, and the guys are not particularly desirable. On inquiry it was found that they have never used any rail clamps with this mount when firing parallel to the track. On suggesting the possibility of using rail clamps, they decided to make a trial of them.

PLATE 112

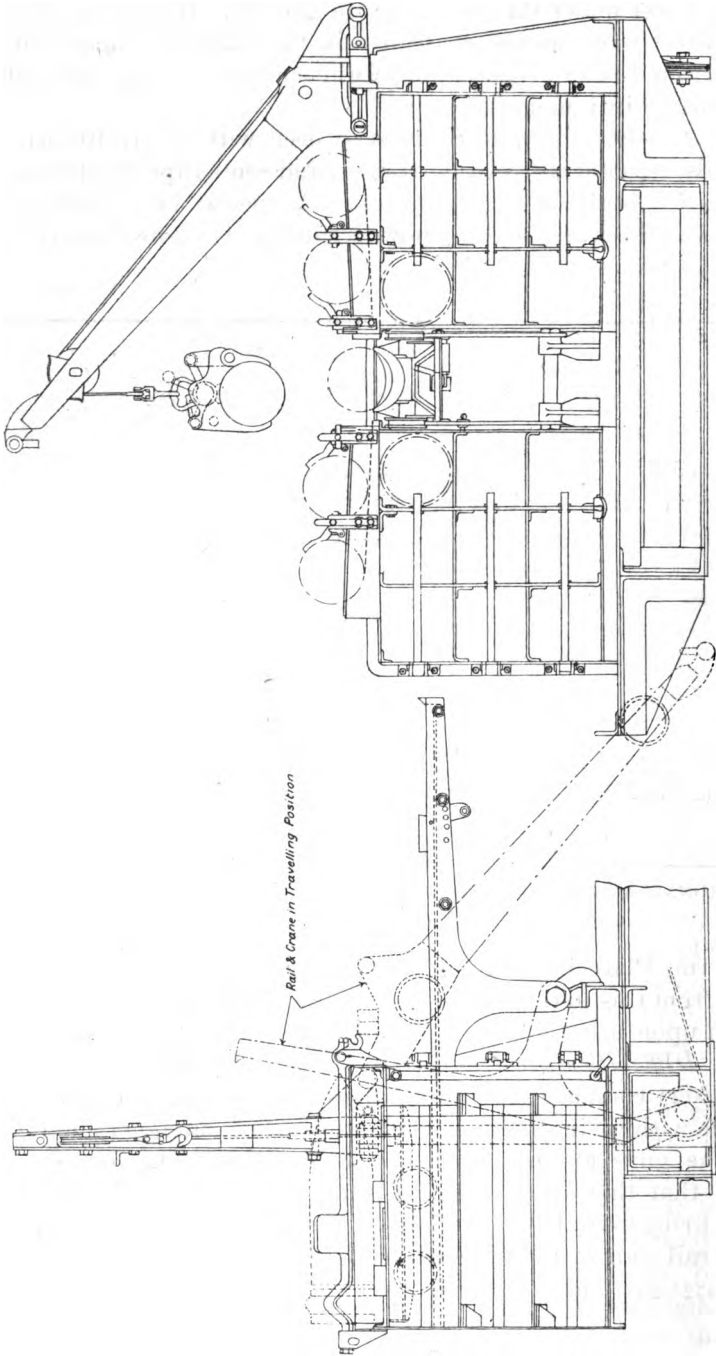

ASSEMBLY OF AMMUNITION SUPPLY UNIT FOR 9.2-INCH GUNS.

9.2-INCH GUNS, MARKS X AND XIV.

222. The mounts used with these guns is identical with that just described. In fact, the illustrations used for the previous mount were taken from a handbook issued for these guns. The top carriage is given as a Mark III instead of a Mark IV, as for the previous mount. The only difference is in some slight details incident to the mounting of a gun of slightly different length. The description of the preceding mount applies equally to this, with the exception noted.

223. *Elevating mechanism.*—Elevation is limited to 30 degrees.

BRITISH 9.2-INCH GUN, MARKS III TO VIc.

224. This is a general type of improvised mount, including seven different types of guns—Marks III, IV, IVa, VI VIa, VIb, and VIc; also two types of carriages—Mark I and Mark II; and three types of railway cars—Marks I, Ia, and Ib. The Mark II mounting and the Mark Ia railway car, as shown on Plate 113, will be described.

225. *Gun.*—Guns of all the models above are of the built-up steel tube type and are provided with fixed trunnions. An interrupted screw breech mechanism fitted with a percussion firing mechanism is provided.

226. *Recoil mechanism.*—The carriage is improvised from an old naval mounting of the top-carriage recoil type. Two hydraulic cylinders are provided and 34 inches of recoil is allowed. On the original carriage counterrecoil was probably by gravity, but in order to give increased elevation the slides have been mounted at an angle of depression, so that the gun recoils down, and two counterrecoil springs, Plate 114, are provided to return the gun carriage to battery.

227. *Elevating mechanism.*—The elevating mechanism consists of a rack bolted to the gun, and a pinion, slip-friction device, worm wheel, and worm attached to and recoiling with the carriage, Plate 113. The worm shaft is arranged longitudinally, parallel to the direction of recoil, and does not move, the worm simply sliding along it. The operating handwheel is at the rear end of this shaft. Elevation to 35 degrees is provided.

228. *Traversing mechanism.*—The gun carriage is of the front pintle type, and a traverse of 10 degrees on each side of the center line is allowed. The traversing mechanism consists of a screw extending across the car at the rear end of the carriage and provided with handles at each end. A nut on this screw is so attached to the carriage that the back end of the latter is carried from side to side with it.

229. *Gun carriage.*—The gun carriage is of the same type as the preceding, but it is mounted on a wedged-shaped piece of structural

ELEVATION

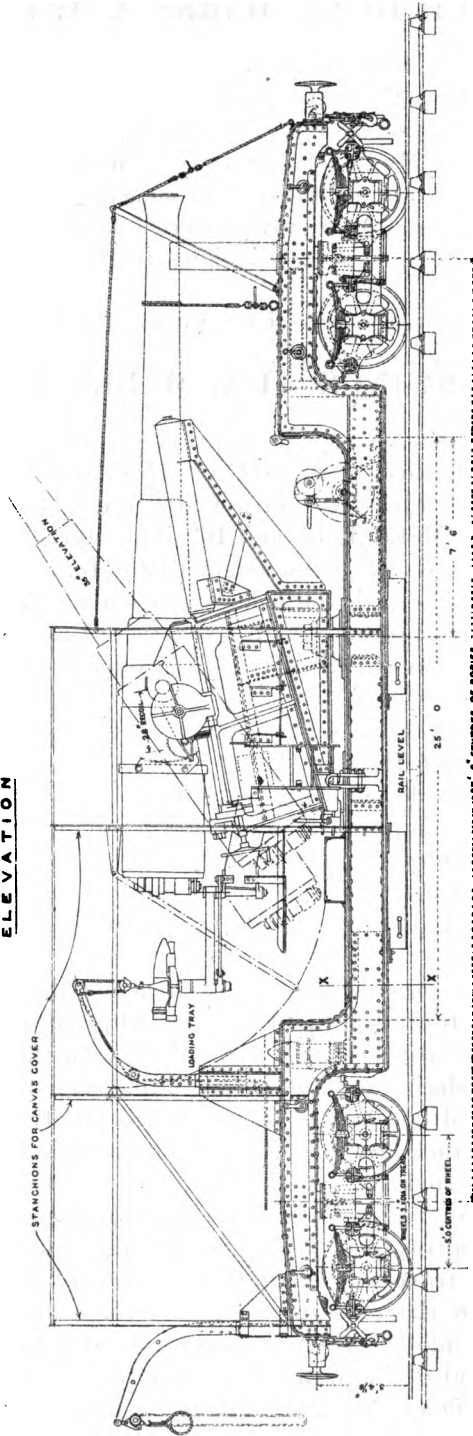

9.2-INCH GUN ON MARK II MOUNT AND MARK Ia CAR.

PLATE 114

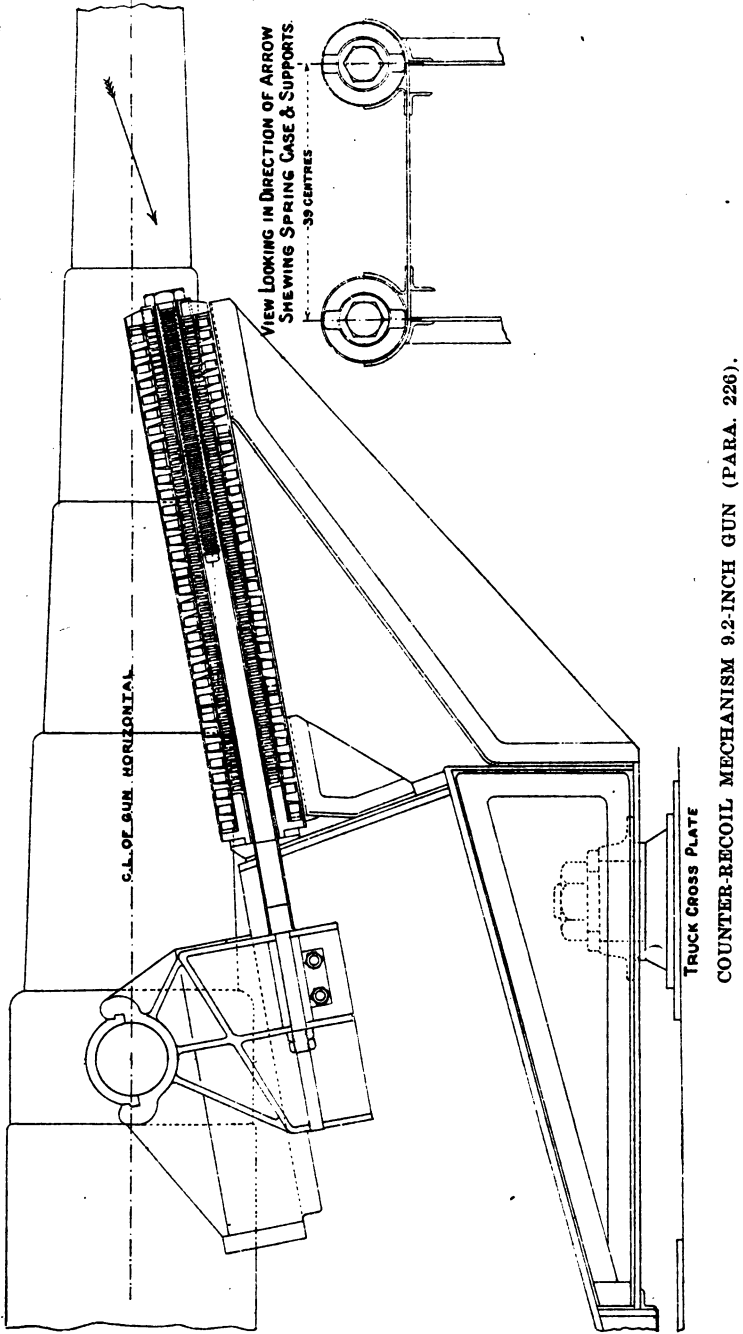

steel, so that additional elevation is given the gun. No traversing rollers are provided.

230. *Railway car body.*—The car body is of structural steel and is of the well type. It is provided with a warping winch, worked by hand, by means of which the mount can be pulled along the track.

231. *System of anchorage.*—This mount is provided with the rolling type of anchorage. To prepare for firing, a longitudinal stringer of teak wood is swung between the underside of the side sill of the car and the rail, leaving about half an inch of clearance. The brakes are set, the rails greased on the inside, and the warping rope is unfastened. On firing, the entire mount descends on the springs until the stringer and rail come into contact, and the whole mount rolls backward along the track. The warping rope is then connected, the brakes released, and the mount is pulled up into firing position again.

232. *Ammunition supply system.*—Two jib cranes, Plate 113, serve to pass the shells from the rear of the mount up to the loading tray at the breech.

12-INCH HOWITZER, MARKS I AND II.

233. This mount, Plates 115–116, is of the cradle recoil, top-carriage traverse type, and obviously is an improvisation from an existing coast howitzer and carriage. The British Army used a great number of mounts of this general type during the years 1917 and 1918. Railway artillery was classed as army artillery in the British Army, and one found the various mounts more or less permanently emplaced in their firing positions all along the line. The writer examined one of these mounts in the Ypres sector, which was then (March, 1918) under the charge of the Fourth Army. This mount was at the end of a spur track and in a location that required so much excavation that the top of the mount barely reached the level of the ground. This position was not more than 500 yards from the line, which at that time was on Zonnebeck Ridge. There was considerable evidence that there had been difficulty in holding the mount in position, for heavy timbers were all about the carriage, bracing it against the banks on either side, and heavy cable holdfasts in front.

234. *Gun.*—Both howitzers are of the wire-wound type. They comprise an inner tube and an outer jacket between which at the breech end the wire is wound. The breech mechanism is of the interrupted screw type operated by the continuous turning of a handwheel. The firing mechanism is of the percussion type. These two howitzers are fitted on both sides with splines that check the

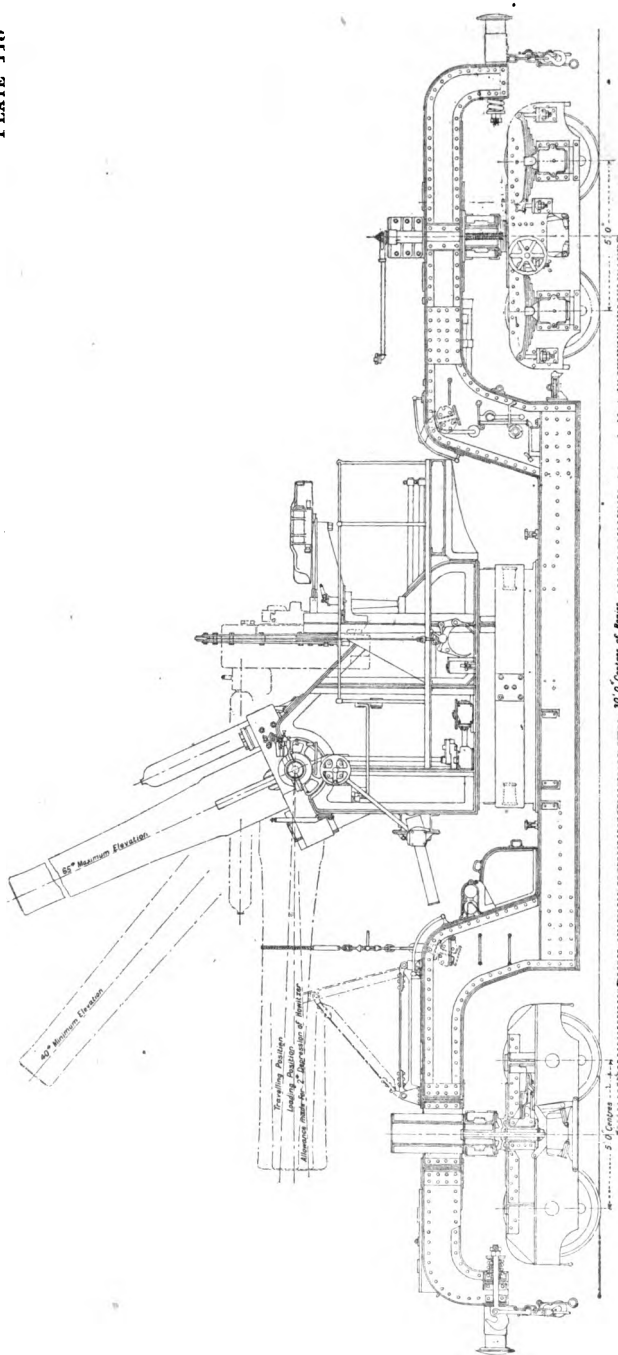

BRITISH 12-INCH HOWITZER, MARKS I AND II TRAVELING POSITION.

Scale = 1/25

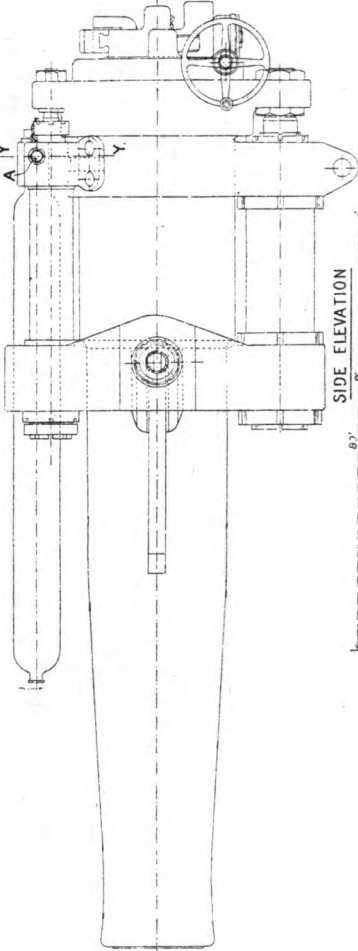

SIDE ELEVATION

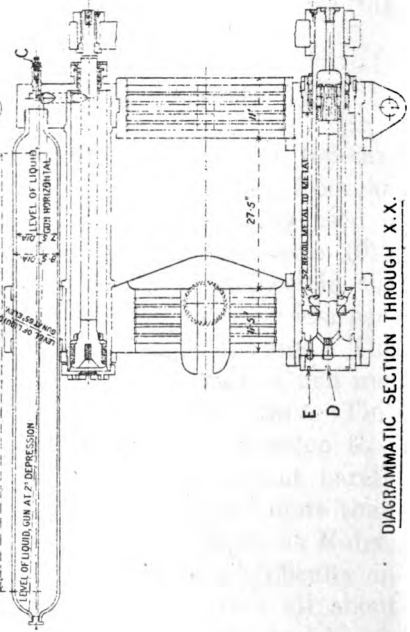

DIAGRAMMATIC SECTION THROUGH X. X.

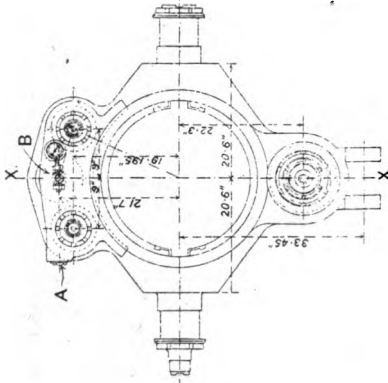

REAR VIEW GUN REMOVED.

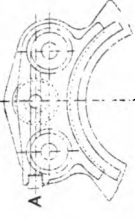

SECTION THROUGH Y. Y

ASSEMBLY OF RECOIL AND COUNTER RECOIL MECHANISMS.

rotation of the gun in the cradle, the weight being carried by 10 narrow cylindrical bronze liners, Plate 116.

235. *Recoil mechanism.*—The recoil mechanism, Plate 116, is of the hydro-pneumatic and of the favorite British design in which the liquid of the pneumatic recuperator is constantly in contact with the air. The length of recoil is 32 inches. The single buffer cylinder is mounted in the center at the bottom of the cradle and the two recuperator cylinders on either side of the center at the top, the air reservoir being mounted in the center between them. There is nothing unusual about the buffer nor in fact about the recuperator. The recuperator is an interesting design, however, and of a type not used by ourselves except on the 8-inch field howitzers designed by the British and built by the Bethlehem Steel Co. in large numbers for us as well as for England.

236. *Elevating mechanism.*—This elevating mechanism, Plate 115, is in duplicate, combining both a slow and rapid operation. It comprises a single screw attached to the bottom of the cradle and passing through a nut that can be connected by a clutch with either the slow or rapid gearing. The minimum elevation at which the howitzer can be operated is 40 degrees and the maximum is 65 degrees. Operation at elevations of less than 40 degrees would bring the line of recoil sufficiently without the base of the top carriage as to turn it over.

237. *Traversing mechanism.*—The gun carriage, Plate 115, rests on a series of conical rollers which in turn rest on a circular track on the bed of the car. It is possible to traverse this carriage 360 degrees, but firing should take place only within 20 degrees on either side of the track center line.

238. *Gun carriage.*—The gun carriage, Plate 115, is of the barbette type and comprises two structural-steel side frames mounted on a racer of ordinary design and connected with each other by a transom and the operating platform. The crane used in lifting the shells from the ground to the tray is mounted on this working platform, although it is not shown on the cut.

239. *Railway car body.*—The railway car body, Plate 115, is of the platform type and not materially different from that used with the Mark III and Mark V howitzers, Plates 117–120. A comparison with Plates 117–120 will show that there is no fundamental difference.

240. *System of anchorage.*—The mount of this type that was found in use on the British front was resting on a firing platform, very similar to that used with the American 8-inch car. Over the front and rear trucks are located screw jacks used in raising the car for placing or removing the platform. In addition to this platform the car was anchored forward by two 1-inch steel

cables attached to 16 by 16 inch by 12 foot beams buried 6 feet below the surface of the ground. For lateral bracing 12 by 12 inch timbers were placed between the side of the car about in line with the center of the tracks and an improvised timber platform in the back beside the car. The entire anchorage system seemed an unsatisfactory improvisation.

241. *Ammunition supply system.*—The scheme of transferring the projectile from the ground into the gun is the same on these two mounts, but unlike the scheme employed for the Mark V howitzer, Plate 117. This equipment comprises a crane located on the left side of the working platform by which the projectile is transferred to the tray carried on the arm attached to the left side frame of the top carriage. When the arm is swung to the right the lip of the tray enters the breech of the gun and the projectile is rammed by hand.

12-INCH HOWITZERS, MARKS III AND V.

242. The mounts for these two cannon are identical in design. They are shown on Plates 117–120, some of which are labeled for the one and some for the other. It will be seen from a comparison of Plates 117–120 with Plate 115 that there are many differences in the design of the various details of the top carriage, cradle, loading system, and elevating gear. Some of these differences will be discussed in detail later.

243. *Gun.*—There are no essential differences between the design of the interior of these howitzers and the Marks I and II. The Marks I and II howitzers, however, were fitted with splines on either side and were carried in the usual type of cylindrical cradle while these pieces are provided with guide hoops, by which the gun is supported on the top of an open or under type of cradle quite similar in design to that used with the 8-inch field howitzers. There are no essential differences in the design of the details of the breech mechanism.

244. *Recoil mechanism.*—The cradle and recoil mechanism are shown best on Plate 117. The cradle is made up simply of plates and special angles and the design of the individual units of the recoil mechanism is not unlike that of the similar units of the Marks I and II mechanism. There are two hydraulic buffer cylinders and one pneumatic recuperator cylinder, in which the liquid is always in contact with the air. The pistons of all three cylinders are attached to the recoil lug at the rear. The maximum recoil is 62 inches with full charge and at an elevation of 45 degrees.

245. *Elevating mechanism.*—The elevating mechanism, Plate 120, is not essentially unlike that of the previous mount. The nut through

PLATE 117

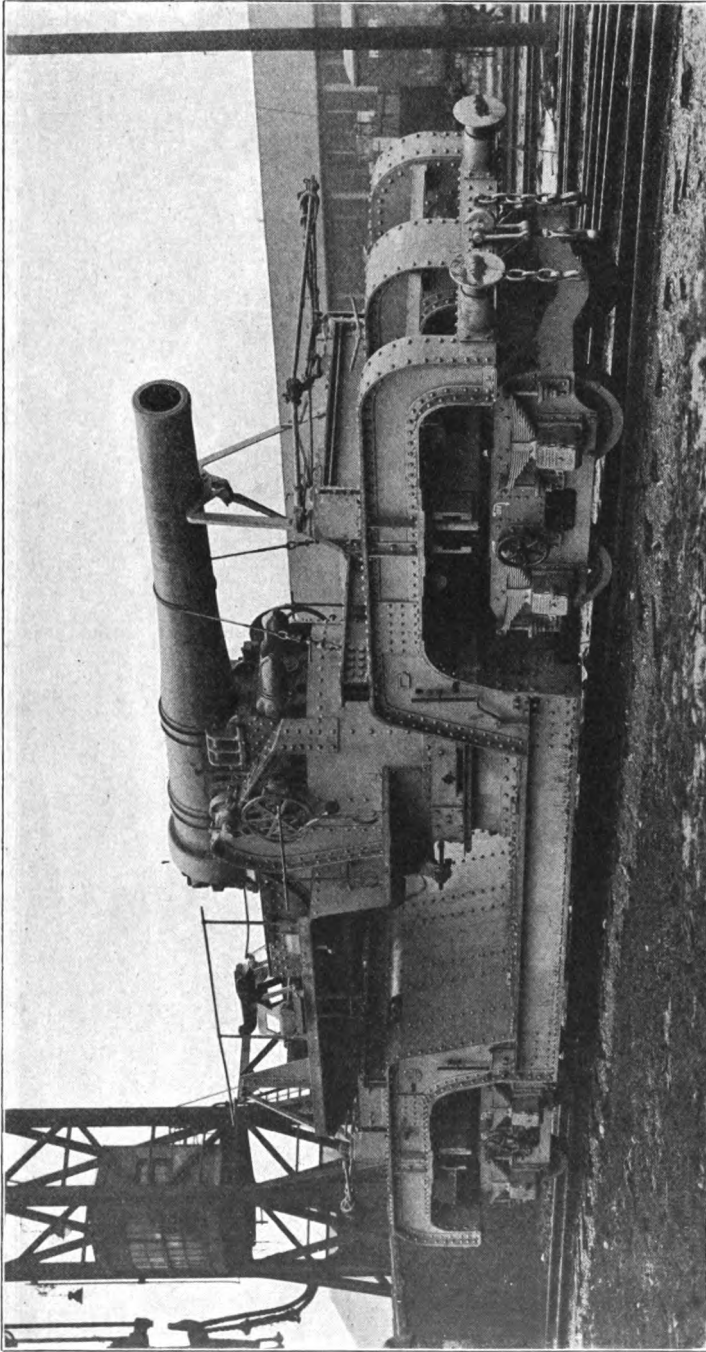

BRITISH RAILWAY MOUNT WITH 360° TRAVERSE TOP CARRIAGE, MOUNTING 12-INCH HOWITZERS MARK III AND V.

PLATE 118

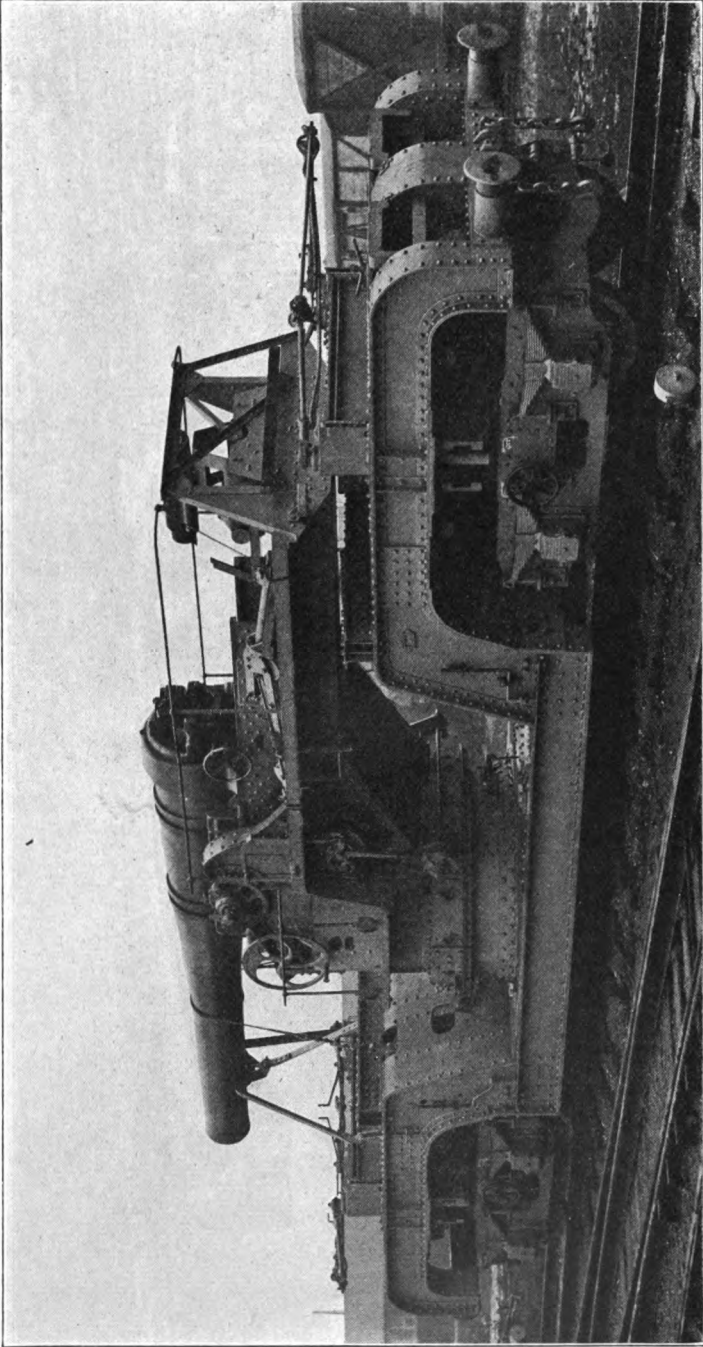

REAR VIEW LEFT SIDE TRAVELING POSITION.

which the elevating screw passes is mounted between the side frames of the top carriage and somewhat to the rear instead of outside and at the front, as on the Mark I mount. This mechanism is provided for both slow and rapid operation, as with the other, and the details of the design of this feature are the same. The elevating handwheel is mounted on the left side of the carriage.

246. *Traversing mechanism.*—See the same for the Mark I mount.

247. *Gun carriage.*—A comparison of Plates 115 and 120 shows a difference in the shape of the side frames of the top carriage and quite a difference in the working platforms. The racers, roller paths, and bases are quite similar. There is nothing sufficiently unusual in the design to merit detailed description. All that one can be interested in is to be seen from inspection of the plates.

248. *Railway car body.*—The slight difference in design of this car body from the Mark I body is nonessential. The body is of structural steel throughout. Jack screws are provided at either end for use in emplacing the mount. They will be mentioned in detail later.

249. *System of anchorage.*—The system of anchorage is not unlike that for the Mark I mount. Heavy beams are placed under the well section of the car body and holdfasts can be used in front if desired. On the other hand the mount can be permitted to slide to the rear on the beams and after raising the mount from the beams it is brought back to firing position by means of the warping winch installed in the forward vertical leg of the car body. Emplacing jack screws are incorporated over each truck, by means of which the car body can be raised from the truck to allow placing of the beams and likewise raising of the car body to permit a return to firing position. It will be observed in the photographs, Plates 117–120, that the two screws over each truck are driven by ratchet levers which are connected with each other in parallelogram fashion and ropes are attached on either side so that crews of men on the two sides of the mount can exert sufficient force to turn the screws up or down as desired.

250. *Ammunition supply system.*—The projectiles are transferred from the ground to the tray by means of a demountable crane which can be attached to the rear of the working platform as shown on Plate 120. It can be seen on the side of the platform on Plate 118. The cable of this crane goes to a winch in the rear of the top carriage where it is operated by a handle that can be seen on Plate 120. This mount is provided with a shot truck mounted on a special track. The truck is run forward from its permanent track over a hinged bridge onto special rails in the cradle until it bumps the breech of the gun. The projectile is rammed by hand.

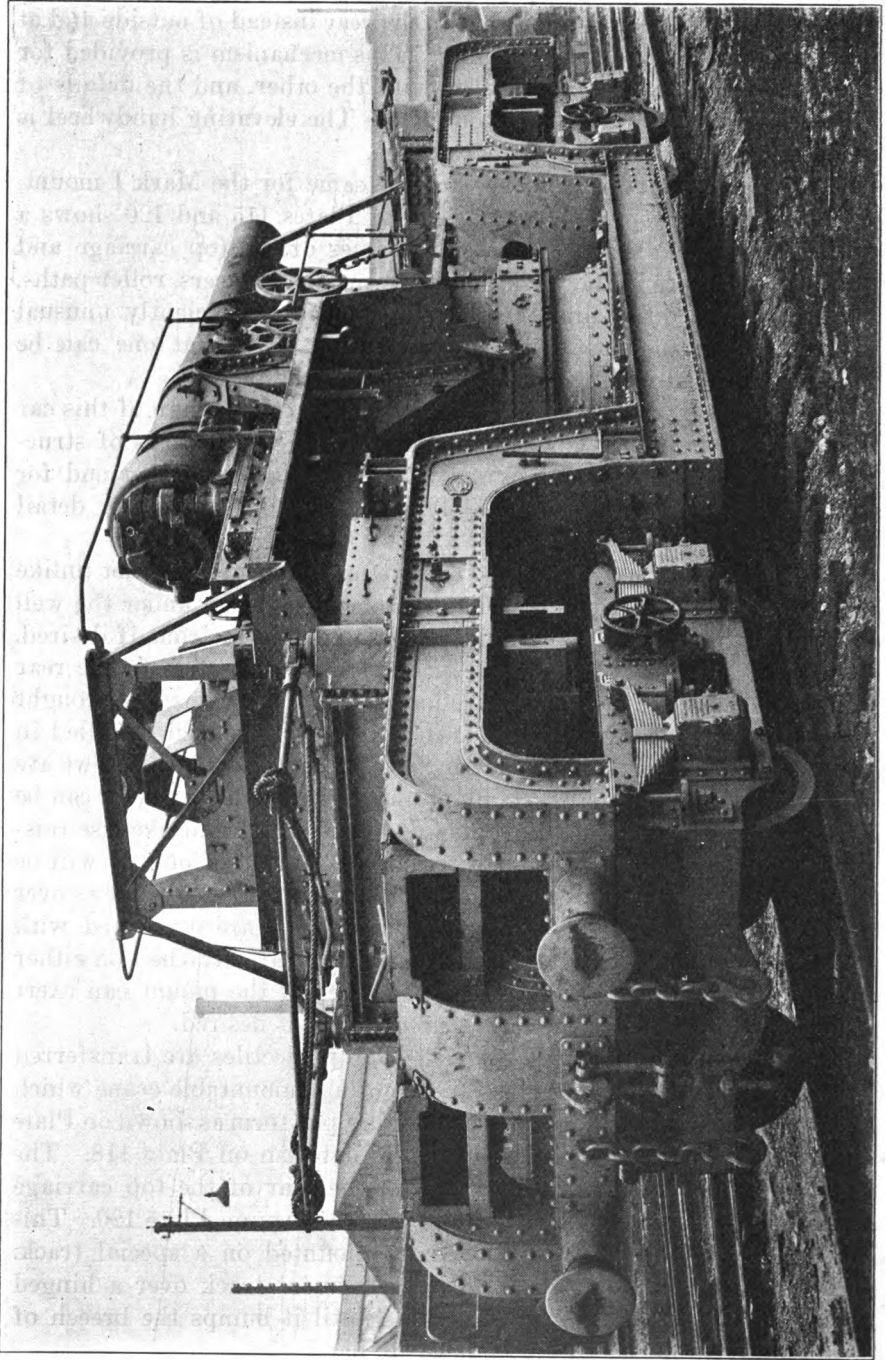

REAR VIEW RIGHT SIDE TRAVELING POSITION.

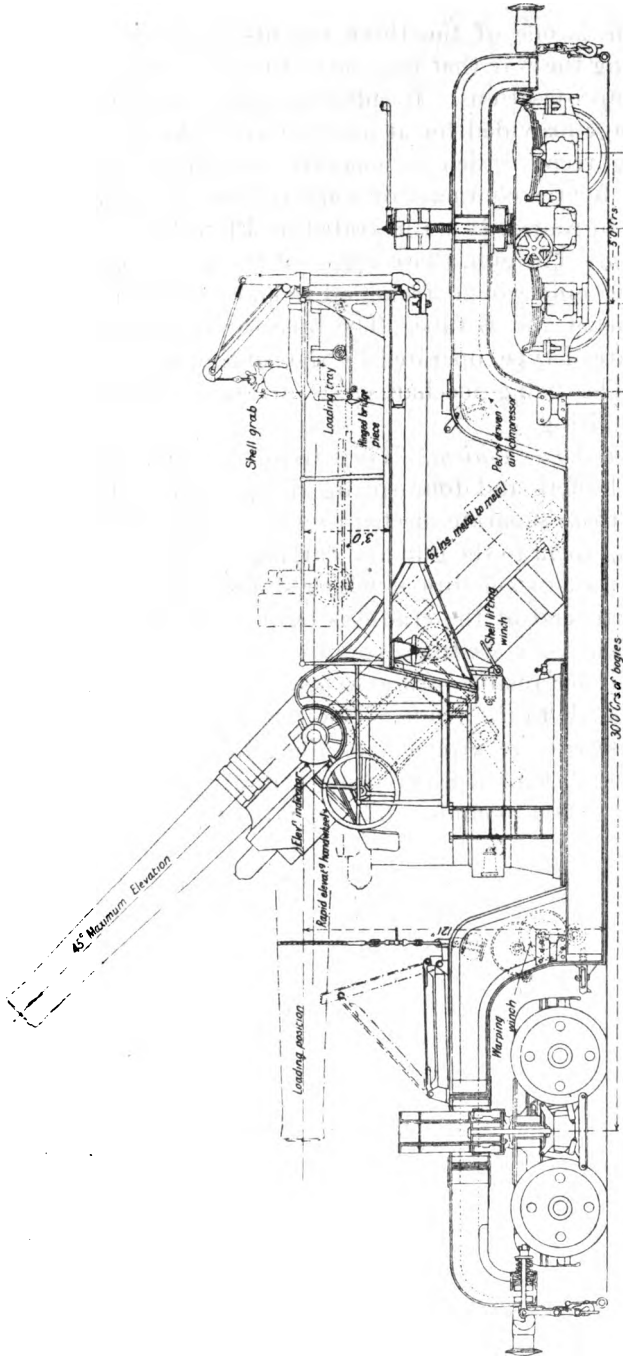

12-INCH HOWITZER MARK III AND V. CAR LOWERED ON TO BEAMS FOR FIRING.

12-INCH GUN, MARK IX.

251. This is one of the three mounts developed for the British army during the war that may be considered really developments instead of improvisations. It embodies a high-powered gun, mounted on a carriage provided for at least a fair elevation, 35.5 degrees, and for rolling recoil which is generally considered an admirable development for the character of warfare that circumstances compelled both sides to wage. It is illustrated on Plate 121.

252. *Gun.*—The gun, Plate 122, is of the wire wound type, the wire in this case being wound from end to end between the second A tube and the jacket and B tube. The breech mechanism is of the Welin stepped thread type, operated by the continuous rotation of a single handle. The firing mechanism is arranged for either electric or percussion firing.

253. *Recoil mechanism.*—This recoil mechanism comprises two hydraulic buffers and four spring recuperators. The design of the details of these separate mechanisms is not unusual, but the method of applying them to the gun and carriage is unique. The gun is supported on a cast-steel slipper which slides on the rails of the cradle. The forward end of the cradle is built up to encircle the gun completely. The side castings contain the trunnions. Three of the spring cylinder pistons are attached to the cast yoke over the gun and the fourth to the front of the cradle below. The spring cylinders themselves are attached to the gun and recoil with it. The initial working load of each spring cylinder is 10,296 pounds and the maximum 38,000 pounds. The maximum length of recoil is 33 inches.

254. The hydraulic cylinders are attached to the cradle on either side of the gun and at the rear. The pistons are attached to the slipper and are in compression when the gun recoils, instead of in tension, as is the general rule. An automatic leakage pump is provided in connection with these cylinders. The liquid used is a half-and-half mixture of glycerine and water.

255. In addition to the recoil mechanism just described the mount is permitted to roll back on the track on firing. The brakes are set hard and serve to check the recoil of the mount within a distance of about 40 feet. A special gasoline engine driven capstan is provided on the front truck, Plate 123, to pull the mount back to its firing position.

256. *Elevating mechanism.*—The elevating mechanism comprises two racks fastened to the lower side of the cradle, engaged by two pinions mounted on the same shaft, a worm wheel mounted on this shaft, and a worm operated through bevel gears from two hand-wheels located on either side of the car body. The mechanism

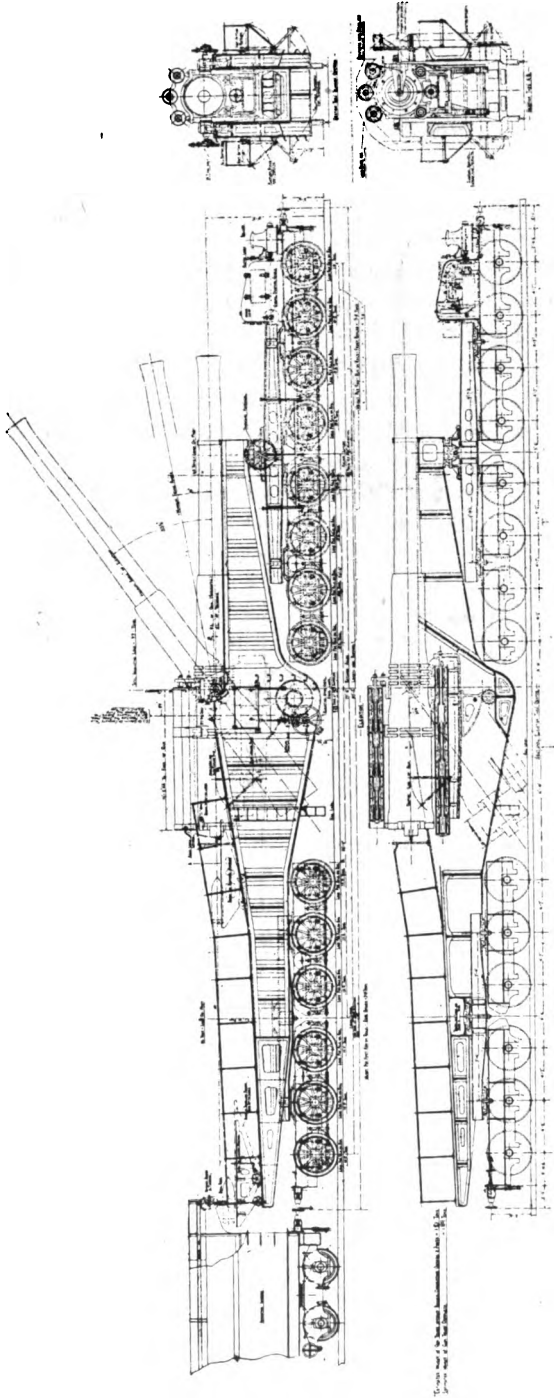

12-INCH GUN, MARK IX ON CRADLE RECOIL AND ROLLING TYPE MOUNT.

PLATE 122

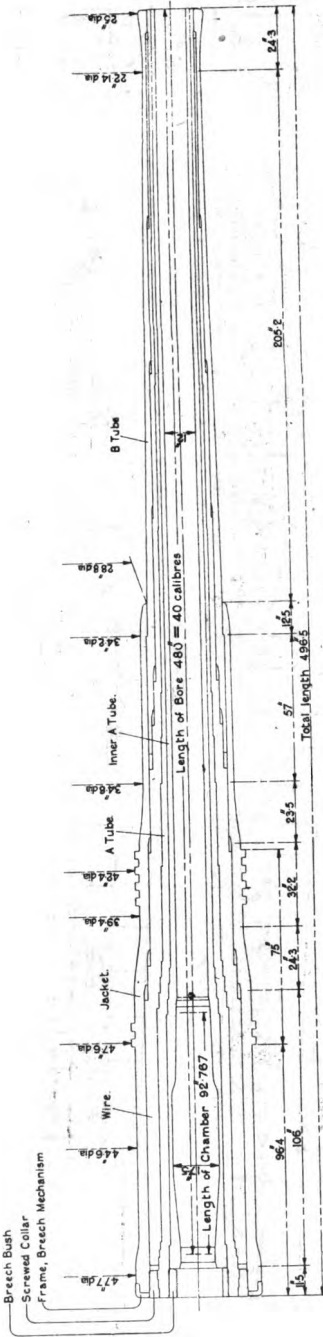

Rifling—Uniform twist of 1 turn in 30 calibre.
 Total length — 361.425
 Number of grooves — 48
 Right Hand Twist

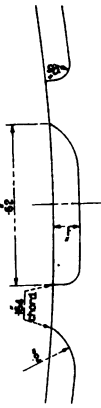

Charge, 24 lbs. M. D. 45 234 lbs. M. D. 37.
 Velocity, 2525 f.p.s.
 Muzzle Energy, 37580 ft.
 Pressure, 18 tons/sq. in. Max. Wgt.
 Range at 30°, 23100 yds approx.
 Capacity of Chamber, 17910 cubic ins.

12-INCH 40 CALIBRE GUN MARK IX.

includes also the reduced trunnion lever-type of antifriction mechanism in connection with the main trunnions. This is the first use of Belleville sprigs that the writer has observed in connection with a British railway mount. The total elevation attainable is 35.5 degrees, and the ratio of the gearing is one turn of the handwheel to 0.376 degrees of elevation.

257. *Traversing mechanism.*—Strictly speaking, this is a rolling type of mount, and the desired traverse is secured by operating it on a curved track. The mount is provided with car body traverse likewise to the extent of about 2 degrees—that is, 1 degree on either side of the center. The car body is rotated about the king pin of the rear truck by a traversing mechanism located on the front truck, Plate 121. This mechanism comprises suitable steel castings attached to the truck and car body, a set of six hardened steel rollers to reduce the friction of movement, and a traversing screw and nut. The screw is rotated by two handwheels through an epicyclic reducing gear. The ratio of the gearing is one turn of the handwheel for 17.45 seconds, or 0.00458 degrees of movement of the gun in azimuth.

258. *Gun carriage.*—The gun carriage is incorporated in the railway car body and is described briefly in the following paragraph:

259. *Railway car body.*—The railway car body, Plate 121, is made up of two structural-steel side girders joined by a series of structural-steel and cast-steel transoms. The girders are of quite peculiar shape and require an unusual amount of tedious and difficult bending of the chord angles. A loading platform of somewhat lighter construction is built on at the rear.

260. *System of anchorage.*—This mount being of the rolling recoil variety requires no platform or emplacing equipment. It is necessary to operate it on a curve to secure any great degree of traverse, but if the target is small enough and sufficiently accurately located the mount may be used on a section of straight track, especially prepared for the occasion, and the car-body traverse used for correction of fire. The curved or straight track so used should be made up of extra-heavy rails, long heavy ties, and a heavy bed of good ballast. Unless the track is thus well constructed it is likely to be pounded down to the extent of as much as from one-quarter to one-half inch per shot. The brakes are set hard for firing and the mount rolls back a distance of about 40 feet. It will be recalled here that all rolling mounts so far constructed have in addition a hydraulic recoil mechanism. This reduces materially the intensity of the shock transmitted to the track at any one instant and not only reduces the stressing of the carriage but the track as well. It is necessary to tamp up such a track after some use, for no matter how well constructed it will sink to a certain extent.

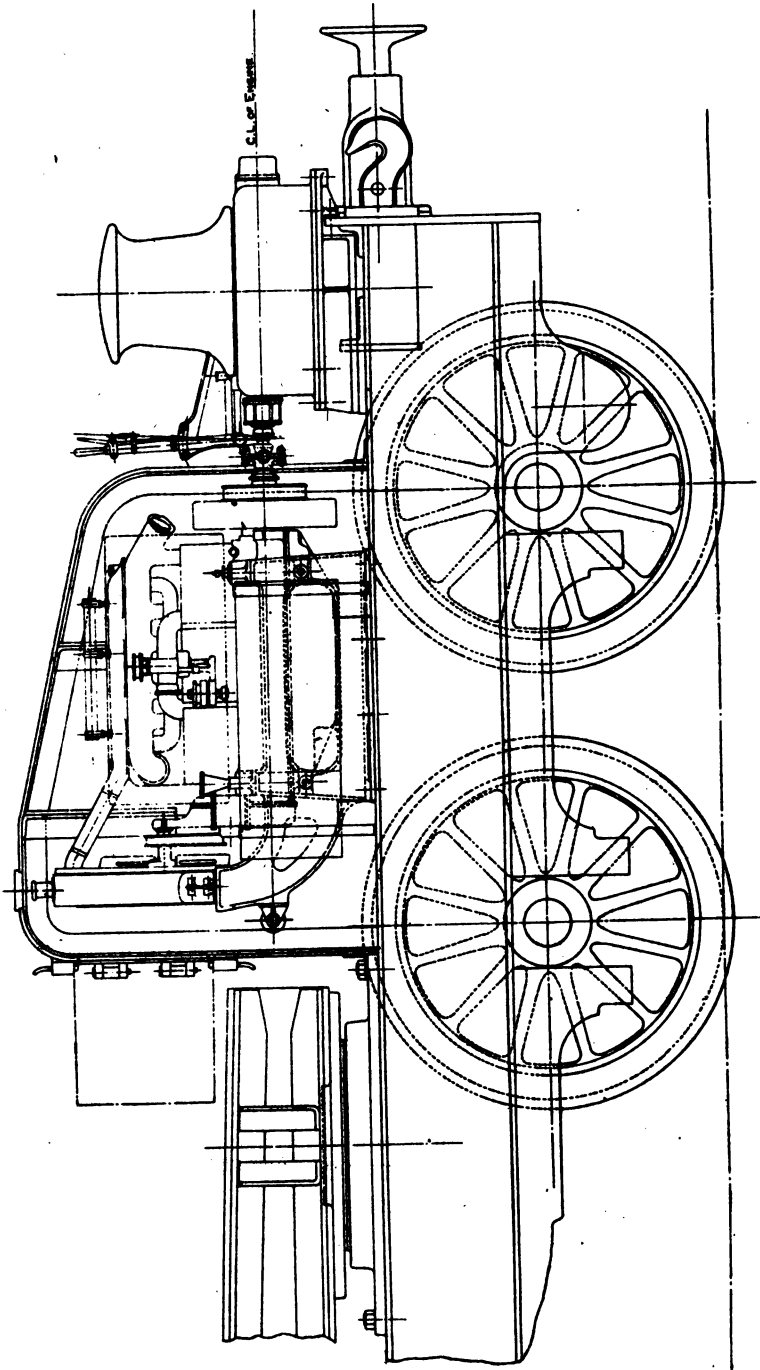

GAS ENGINE UNIT ON FORWARD TRUCK FOR TRANSLATING.

261. *Trucks*.—The mount is supported on four trucks, Plate 121, two front having four axles each and two rear having three axles each. The wheels are 45 inches in diameter, and the truck bodies are entirely of structural steel. The journals are of the objectionable inside variety. One brake shoe is provided on each wheel and the braking is done by hand only.

262. *Ammunition supply system*.—A shot truck built up of steel plates and angles, Plate 121, running on rails from the rear of the loading platform to the breech of the gun, is provided to transport the projectiles from the ammunition car to the gun. The truck is stopped and locked in its rear and forward positions by a spring bolt entering into sockets on the floor. This bolt is released by a foot pedal. The truck receives its projectiles from the overhanging trolley of the ammunition car; is run forward by two men, and locked in position with the forward end of the tray projecting inside the gun sufficiently to protect the threads. The projectile is held on the tray by a stop, which is drawn out of the way by a cam on the floor just as the lip of the tray enters the gun. The projectile is rammed by hand. A socket is provided in the floor several feet from the rear of the working platform where the shot truck may be locked in transit.

263. The ammunition car is of special design and carries 96 projectiles, arranged in 12 compartments, 6 on either side. Each compartment carries 12 projectiles, arranged in 4 tiers of 3 each; each tier is separated from the next by two wood spacers. The car is so designed that the ammunition can be supplied from either end. The car carrying the powder is coupled between the locomotive and the shell car and the bags of powder carried through by hand. A locomotive is required constantly while in action to run the shell and powder cars up to the mount and back again. The acceleration of the mount is too great to permit the men remaining on it when it is fired or to permit coupling the shell and powder cars to it.

12-INCH GUN (OLDER MODEL).

264. This mount is the first design made up for a 12-inch gun and served most valuable purposes in the Somme offensive of 1917 and in the general offensive of 1918. The writer observed one of these mounts near the one-time village of Dickebush, in Belgium, in March, 1918. It had been emplaced in that location for some time, being operated on a curved track, and was camouflaged as a huge manure pile by raffia nets spread out from the mount in all directions. Some of the very vigorous opinions of the officers in charge are now recalled with reference to the relative merits of spring and pneumatic recuperators. These men had had a good

long taste of the mud of Flanders and were in consequence 'decidedly opposed to any refinement or delicacy in the mechanisms that they were called upon to handle. This mount had spring recuperators.

265. *Gun.*—The gun is practically identical in design with that previously described. Its mounting in the cradle is different, hence minor difference in the exterior details. It is 40 calibers in length, is rifled at a uniform pitch to the right of one turn in 30 calibers, has 48 grooves, and operates at a service pressure of 36,000 pounds. The breech mechanism is of the interrupted-screw type, and is fitted with a percussion firing mechanism. The extreme range is 28,000 yards with an 850-pound projectile.

266. *Recoil mechanism.*—To the cradle are attached two hydraulic cylinders, about 15 inches in diameter, and two spring recuperator cylinders of about the same diameter. All of the cylinders are on the bottom of the cradle. It was somewhat of a surprise not only to find a mount of this size provided with these spring recuperators but likewise to find that the battery and group commanders and chief inspector of ordnance matériel of the army in which this mount was observed very decidedly preferred spring recuperators to pneumatic. It seems to have been their experience that, at least in the mud of Flanders, spring recuperators are easier to maintain than pneumatic. They reported that they had not experienced any serious difficulties in the use of this recoil mechanism.

267. *Elevating mechanism.*—To the bottom of the cradle is bolted an elevating arc of considerable length. This is the only mount of this size observed on which the elevating arc is attached at only one end. It projects down a considerable distance into the body of the car, where it meshes with a pinion on the horizontal shaft. It is possible to elevate the gun to about 30 degrees.

268. *Traversing mechanism.*—The traversing mechanism, Plate 124, of this mount is the one feature worthy of especial comment. It will be remembered that in the case of the 340-millimeter St. Chamond mount, when the mount is ready for action it rotates on a pivot in the center of the car, the trucks being removed and the front and rear ends sliding on steel plates. In the British mount the whole car body is made to rotate about the king-pin of the front truck as an axis. The traversing mechanism, Plate 124, is located on the rear truck. The center plate, which acts as a pintle or king-pin, is riveted onto the truck. On the top of this is a free block, A, capable of rotation about a vertical axis. In the top of this block is a groove in which are placed five steel rollers, B, and on the rear of the block is a rack, C, 24 inches long. To the body of the car is riveted another plate, D, which fits over the free block and rests on the rollers. To the rear of the car body are attached two bearings, E, carrying a

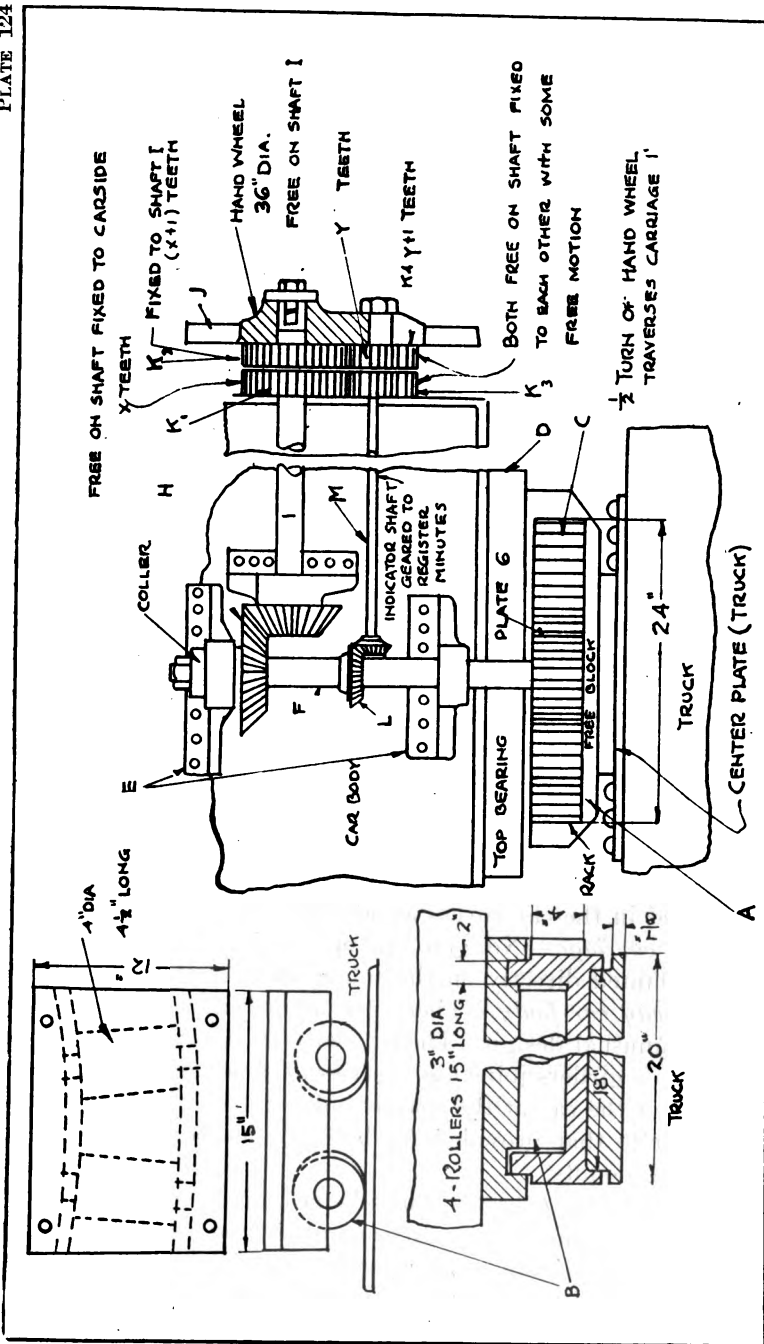

MOUNT TRAVERSING MECHANISM (PAR. 268).

vertical shaft, F, on the bottom of which is the pinion, G, which meshes with the traversing rack. At the top of this shaft is another pinion, H, meshing with the pinion on the shaft, I, leading to the side of the car.

269. A special handwheel, J, 36 inches in diameter and provided with differential gears, K₃-K₄, is placed on the end of shaft in preparing the mount for action. On shaft, I, are noted two gears, one of which, K₁, is fixed to the side of the car, and the other, K₂, is keyed to the shaft. On the handwheel are the other two gears, K₃ and K₄, both of which are free on their shafts but which are free to move with respect to each other only a short distance; that is, a pin on the side of the K₃ fits into a groove in the inside of K₄. These differential gears give a very slow but sufficiently rapid movement to shaft, I. One turn of the handwheel traverses the mount two minutes. The rack provided on the free block is of sufficient length to permit the mount to be traversed 1 degree on each side of center. All of the parts of this traversing mechanism were examined carefully for signs of wear, and none were discovered except on the differential gears, which had been worn considerably. On the vertical shaft, F, a second bevel gear, L, will be observed meshing with the gear on the small horizontal shaft, M, leading to the side of the car. On the end of the horizontal shaft is a pointer, and on the side of the car is a dial graduated in minutes. The approximate degree of traverse of the mount can be gauged from this dial.

270. It is necessary to fire this mount from a curved track to secure the necessary traverse to cover a target. The battery commanders report that when operating the mount on the curve the two degrees of traverse provided for in the mount have always been sufficient for their needs. At the maximum range of the gun the traverse provided in the car covers an arc of about 1,000 yards.

271. *Gun carriage.*—No gun or top carriage is provided. The cradle is mounted directly on the side girders of the car body.

272. *Railway car body.*—There are no features of this car body that are of unusual design. The car body is composed of two structural steel side girders joined by a series of structural steel transoms. On the top of the car at the rear is built a loading platform somewhat similar to that provided for both the 340 and 400 millimeter St. Chamond mounts.

273. *System of anchorage.*—The scheme of anchorage of this mount is the simplest employed with any mounts in the French and British Armies. As noted before, the mount is provided with an internal traverse of only 2 degrees. It is necessary hence to fire from a curved track as with all Schneider sliding mounts. It is significant, however, that no cross beams or sleepers are built into the body of the car as is true with the sliding mounts. In action the mount is moved

to the approximate firing position on the curved track by means of a locomotive and the gun accurately laid on the target by the use of the internal traversing mechanism. Before firing the brakes are drawn tight on both front and rear trucks and constitute the only means of absorbing the energy of recoil. On firing the mount runs back on the rails a distance of from 3 to 4 yards. It is returned to its firing position between each shot by means of the locomotive which is kept connected to the ammunition car a short distance away on the curve. No signs of injury could be discovered on the rear trucks as a result of permitting the full shock of recoil to come on the pintle and axles. The battery commanders and inspectors reported that they had never experienced any difficulty from excessive wear on the trucks or from breakage as the result of this scheme of anchorage. It was quite evident that the mount examined at Dickebush had seen considerable use and it was in most excellent shape. At the time that it was observed the mount was located on the curve from which it had been firing for some time. There was no indication from the condition of the track, which had been laid on about 8 inches of ballast on rather soft soil, that this scheme of anchorage was not satisfactory.

274. *Trucks.*—No features of these trucks are worthy of especial mention except possibly the connection already described which the rear truck has with the traversing mechanism. The front of the mount is supported on one 3-axle and one 4-axle truck. The rear is supported on a single 4-axle truck. The truck bodies are of structural steel and the axles have outside journals, are not equalized, and support the frames on helical springs.

275. *Ammunition supply system.*—On the rear of the loading platform a stand is built, on the top of which is a track capable of motion parallel to the length of the car to the extent of a yard or so. On the top of this track is a short truck, on which the projectile is placed from the ammunition car. In loading the gun is placed at zero elevation and the track run forward until it strikes the breech of the gun. The small tray carrying the projectile is then run forward and the projectile rammed by four men. The ammunition car inspected at Dickebush is identical in design with that described for the previous mount.

14-INCH GUN, MARK III.

276. This mount, Plate 125, marks the limit of development in the British Army during the World War, at least so far as construction is concerned, if not in design also. It was examined by the writer in May, 1918, at Sandwich, England, where it was awaiting transportation by ferry to France. It embodies several unique fea-

tures, namely, the use of balancing cylinders to permit of mounting the breech of the gun closer to the cradle trunnions and the use of separate and direct connected gas engines for elevating the gun, driving an air compressor, and driving the warping winch. These will be described in detail.

277. *Gun.*—The gun is a 45-caliber wire-wound gun, comprising two A tubes, the wire wrapping, a B tube, a jacket, a breech bushing, and a breech ring. It is provided with a breech mechanism of the interrupted screw type, operated by the continuous motion of a single handwheel. The firing mechanism is of the percussion type. The gun weighs 83 tons, and is rifled with 84 grooves at a uniform twist to the right of one turn in 28 calibers. The maximum range at 40 degrees elevation is 33,000 yards.

278. *Recoil mechanism.*—The gun is supported on a heavy steel casting called a slipper, which slides on the body of the cradle in recoil. To this casting are attached the pistons of the recoil and recuperator cylinders. The gun recoils a distance of 36 inches under full charge, and when elevated to 40 degrees it just clears the track at the end of the recoil. It can be seen from Plate 185 that the center of gravity of the gun is considerably forward from the center line of the trunnions. The gun has been so placed in order that it might be elevated to as much as 40 degrees and still have it clear the track at the end of its recoil.

279. The recoil mechanism comprises two hydraulic cylinders and one pneumatic recuperator. A recoil valve key in the wall of the cylinder regulates the rate of flow of the liquid past the piston. Only one such key is used. It can, of course, be compared with the throttling bars used on many American recoil mechanisms, but its operation is somewhat different. The valve which is operated by this key is installed in the piston head. There is no buffer on this cylinder such as is ordinarily found on cylinders used on American carriages. On Plate 125, just over the forward truck, will be noticed an air compressor, which is used in charging the various tanks, one series of which will be noted over the rear truck and another series in the body of the carriage just behind the last wheel of the front truck. From these tanks air is supplied both to the pneumatic recuperator and to the balancing cylinder. The air compressor just noted is driven by a 15-horsepower gas engine.

280. *Elevating mechanism.*—The elevating mechanism comprises two screws approximately 5 inches in diameter, both being driven by a common shaft from a 15-horsepower gas engine located in the body of the carriage just above the rear wheel of the front truck. The shaft running from the engine is connected with the two shafts and drives the screws through the clutch, operated

from the outside of the carriage on the left side. This is a friction clutch and permits of quite rapid elevation and depression. On each screw is a crosshead which is connected by two links to the cradle at the bottom and rear. In connection with this elevating mechanism a balancing cylinder is used to overcome the very considerable muzzle preponderance resulting from mounting the gun with the center of gravity forward of the trunnion axis. This balancing cylinder is approximately 12 inches in diameter and 9 feet long. To the piston projecting from its forward end is attached a crosshead which is connected by two links to the cradle at the rear. In this cylinder an air pressure of approximately 1,100 pounds per square inch is maintained, and the effort on the screws required to elevate the gun is reduced to the capacity of the 15-horsepower engine or to the capacity of four men operating a slower gear by means of handles. This system of balancing can not be considered perfect, and there are many places in the 40 degrees elevation over which the engine has difficulty in moving the gun.

PLATE 125

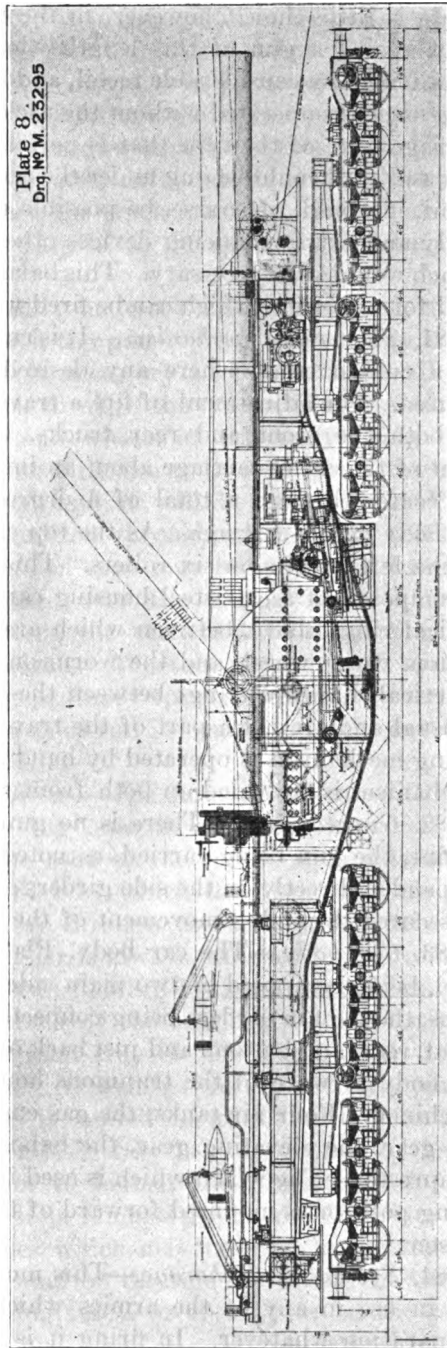

There is little choice, however, in the mechanism that may be used in balancing a gun of this length when it is mounted on a cradle permitting any considerable recoil, and the whole is mounted on a carriage which is operated without the use of the firing platform. If the carriage were of the type that is permanently fixed in any one position and a pit could be dug under the center into which the gun might recoil, it would, of course, be possible to balance the gun more perfectly and extra balancing devices other than counterweights on the breach would be unnecessary. This balancing device is the price that is paid for a carriage which can be fired without any track preparation.

281. *Traversing mechanism.*—It is customary to operate this mount on a curved track where any desired degree of traverse may be secured. For adjustment of fire a traversing mechanism is provided on both the front and rear trucks, which permits of the movement of the entire carriage about an imaginary vertical axis through the center through a total of 4 degrees. The rack is attached to the body of the carriage. As the top carriage is moved to the right or the left it rolls on six rollers. This traversing mechanism hence is composed of a cast-steel housing carrying the six rollers, the two conical rings above, between which are the conical rollers, the rack, pinion, worm wheel, and the worm on the right of the truck. The spherical-shaped castings between the bolster and the truck are not unusual and are not a part of the traversing mechanism. The traversing mechanism is operated by hand and, as noted above, the same mechanism is provided on both front and rear trucks.

282. *Gun carriage.*—There is no gun carriage provided with this mount, the gun being carried, as noted before, in a cradle which is suspended directly on the side girders of the car. Any traverse must be secured through a movement of the entire car body.

283. *Car body.*—The car body, Plate 125, is made of structural steel, being composed of two main side girders, each containing two webs, these main girders being connected by suitable transoms at the front, rear, and bottom, and just back of the gun. The portion of the car body forward of the trunnions houses a considerable amount of machinery: Four air tanks, the gas engine, which drives the elevating gear, the elevating gear, the balancing mechanism, and the air compressor. The winch which is used in returning the carriage to its firing position is mounted forward of the center bearing of the front bolster.

284. *System of anchorage.*—This mount is one of the few at present in use in any of the armies which is fired without any track preparation whatever. In firing it is the custom merely to set the brakes, thereby taking up in friction as much of the energy of recoil as possible. The carriage runs back on the rails a distance of from

30 to 40 feet. It is returned to its firing position by means of the winch, Plate 125, carried on the forward end of the carriage, a cable being attached to the rail some distance in advance of the firing position. The firing curves inspected by the writer were somewhat heavier than those ordinarily used with other types of artillery. Inasmuch as the mount is operated on a curved track, there is a tendency, of course, to displace the track laterally, since there is a very considerable component parallel to the ground and normal to the track.

285. *Trucks*.—It can be readily understood that the trucks for a mount of this type, from which the gun is fired without any track preparation and in which it is necessary to communicate all the stresses of firing into the track through the trucks, it is essential to provide truck frames, axles, and wheels of extremely heavy construction. The springs are unusually heavy in order that they may withstand the shock of firing, and it will be observed in Plate 125 that the springs are equalized throughout on each truck in order that the stresses brought on each may be uniform. In addition to the leaf springs carried over the journal boxes of each axle, helical springs are used on the vertical bars connecting the springs with the equalizing levers. Whether these helical springs are required in addition to the ordinary springs because of the type of the carriage it is not known, since full information on the development of the mount is not available.

286. *Ammunition supply system*.—The ammunition car with this mount is an all-steel car, having bins on each side in which are carried 96 projectiles. To the roof of the car on each side is attached a track carrying a trolley by which the projectiles are carried from any part of the car through the end doors where the tracks meet. The ammunition car is always attached to the locomotive, and in loading the car is run forward to the mount. When the trolley is at the end of the track of the ammunition car the projectile may be placed on the shell tray on the track. This track moves on three sets of rollers. As soon as the projectile is placed on the shell tray the track is moved forward until it touches the breech of the gun and the shell tray is run forward by hand, acquiring sufficient momentum to launch the projectile into the powder chamber from which it is rammed by hand. On Plate 125 also will be noted two winches which may be used in picking up projectiles either from the ground on the side or rear of the car or from other cars on an adjoining track, or at the rear on the same track.

287. *Maintenance*.—Those who have operated this mount as well as the 12-inch mount of a similar design report that they have comparatively few difficulties. Difficulties are, of course, to be expected

with the gas engines, some difficulty with the air compressor, and likewise some difficulty with the balancing cylinder. The recoil and recuperator cylinders require only the attention of the average mechanism of this type. No difficulties have been reported on the trucks from unusual stresses, although one would expect that broken bearings or bent journals might be the result of long-continued firing.

288. *Difficulties involved in the service.*—No especial difficulties have been reported by those who have operated this type of mount. As noted before, the foundation of the track must be very heavy. The elevating mechanism does not operate smoothly and the engine that was first mounted in the carriage was not of sufficient strength. An engine of double the original capacity is now in use and to date is operating successfully. There are several points in the 40 degrees of elevation over which the gun does not move smoothly. As noted before, however, this type of balancing mechanism is probably one of the best that can be used and is the price that one pays for a carriage which is to be operated without any track preparation.

289. *Merits.*—The ammunition car, loading mechanism, and traversing mechanism are all of excellent design. The loading mechanism throughout is simple, easily maintained, and easily operated. The ammunition car is simple, sturdy, and efficient. The traversing mechanism gives a degree of traverse ample for all ordinary purposes and at the maximum range of the gun at 40 degrees elevation, which is 33,000 yards, covers an arc of about 500 yards. The general design of the mount resulting in an elimination of the necessity for a firing position, may likewise be considered a merit inasmuch as no firing platforms and nothing unusual in the way of track preparation are required. The mount itself with its ammunition cars and locomotive constitute the entire equipment required and it is ready for action always in a minimum of time. In comparing this mount with a mount of the Schneider sliding type for a gun of the same caliber with which it would be necessary to place on the track a very simple type of firing platform composed of H sections, it is realized, of course, that this mount has the slight advantage of requiring no platform at all. It should be remembered, however, that the Schneider type of mount does not require the manufacturing facilities required on the Armstrong mount for the manufacture of the cradle, recoil mechanisms, balancing cylinder, and air compressor.

290. *Demerits.*—There is no special feature which may be considered a demerit, although the balancing mechanism is not perfect. As just noted above, there is a question as to whether one is warranted in using the manufacturing facilities required for producing cradles, cylinders, balancing mechanisms, etc., for a mount of this type for

field service, when the gun mounted on a Schneider sliding type of carriage can be operated just as rapidly, and the sliding type of carriage requires much fewer facilities for its construction. The controlling factor in the speed in which the mount may be served is the time required for loading the gun. In either this type of mount or the sliding type of mount it is possible to return the carriage to the firing position and lay it accurately in less time than it is possible to load the gun.

ITALIAN AND AMERICAN RAILWAY ARTILLERY. ITALIAN 381-MILLIMETER GUN.

291. This mount, Plates 126-127, is a combination of the cradle and sliding recoils, embodying likewise limited car-body traverse and semi-automatic elevation and depression. To the best of our knowledge it is the only railway-mount construction for the use of the Italian Armies and was made by the Ansaldo Co. In certain

PLATE 126

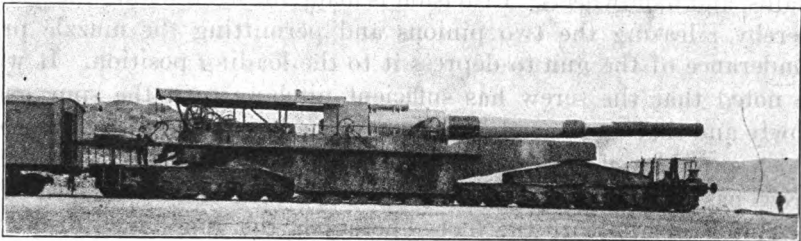

ITALIAN 381-MM. GUN RAILWAY MOUNT.

respects it must be considered crude, in that it does not indicate the familiarity with the more recent developments in the design of railway artillery shown on certain French and American mounts. It must be remembered, however, that there was little occasion for the use of such artillery in the Italian Army and hence little to be gained by devoting meager design and manufacturing resources to its development.

292. *Gun.*—The gun is a built-up piece of 40-caliber length and fitted with an interrupted screw-breech mechanism of the Welin type, Plate 132. The firing mechanism apparently permits of the use of electric primers only. The breech of the gun is provided with a heavy counterweight, to which the various recoil and recuperator pistons are attached. Apparently the designers were not able to provide space for sufficient counterweight to allow of a very satisfactory elevation.

293. *Recoil mechanism.*—The gun is mounted in the ordinary type of cradle provided with four hydraulic buffers and two pneu-

matic recuperators. The length of recoil at maximum elevation is 48 inches. It will be observed that the gun is of such length that even after it is heavily counterweighted it is possible to secure an elevation of only 25 degrees. Under each trunnion there is provided an antifriction device, which, in effect, is the same as the antifriction device used on most of the Schneider-type mounts. The recuperators are of the same design in essential details as those used on British 8-inch field howitzers. The liquid is in constant contact with the air and on recoil is forced up through the connecting tube into the air reservoir. The recoil buffers are of interesting design, containing a somewhat original use of a single throttling bar of varying section attached to the front end of the cylinder and sliding within the hollow recoil piston rod. The liquid passes through a series of ports in the rear end of the head and then out around the throttling rod.

294. *Elevating mechanism.*—On Plate 127 is shown the elevating mechanism, which is composed of the main screw connected to the bottom and rear of the cradle, the spur gear, pinions, shaft, clutch, chains, and handwheels. Provision is made for unclutching the shaft, thereby releasing the two pinions and permitting the muzzle preponderance of the gun to depress it to the loading position. It will be noted that the screw has sufficient pitch to turn the spur gear slowly and that on the end of the screw is a heavy nut with a washer, which provides a stop against the heavy block through which the screw passes. The depression is thus obtained simply by pressing the clutch treadle with the foot, whereupon the gun slowly drops to the loading position. The steel block carrying the spur gear is suspended by means of trunnions between the structural-steel side girders shown on Plate 127, lower view.

295. *Traversing mechanism.*—Inasmuch as the cradle carrying the gun is suspended directly on the side girders of the carriage it is, of course, necessary to operate the carriage on a curved track to secure any considerable degree of traverse. For finer adjustment, however, a traversing mechanism is provided over the rear truck. It will be noted in Plate 127 that this traversing mechanism over the rear truck consists of two handwheels communicating by means of chains to sprockets on a heavy screw provided in the top carriage. This screw passes through the lug on the traversing beam or bolster. It will be noted that the top carriage is supported on the top of the traversing beam on 12 rollers and that the traversing beam is supported on the top of the truck by means of 11 conical rollers on each side. With this traversing mechanism it is possible to secure a traverse of a total of 2 degrees, 1 degree on each side of the center.

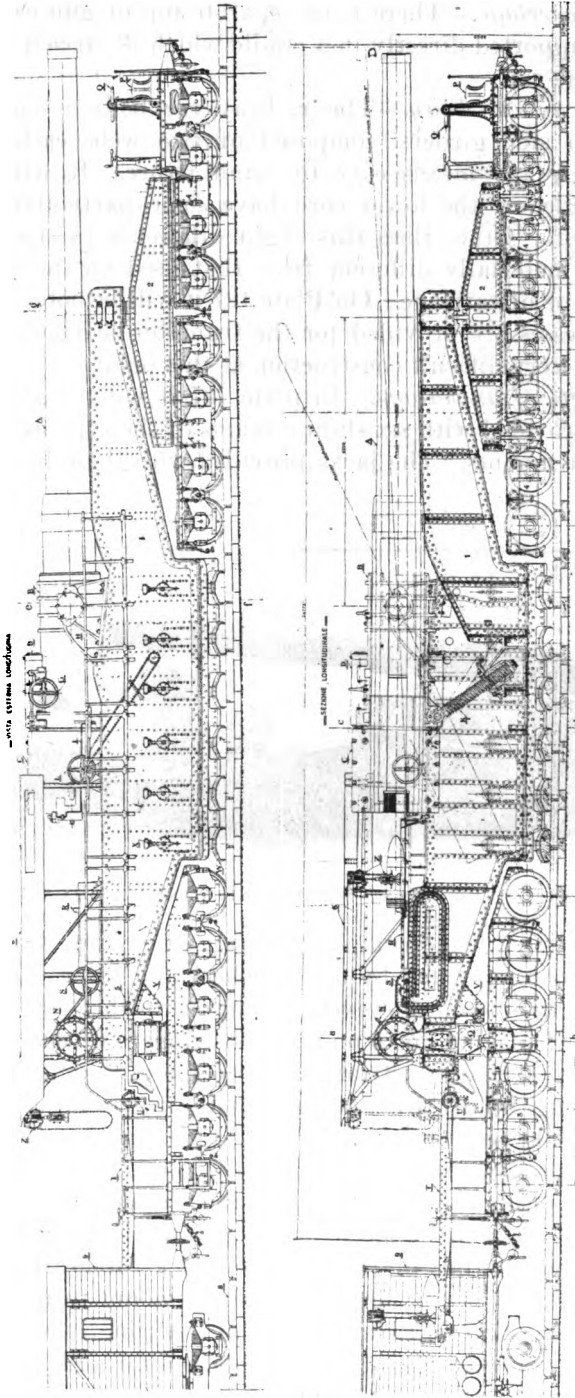

RIGHT ELEVATION AND LONGITUDINAL SECTION OF 381-MM. GUN MOUNT (ITALIAN) ON FIRING PLATFORM.

296. *Gun carriage.*—There is no separate top or gun carriage, the gun being supported directly in a cradle which is carried on the side girders of the car.

297. *Railway car body.*—The railway car body is composed of two built-up side girders, composed of two webs each and of a profile not by any means easy to manufacture. It will be noted that the angles of the lower cord have some particularly difficult bends in them. Other than this slight difference in shape, the car body is not materially different from that used on the well-known Schneider type of carriage. On Plate 127 it will be noted that on the top cord recesses are provided for the trunnion bearings. This has resulted in a very difficult construction at this point.

298. *System of anchorage.*—In plate 127 it will be seen that this carriage is provided with six sliding beams of the type usually found on Schneider mounts. The jacks provided with these beams are not

PLATE 128



TRANSLATING MOUNT WITH HAND WINCH AND CABLE.

unusual in design, being composed simply of a screw and two bevel gears, the whole operated by a handwheel and lever. The method of operating the mount, however, is unusual in that the Italians are in the habit of placing down on the ties stringers of wood instead of steel, thereby securing a friction of wood on wood. The bottom of the jacking beams are not shod with iron and it is assumed that they would wear quite rapidly. It is necessary, of course, to raise the jacks between each shot, and the carriage is returned to its firing position by means of the translating mechanism located on the front truck. This hand mechanism operates the capstans shown, Plate 128, about either of which is wound a cable attached to the track in front. It is possible to return the mount to its firing position in less time than is required to load the gun. The final adjustment in laying the piece is, of course, obtained through the traversing mechanism explained above. On firing, the mount recoils on the track a distance of about 1 meter.

299. *Trucks.*—In Plate 127 it will be observed that both the front and rear trucks are made up of structural-steel frames and that the axles have outside journals. At the front a structural-steel bolster is provided connecting the two 4-axle trucks. Hand brakes are provided on both the front and rear. In front the axles are equalized in pairs and at the rear in sets of three.

300. *Ammunition supply system.*—The ammunition car provided, Plate 129, is apparently a standard box car modified to the extent of being installed with interior equipment in the nature of an overhead trolley and end doors as well as side doors and shell racks. Each car is capable of carrying 29 projectiles in the center of the car and the powder charges for these 29 rounds. An overhead trolley is provided, with which it is possible to carry the projectile to either end of the car. Near one end of the car, Plate 130, is provided a support on which one end of the structural-steel ammunition transfer beam rests. On this beam is shown the tray on which the projectile is placed and which is moved forward by means of a chain operated by a hand-wheel at the forward end. When the projectile reaches the forward end of the transfer beam it is picked up by means of the chain hoist on

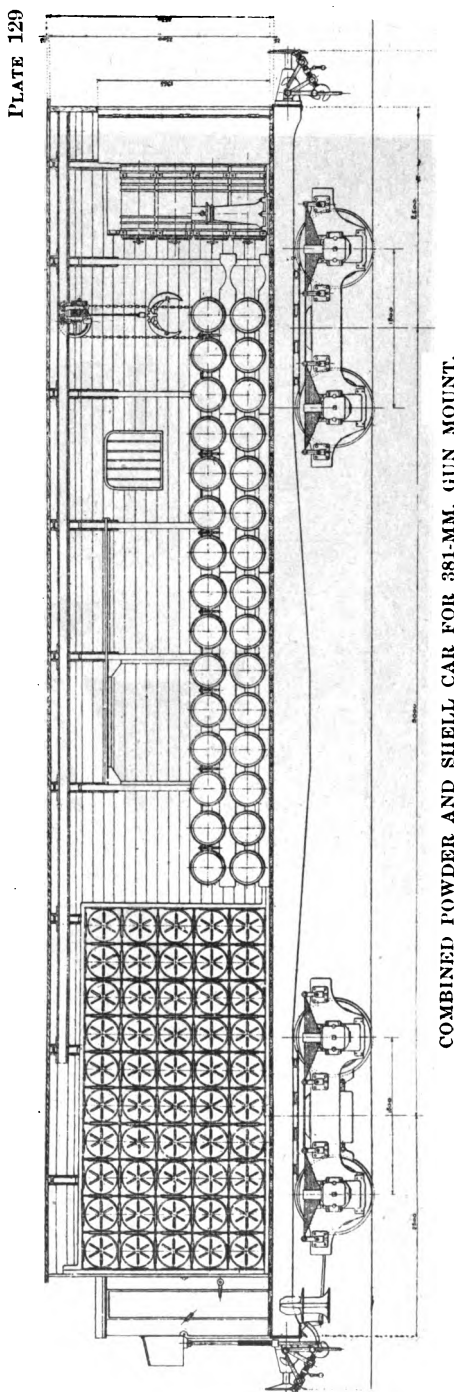

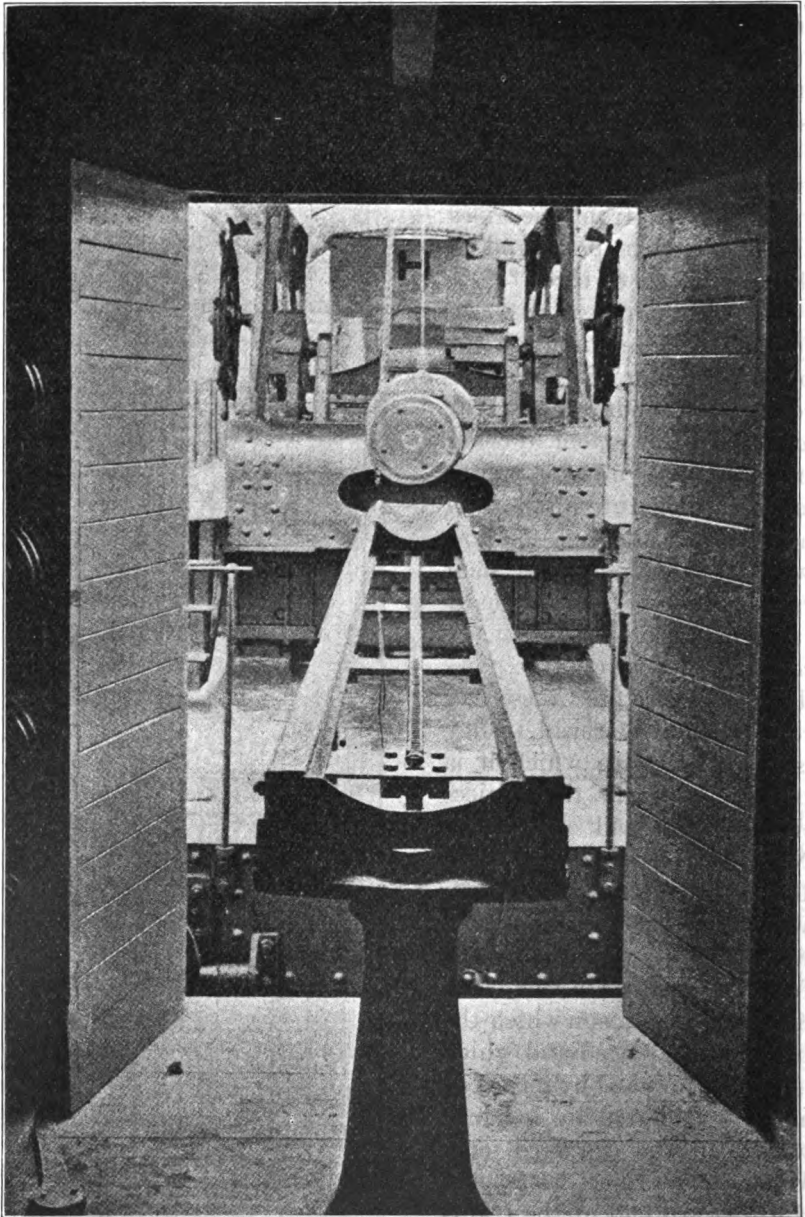

AMMUNITION TRANSFER BEAM.

the trolley attached to the armored roof, Plate 131, and is thence transferred forward to the ammunition table. From here it is rammed mechanically by means of the flexible chain, Plates 127

PLATE 131

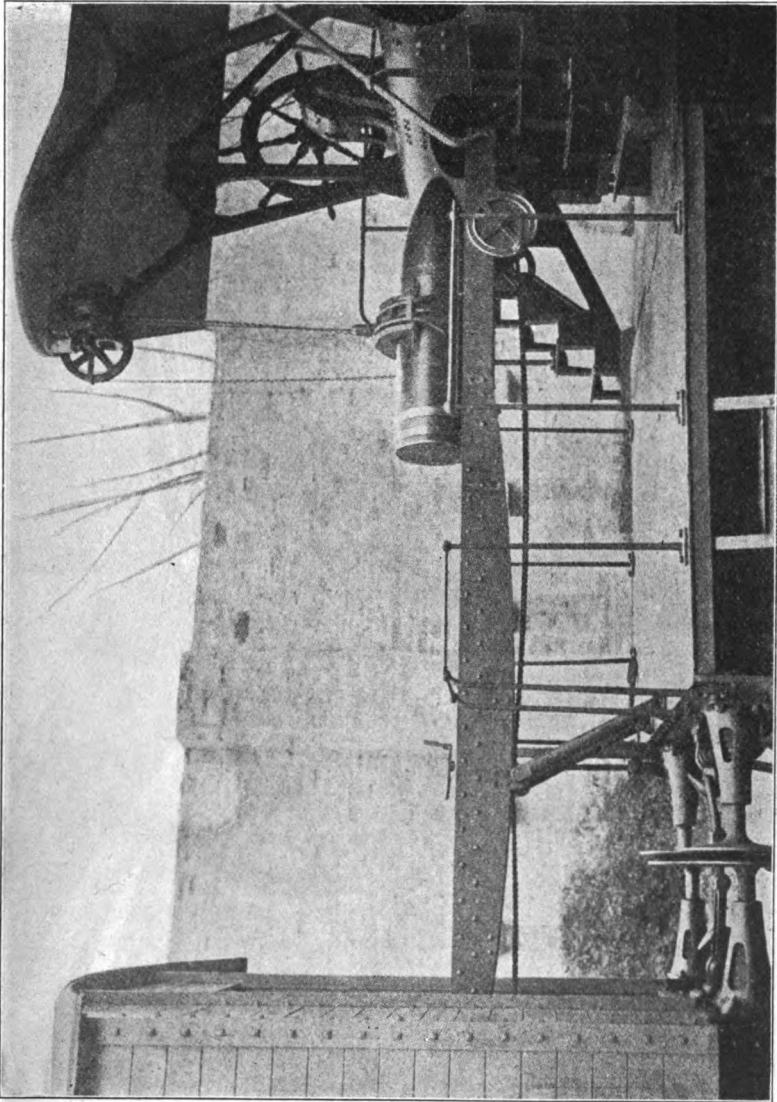

TRANSFER BEAM AND SHOT HOIST FOR 381-MM. GUN MOUNT.

and 132. The ammunition car is kept attached to the mount while firing.

301. *Maintenance.*—No information was received with reference to any difficulties involved in the maintenance of this mount. It is

assumed that no more care is required than is necessary for the usual sliding type of mount. It was noted above that it is the practice of the Italians to operate with wood stringers. This, of course, entails

PLATE 132

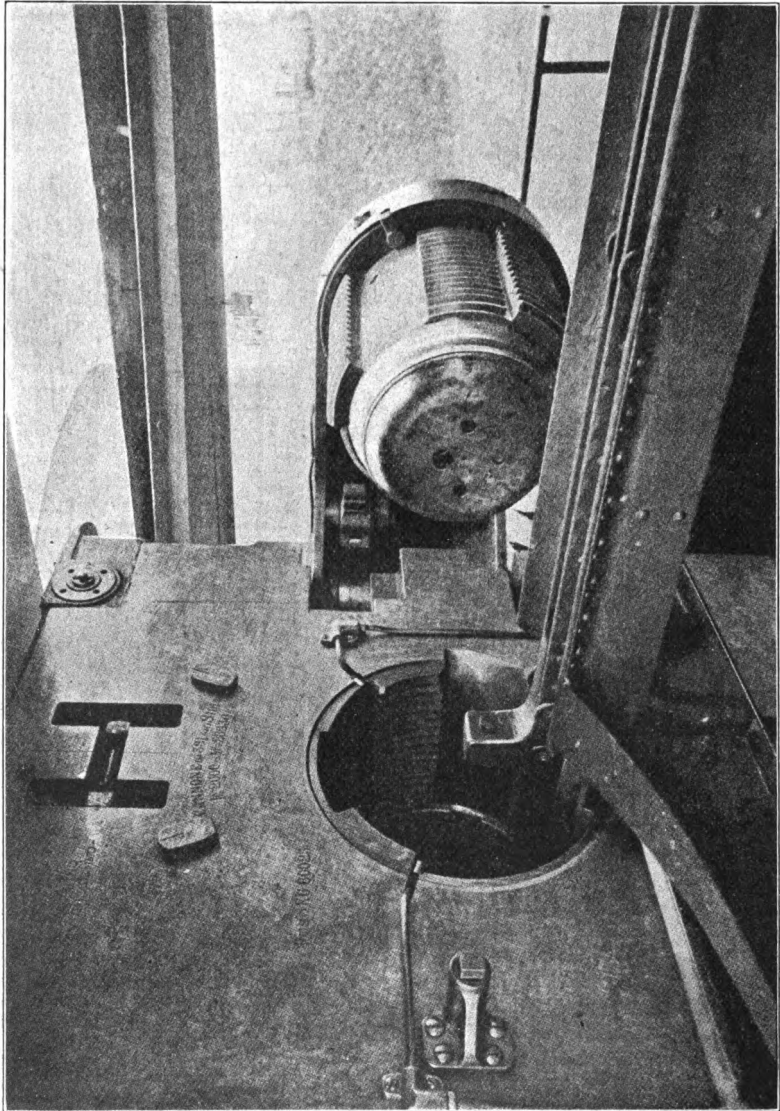

BREECH END OF GUN WITH CHAIN RAMMER ENTERING SCREW BOX.

a much more rapid wear on the sliding beams than would be the case if the beams were shod with iron and were operated on steel stringers. It is not known why they have adopted the practice of using wood stringers.

AMERICAN 14-INCH GUN ON RAILWAY MOUNT, MODEL 1920.

302. So many of the more admirable features of modern railway mounts have been combined in this mount, Plate 133, and an attempt has been made to meet so many of the needs of the field railway and the coast artilleryman that one can not grasp them all without a full and careful examination of every detail of the design.

303. In field warfare the artilleryman desires a mount, whether it be light or heavy, that requires a minimum of shifting about and adjusting while it is in action. He prefers to avoid the heavy sub-track platforms of the French 340 and 400 millimeter mounts and even the track platforms of the American 8-inch mount or the Schneider sliding mounts, if possible. He wishes to obtain his supply of ammunition as easy and rapid as possible. Further he desires the reactions on his track to be as easy as possible, for otherwise he has the choice of installing a superheavy track or of having his standard track pounded out of shape quickly. On the other hand, the coast artilleryman requires certain features and desires many more. He requires a mount that will permit the gun to follow a moving target with absolute uniformity until the moment of firing. He requires quick and easy loading arrangements, quick and easy schemes of installing the mount on its firing platform, the extremes of elevation, and a rapid and easy operating elevating mechanism. All of these requirements and desires have been very admirably met in this design.

304. *Gun.*—This gun is similar in design with the 14-inch American Navy guns used on the Mark I and Mark II mounts described under paragraphs 225 and 240, vol. 1. It is a 50-caliber built-up gun, rifled at a uniform twist, viz., one turn in 32 calibers. The breechblock, Plate 134, is of the Welin thread type, being divided into 16 sectors, thereby requiring only one-sixteenth of a turn to release or secure it. The gas check is of the DeBange system. When the block is released it falls open of its own weight and is stopped by a buffer spring; the spring rod, Plate 135, is likewise the piston of the pneumatic closing cylinder. A percussion firing mechanism is employed, Plate 136. The breech end of the gun has been provided with a heavy cast steel, lead filled counterweight, which has enabled the gun to be mounted about 3 feet farther forward than the same guns on the Navy mounts, Marks I and II.

305. *Recoil mechanism.*—The recoil mechanism provided for the guns used on these mounts is unique for railway mounts. It was mentioned in paragraph 303 that the field artilleryman desires a mount that will require a minimum of adjusting while in action and on which the recoil has been made sufficiently easy to prevent the pounding out

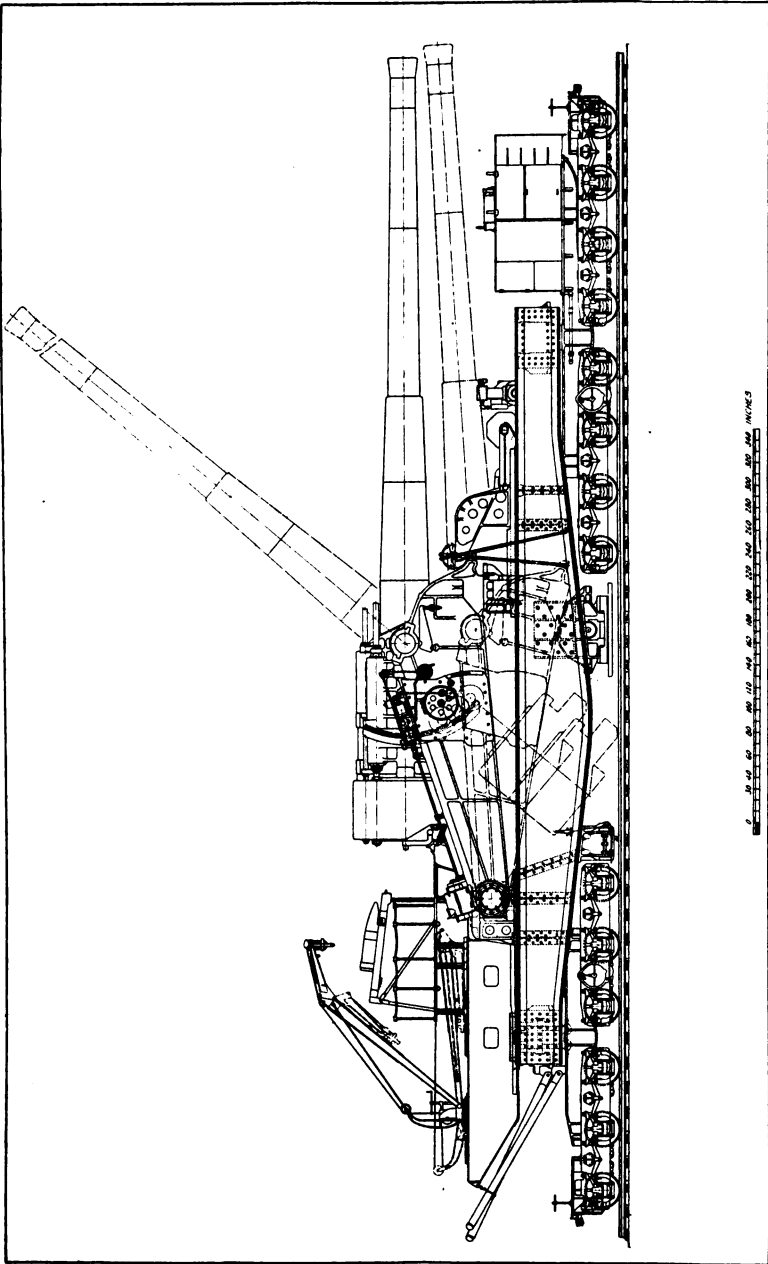

RIGHT SIDE ELEVATION OF 14-INCH GUN RAILWAY MOUNT, MODEL OF 1920.

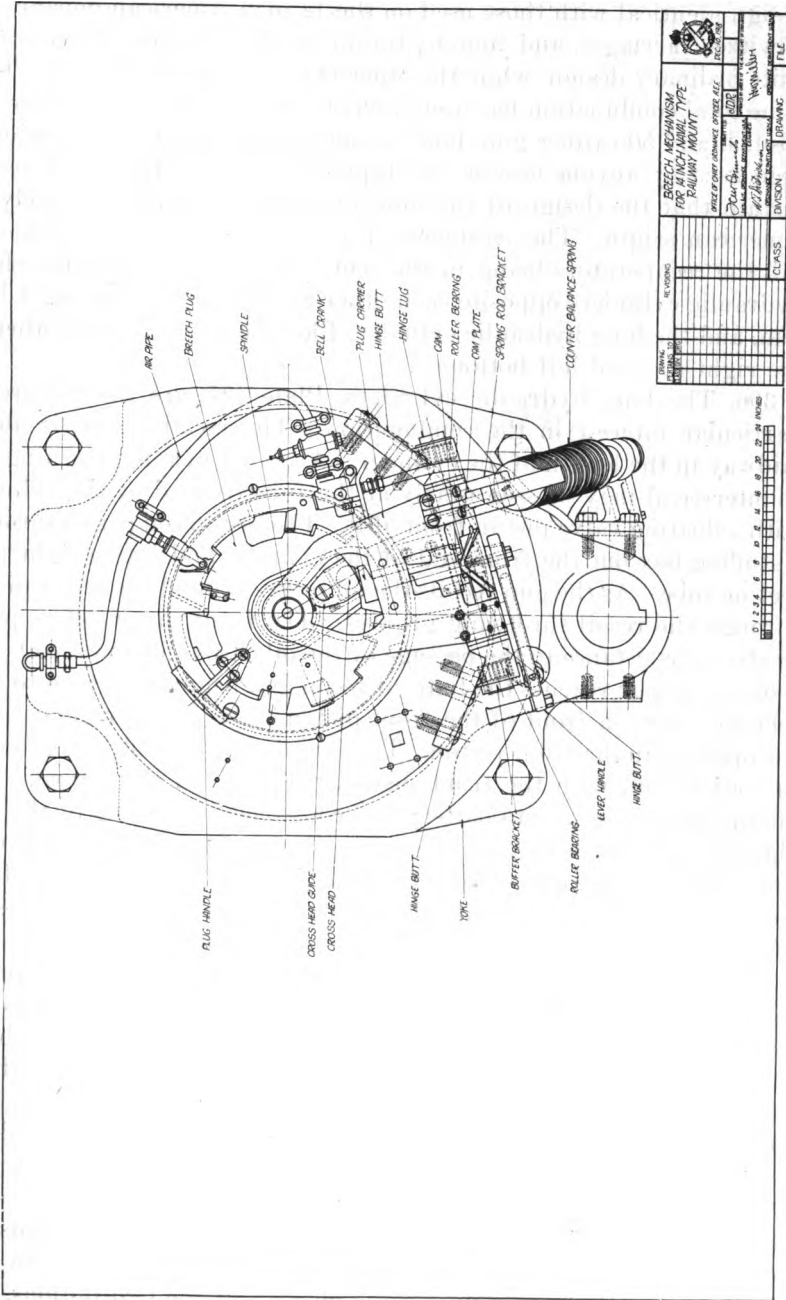

of shape of his track. This recoil mechanism, Plate 137, seems to fill those requirements. It comprises two pneumatic recuperators of a design identical with those used on the 12-inch American mortar and howitzer carriages, and four hydraulic buffers, two of which are of quite ordinary design, while the other two are equally unusual. This same total combination has been used on the barbette carriage for the 16-inch and 50-caliber gun, but has not to the best of our knowledge been used by anyone else on any type of carriage. In fact, it seems certain that the design of the long hydraulic cylinders is purely of American origin. The arrangement of cylinders is purely symmetrical, the recuperators being in the center above and below, the short hydraulic cylinders opposite each other at the left top and right bottom, and the long hydraulic cylinders likewise opposite each other at the right top and left bottom.

306. The long hydraulic cylinders, Plate 137, are the feature of particular interest in the combination. The recoil piston is about midway in the length of the cylinder. A second piston governing the counterrecoil may be seen nearly at the forward end of the cylinder with a floating valve just in front of it. The piston rod passes through a stuffing box out the front end of the cylinder and into a light protecting tube. As the gun recoils the oil passes around the recoil piston through the recoil throttling grooves. The front piston offers practically no resistance to the passage of the oil through it on recoil. As soon as the gun reaches the limit of recoil and begins to return to battery the valve in front of the front piston slides rearward and closes the opening in the front piston. The counterrecoil throttling grooves, in conjunction with the front piston, then control the return. The bumping of the gun into battery and consequent vibrating of the carriage at low angle fire, which ordinarily would result from having a recuperator pressure sufficiently high to function at extreme elevation, is thus eliminated entirely. This is certainly the best design of counterrecoil buffer that the writer has seen to date.

307. *Elevating mechanism.*—The elevating mechanism comprises an electric motor, Plate 138, which drives through spur gears the shaft leading to the Waterbury speed gear. This gear in turn leads through a vertical shaft and bevel gears to the middle pinion of the three seen along the inner circumference of the rack. This pinion meshes with the two gears on either side of it, which in turn drive the two pinions which mesh with the rack. This is another departure from the usual design. In all other designs involving only spur gears there has been only one pinion in mesh with the rack. This has brought all of the strain of the firing load on one tooth. In this design two teeth are in contact, one on each of the two pinions, and in turn the strain is transmitted to the central pinion, likewise through

two teeth, thereby doubling the capacity with only a slight increase in the number of gears.

308. An additional feature is embodied in the design of the elevating mechanism in what might almost be called an automatic elevating and depressing arrangement. Before operating the elevating mechanism the operator releases by a hand lever a brake band clamped about a drum by means of a spring, the drum being attached to the fast-moving pinion of the elevating gearing. When the band is clamped, the gun is held in position, but not so rigidly as to prevent the slight slipping frequently necessitated by the whipping of the gun. The gun and cradle are so balanced as to give a breech preponderance when loaded and a muzzle preponderance when empty. If the brake band is unclamped when the gun is loaded the breech preponderance is such as to quickly and easily elevate the gun almost to the proper setting. Again, if the gun is elevated and empty it will quickly descend to its loading position on the release of the brake, and a start being given to the elevating handwheel. The carriage also is equipped with a speed gear and electric motor for fast operation of the elevating movement. Provision is made, of course, for hand elevation in the event of failure of the motor. The handwheel is seen on the right side of the gun carriage in conjunction with the three driving gears and pinions.

309. An antifricition device of a design slightly different from those previously used is incorporated in this carriage. The beam and Belleville springs, seen just under the trunnions, Plate 139, are not unlike the beams and springs used on the sliding carriages. The friction is reduced, however, through the use of a roller bearing instead of a reduced trunnion. This roller bearing on the extension of the trunnion comprises 16 rollers, each 1 inch in diameter by 4.125 inches long and held in a cage carefully machined to keep the axes of all of the rollers parallel. This cage rotates within the outer shell of the bearing, which is in turn supported on the beam. The end of the beam is screwed up until the trunnion is free of the main trunnion bearing. The gun is then oscillating on the rollers and with a minimum of friction. It was found on test of a similar bearing (for 16-inch barbette) that the coefficient of friction was 0.002, even when loaded to the extent of 800,000 pounds.

310. *Traversing mechanism.*—This mount is provided with top-carriage traverse to the extent of 7 degrees, and car body traverse to the extent of 360 degrees. The first-mentioned mechanism is provided for final adjustment of the gun in azimuth when it is being used against a field or fixed target. The second is provided for use when operating against a moving target, although it can, of course, be used in connection with a fixed target when the mount is emplaced on concrete or on a portable field base plate. Both

mechanisms are unique in connection with our own railway mounts. The first is especially unique, for to the best of our knowledge it has not been used by anyone else on any type of mount. The second has been used on numerous German railway mounts.

311. The top-carriage traverse is unique in that the pintle is at the rear instead of at the front. Some unique features of the design of the top carriage will be described under that heading. A few of them must be mentioned here likewise, since they are a part of the traversing mechanism. The top carriage swings in a vertical plane about an axle at the rear, Plate 133, which in turn passes through a steel casting that rotates in a horizontal plane about vertical trunnions having bearings in a heavy bracket or housing attached rigidly to the car body. The forward end of the top carriage, when the mount is in transport, travels low between the side girders, Plate 133, and is raised to a higher position before it can be traversed, as shown on the same plate. When the forward end is raised a supporting beam, which is carried in a forward position during transport, is moved to the rear a short distance and the carriage lowered until the two conical rollers mounted in the side frames rest on the beam. The top carriage may then be traversed about the vertical trunnions at the rear by means of a screw-operated slide passing across the front of the top carriage, Plate 140. The supporting beam has at its center a lug which engages with the slide at front end of top carriage, forcing the front of the carriage to move to the right or left as the screw is turned. This mechanism gives a total traverse of 7 degrees and is provided for use only in field warfare, where the mount is initially placed in the proper position and only sufficient traverse for correction of fire is required. The carriage is locked in its central position when the gun is being operated against a moving target by means of the second and wide traversing mechanism.

312. The second traversing mechanism, Plate 141, comprises a ball-bearing pedestal swung between the side girders of the car body by means of trunnions and two motor-driven rollers 15 inches in diameter mounted in the car body just in front of the rear trucks. An emplacement is necessary in connection with this mechanism. The emplacement is quite simple, comprising merely a small base plate fastened to the concrete with anchor bolts in the center over which the base of the pedestal fits and a circular track on which the two rollers rest. The car body in transport travels 5 inches high. By this it is meant that it is possible to lower the car body 5 inches by means of what may be termed car body elevating mechanisms, which are incorporated into the car body at the front and rear over the king pin of each span bolster. These mechanisms are identical

PLATE 140

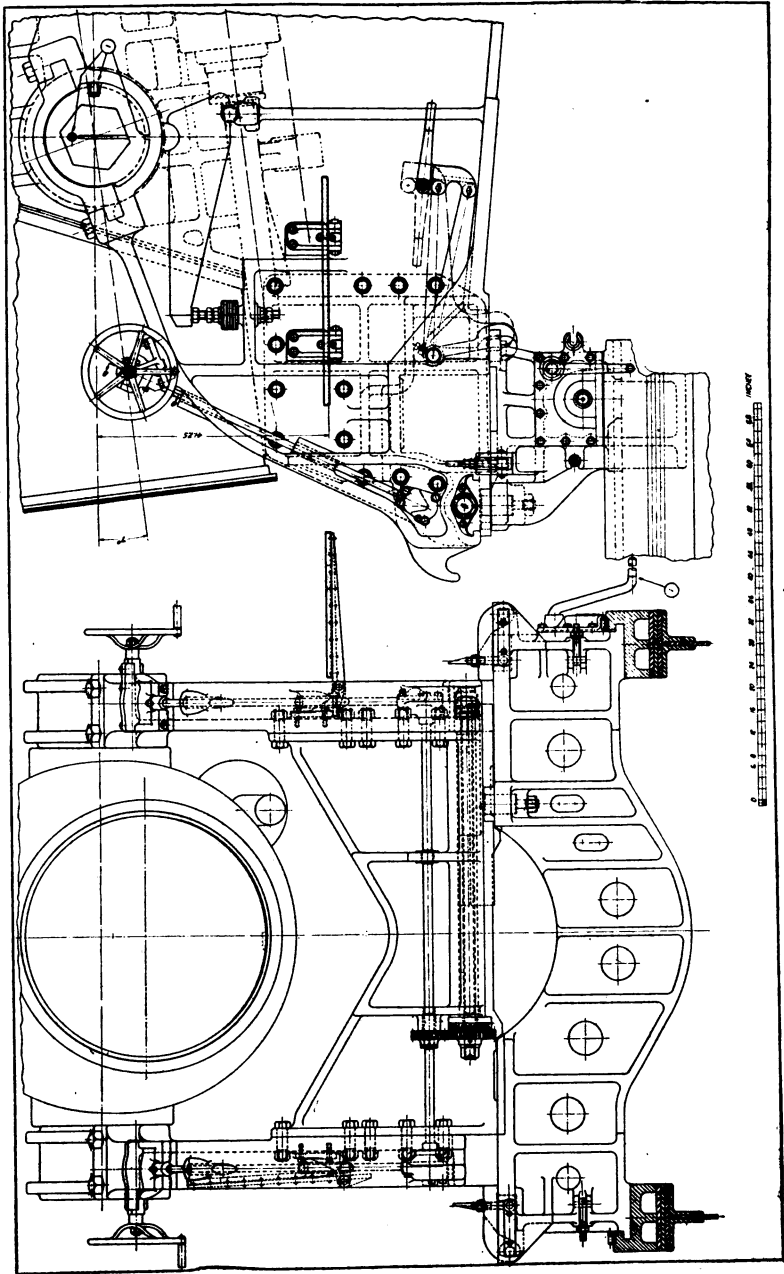

TOP CARRIAGE TRAVERSING MECHANISM ASSEMBLY.

with a similar mechanism used on the 14-inch mount, Model E, No. 9, Volume I, and shown in detail on Plates 228 and 229, Volume I; the slight difference is that the traversing arrangement incorporated in the mechanism for the Model E mount is here used in the front end only for the purpose of aligning the mount over the pivot before lowering.

313. When the mount is to be emplaced it is run into position over the base plate with the pedestal base over the corresponding depression in the base plate. The car body is then lowered until the pedestal rests on the base plate and the rollers on the track. Further operation of the lowering mechanism disengages the king pin and the trucks can run out forward and to the rear. The portion of the weight of the mount that rests on the pedestal is carried on 34 steel balls 4 inches in diameter. As mentioned before, the pedestal is swung between the side girders of the car body by means of trunnions, and as the mount is traversed it may rotate slightly in a vertical plane if there are any irregularities in the track. It may be of interest to call attention to a contrast in design here. In the German mounts the design is such that the base section of the traversing pedestal may be dropped over the anchor bolts by means of a special lowering screw. This scheme required the use of cumbersome screw jacks to be used in raising the car body for the purpose of removing the trucks and lowering the car body onto the traversing track and pedestal bearing. The design employed in the mount under discussion is certainly much superior. The traversing rollers are operated by motor and speed gear for following a moving target. Hand operation is also provided. An azimuth circle and pointer with vernier adjustment for direct readings to one hundredth of a degree are also incorporated in the car traversing arrangement for indirect fire.

314. An additional possibility may be mentioned, although it is not seriously contemplated. It seems quite possible that this mount could be operated as a rolling mount to quite a satisfactory elevation. In this event it would, of course, have to be operated on a curved track to secure the proper traverse. When operating on a 17-degree curve the full traverse of the top carriage, viz, 3.5 degrees on each side, may safely be used.

315. *Top carriage.*—This top carriage, Plate 133, is unique in practically every significant detail of its design. First, it is pivoted at the rear instead of the front; in fact, its connection with the car body is through a universal joint, for it can swing in a vertical as well as in a horizontal plane. Second, it embodies a particularly efficient type of antifriction mechanism which has not been used on any other of our railway mounts. Third, it is the second top car-

riage of American design that permits the gun to travel low and operate high (see Navy 14-inch mount, Mark II, Vol. I, for the other design), and the only design in existence, to the best of our knowledge, that permits of this through a horizontal axle at one end and lifting screws at the other.

316. The universal joint at the rear of the carriage is worthy of careful examination. It comprises a heavy steel bracket in two parts, attached quite rigidly to the railway car body. A second steel casting fits into this bracket by means of its vertical trunnions and can rotate about these trunnions in a horizontal plane. A heavy axle that acts as a rear transom for the top-carriage side frames passes entirely through this steel joint, thereby permitting the carriage to rotate in a vertical plane. The result is, of course, a universal joint. The vertical motion is required to permit the gun to be raised or lowered for action or travel. The horizontal motion is required to permit the 7 degrees traverse of the top-carriage with respect to the railway car body.

317. The raising and lowering mechanism at the front end, Plate 142, comprises two long screws, each having a head with trunnions at the lower end so that they may be slipped between, and the trunnions under, the forked extensions to the front ends of the side frames. The screw heads are disengaged after the carriage has been raised and screws run down. Each screw passes through a bevel gear which forms a nut and is carried in an oscillating housing in the cast stand seen just in front of the top carriage, Plate 133. The two bevel gears are driven through other bevel gears from the same shaft which in turn is driven by the electric motor. It requires about five minutes to raise the carriage by this mechanism.

318. When the carriage is raised to the limit, the supporting beam, Plate 140, which travels forward against the screw stands, is moved to the rear by means of the hand-operated gear-translating mechanism until the stops strike, which is when the roller path is exactly under the conical traversing rollers. As the supporting beam is moved rearward, a lug thereon enters a groove in the slide at front end of top carriage. This slide is operated by a screw actuated by a handwheel on either side of the top carriage. Two men are required to move the supporting beam either forward or back in 10 seconds. One turn of the traversing handwheel moves the carriage through 0.487 mils in azimuth.

319. *Railway car body.*—The only features of the car body that seem worthy of special attention are the raising and lowering mechanisms, which are driven by power and by hand, give a vertical motion of mount of 5 inches and each requires 16 men to operate it by hand. The car can be lowered by power in approximately 1.5

minutes and raised in 1.5 minutes. They are similar in design with the mechanisms used on the 14-inch mount, Model E, Plates 228-229, Vol. I.

320. *System of anchorage.*—The system of anchorage is, so to speak, in multiple, since provision is made for operating the mount in several different ways. At the rear of the mount, Plate 133, four heavy steel struts will be seen, that will recall the 16-inch howitzer mount, Model 1918. Whenever the mount is used on a curved track for field operations these struts will be set in place. Structural steel pads are provided, having steel sockets mounted on them to take the ball end of the struts. The struts transmit the total horizontal component of the force of recoil into the earth. Two similar struts or outriggers, not shown on this plate, are attached to front end of mount to absorb counter recoil forces. The second scheme of anchorage is used when the mount is operated on a concrete emplacement. In this case the pedestal base fits into a depression in the fixed base plate, to which it is bolted and the traversing rollers rest on the steel traversing track. The pedestal transmits the entire horizontal component of the force of recoil while the rollers share with the pedestal in transmitting the vertical component. These rear rollers are suspended under Belleville springs and will yield under firing load until the housing is metal to metal with roller path. This yield is only .06 of an inch, so the "flip" of the mount is negligible.

321. A third scheme of anchoring that is possible, although not now contemplated in connection with this carriage, is simply through the wheel brakes. The mount would be used as a rolling mount under this system, as with the Navy 14-inch mount, Mark II, and the Army 16-inch howitzer mount, Model 1918. This is a scheme of anchorage that probably will not be used except in some extreme emergency.

322. *Trucks.*—The trucks are not of unusual design. They are of the locomotive type, having cast-steel frames, and in both the three and four axle trucks the axles are equalized throughout. The span bolsters are likewise of cast steel. Hand translating gearing is mounted on the inside trucks and in each truck drives two axles through chains. The driving chains are unclutched in transit. The outside trucks are equipped with air brakes which operate on the eight wheels of the forward trucks and the six wheels of the rear trucks.

323. *Ammunition supply system.*—Two high-speed power cranes with a swing radius of about 12.5 feet are provided on the rear of mount. With the mount on emplacement, and following a moving

target, the cranes have constant access to a number of hand propelled shell and powder cars which keep pace with the mount traversing speed on a narrow gauge circular track. These small cars are brought up loaded, to the circular track, from the magazine or large car in the rear by an electric or gasoline driven locomotive and can be readily shunted back by hand power when empty. This circulating arrangement of small shell and powder cars is similar to that employed in supplying charges for the 16-inch Barbette carriage, Model of 1919.

324. When firing from the track with outriggers in place the cranes are used to supply ammunition directly from a large car in rear of mount or from parking platforms alongside.

325. Directly under the crane head, Plate 133, is a fixed loading tray which houses a spanning tray that is run out to bridge the gap to the breech opening. Both fixed and spanning trays are inclined 7 degrees and a slight impetus at the start is sufficient to seat the shell in the bore of the gun. The platform at the breech is counter-balanced and, by means of a foot pedal, can be quickly raised to clear the recoil of the gun when firing at low angles. The cranes and loading tray are so designed that they may be collapsed to come within the railway clearances when traveling. The dominant idea in the whole loading and ammunition supply scheme is to compete, in point of rapidity of fire, with the 16-inch Barbette and the later models of the disappearing carriages.

326. Power for the operation and lighting of this mount is supplied by a gasoline-driven 50 kilowatt generator set mounted on front span bolster, Plate 133. The various mechanisms are all provided with alternate hand-power facilities.

TABLES OF CLASSIFIED DATA.

General data.						
Type of gun.	Length calibers.	Model.	Life of gun (full rds.).	Max. km. range.	Make of mount.	Type of mount.
French:						
1	155 howitzer..	27	1877.....	12.7	Schneider.....	Track plt'fm A. R. F.
2	164.7 gun.....	45	1893.....	2,800	do.....	Do.
3	194.4 howitzer.	19	1875-76.....	4,000	do.....	Track plt'fm Epi.
4	do.....	19	1875-76.....	4,000	do.....	Do.
5	do.....	19	1875-76-78.....	12.8	do.....	Do.
6	194.4 gun.....		1893-96-87-02.....	17.0	Schneider.....	Track plt'fm A. R. F.
7	do.....	28.5	1870-93.....	1,700	do.....	Do.
8	do.....	28.5	1870-93.....	1,700	Schneider.....	Track plt'fm Epi.
9	do.....	28.5	1870-93.....	1,700	do.....	Track plt'fm A. R. F.
10	200 howitzer..	15	1893.....	4,000	do.....	Do.
11	240 howitzer..	20	1876.....	3,000	do.....	Track plt'fm Epi.
12	do.....	20	1876.....	3,000	do.....	Do.
13	do.....	20	1876.....	3,000	do.....	Do.
14	240 gun.....	40	1893-96.....	500	St. Chamond.....	Track plt'fm A. R. F.
15	do.....	26	1884.....	2,400	Schneider.....	Track plt'fm Epi.
16	do.....	25	1884.....	2,400	do.....	Track plt'fm A. R. F.
17	do.....	28.5	1870-84-87.....	16.0	do.....	Do.
18	do.....	27	1903.....	2,400	Schneider.....	Gr'nd plt'fm L. F.
19	274.4 howitzer.	25-15	1870-81-70M.....	3,500	do.....	Track plt'fm Epi.
20	274.4 gun.....	25	1893.....	20.0	do.....	Do.
21	274.4 gun.....	40	1893-96.....	27.0	do.....	Sliding.
22	do.....	40	1893-96.....	24.0	do.....	Track plt'fm L. F.
23	285 gun.....	38	1893-96.....	550	do.....	Do.
24	293 mortar....	15	1914-15.....	1,500	do.....	Gr'nd. plt'fm L. F.
25	305 gun.....	40	1893-96-06.....	300	Batignolle.....	Do.
26	do.....	40	1893-96.....	300	St. Chamond.....	Do.
27	do.....	40	1893-96.....	300	Schneider.....	Sliding.
28	do.....	45	1906-10.....	do.....	do.....	Do.
29	320 howitzer..	30	1870-84-93.....	750	do.....	Do.
30	do.....	25	1870-81.....	1,100	do.....	Do.
31	do.....	28.5	1881-84.....	20.0	do.....	Do.
32	340 gun.....	35	1893.....	400	do.....	Do.
33	do.....	45	1912.....	250	St. Chamond.....	Gr'nd plt'fm L. F.
34	do.....	45	1912.....	250	Schneider.....	Sliding.
35	370 howitzer..	25	305mm-1887.....	1,100	Batignolle.....	Gr'nd plt'fm L. F.
36	do.....	28	1875-79.....	do.....	Schneider.....	Sliding.
37	400 howitzer..	25	340mm-1887.....	1,100	St. Chamond.....	Gr'nd plt'fm L. F.
38	520 howitzer..	16	do.....	17.5	Schneider.....	Sliding.
British:						
39	9.2" gun.....	35	XIII.....	do.....	Armstrong MK4.	Track plt'fm A. R. F.
40	do.....	45	X-XIV.....	do.....	Armstrong MK2-3	Do.
41	do.....	31.5	III to VIC.....	do.....	Armstrong MKI.	Wheels L. F.
42	12" howitzer..	12	MKI.....	do.....	Armstrong E.O.C.	Gr'nd plt'fm A. R. F.
43	do.....	17.3	MKIII.....	do.....	Armstrong MKII	Track plt'fm A. R. F.
44	12" gun.....	40	MKIX.....	23.1	Vickers.....	Wheels L. F.
45	14" gun.....	45	MKIII.....	do.....	Armstrong.....	Do.
Italian:						
46	380 gun.....	40	do.....	do.....	Ansaldo.....	Sliding.

NOTE.—The numbers in the first column are for reference only. They do not refer to the number given the mounts in the text.

General measurements—meters.

	Length mt. over buffers.	C. to C. of trucks.	Hgt. of trunnion above rails.	Max. width of mount	Length amm. car over buffers.	C. to C. amm. car trucks.	Max. hgt. amm. car above rails.	Rds. in amm. car.
1	8.100		2.280	2.65 ±				
2	14.700	7.700	3.303	3.024				120
3	7.250		2.463	2.44±				100
4	7.570		2.780	2.60±				100
5	8.23±		2.480					100
6								
7	10.00±							100
8	8.120							100
9	14.700	7.700	3.726	3.024				100
10	12.120		2.900	2.83±	9.44			64
11								48
12	8.120		2.840	2.79±				48
13	7.425		2.690	2.50±				48
14	19.500	11.000	3.810		8.750			40
15	9.840		3.060	2.89±				48
16								48
17								
18	9.060		2.400	2.513				48
19	9.720		3.343	2.88±				
20	10.650	5.750	3.250	3.02±				28
21	25.900	15.000	3.530	2.87				
22	18.470	11.300	3.200	2.93±				
23	18.470	11.300	3.400					27
24	9.860			2.513±				31
25	20.000	15.000	3.530					20
26	19.500	11.000	3.650		8.750			23
27	27.200	17.300	3.530	2.96	11.800		3.66	28
28	27.200	17.300	3.531	2.96				
29	25.900	15.000	3.530	2.71				28
30	26.000		3.530	2.71				28
31	27.200	17.300	3.452	3.50±				
32	27.200							20
33	19.500	11.000	3.400	2.90	8.750			20
34	33.550	18.580	3.500	3.00				
35	19.060	12.070	3.250	2.86±				20
36	33.220	18.300	3.395					
37	19.390	12.000	3.150		8.750			12
38	30.380	17.000	3.155	2.80±				12 to 20
39	14.326	9.144	3.200					
40	14.326	9.144	3.200					
41	14.833	10.820		2.366				
42	13.563	9.144						
43	16.3±	9.144	3.39±					
44	26.630	15.011	3.120	2.391	9.144	4.572	3.94	
45	26.620	16.230	3.270	2.590	11.310	5.975	3.970	96
46	24.600	14.88±	3.26±	2.75±	15±	8.87±	3.75±	29

Weight—kilograms.

	Gun and breech.	Recoiling parts.	Top carriage complete.	Car body.	Span bolster.	Trucks.	Total weight on tracks.	Axle load.	Platform material.	Amm. car empty.	Amm. car loaded.	Axle load amm. car.
1	2,520						44,000	11,000				
2	7,040						60,000	15,000				
3	8,000						24,500	12,250				
4	8,000						28,000	14,000				
5	8,000						27,000	9,000				
6	8,000						72,500	14,500				
7	10,472						70,000	14,000				
8		25,800			14,200		40,000	13,300				
9	10,472						65,000	16,250				
10	3,700		10,450		24,100		38,243	9,560		17,000	22,500	7,500
11	16,250						35,700	17,880				
12	16,250						41,000	13,666				
13	16,250						41,000	13,666				
14	29,000		45,000		33,000	34,000	141,000	11,750	14,000	18,160	27,216	13,608
15	13,980						72,000	14,460				
16							72,000	14,400				
17	20,000						90,000	15,000				
18	17,800						47,800	22,990				
19	25,300						78,000	15,600				
20	22,200						68,000	17,000				
21	35,400			92,180			152,000	15,200				
22	35,040						116,000	14,500				
23	38,000						120,000	15,000				
24	8,220	11,700			38,300		50,660	25,330				
25	48,000	56,000					140,000	17,500				
26	55,000			28,000		32,000	160,000	13,300		18,000	28,600	14,300
27	55,300			85,700		40,000	182,000	15,100				
28	78,000						208,000	17,400				
29	48,240			81,000		32,000	162,000	16,200				
30	43,100						160,000	16,000				
31	58,700						187,000	15,580				
32	53,000						180,000	15,000				
33	65,400			32,000		32,000	166,000	14,050	6,000	18,500	32,600	16,360
34	98,600						270,000	16,900				
35	38,000	46,000		58,000		31,000	155,000	16,900	15,000			
36	76,300			88,700	32,000	53,000	250,000	15,600				
37	47,580		36,500	28,000		28,000	140,000	14,000	28,000	18,000	29,700	14,850
38	44,100	65,500		98,500	32,000	53,000	263,000	16,400				
39	24,375			49,512		14,219	88,106	14,684				
40	28,437 27,422			49,512		14,219	92,168 91,153	15,361 15,192				
41	24,375 23,359		8,125		29,149		61,649 60,633	15,412 15,158				
42	9,014		12,683		37,071		58,768	14,692				
43	11,524		13,173		37,096		61,793	15,448				
44	53,729	28,000		40,626	15,641	53,168	189,164	13,512				
45	85,259		91,408		17,265	58,395	252,327	17,560		32,505	101,564	16,927
46	62,600	82,500	145,100				212,000	15,100				

	Gun.						Mount.		
	Rifling.						Max. powder pressure (KG-SQ. cm.).	Traverse.	Firing angle.
	Grooves.			Width lands (cms.).	Velocity rotation at muzzle (r. p. m.).	Twist calibers.			
	No.	Width (cms.).	Depth (cms.).						
1							360°	<i>Min.</i> 0° <i>Max.</i> 35°	
2	50				5°	2,000	360° top carr.	10° 36°	
3	60				7°	1,800	EPI curve	0° 40°	
4	60				7°	1,800	EPI curve	0° 40°	
5	60				7°	1,800			
6									
7	38				7°	2,200	360°		
8	38				7°	2,200	EPI curve	0° 40°	
9	38				7°	2,200	360°	10° 30°	
10	60				12°	2,150	360°	5° 60°	
11	60				7°		EPI curve	0° 40°	
12	60				7°			0° 40°	
13	60				7°			5° 40°	
14	72				4°	2,700	360°	15° 35°	
15	72				7°	1,850		10° 40°	
16							360°		
17	72				7°		360°	0° 30°	
18	72				7°	2,050	14°	10° 35°	
19							0°	1° 37°	
20	82				5°	2,350	0°	15° 37°	
21							0°	1° 30' 40"	
22	82				5°		2°	0° 25°	
23	84				5° 25'	2,400	2°	0° 25°	
24	92				9°	2,300	14°	20° 65°	
25	90				4°	2,800	10°	15° 38°	
26	90				4°		20°	-4° 20°	
27	90				4°	2,800	0°	3° 38°	
28							0°	2° 30' 38"	
29	64				7°		0°	3° 40°	
30	64				7°	2,150	0°	22° 40°	
31	102				4° right		0°	3° 40°	
32	102				5°	2,500		3° 40°	
33	102				4° right	2,700	10°	15° 42°	
34							0°	3° 30' 37"	
35	112				7°	1,750	12°	15° 65°	
36	112				7°		0°	3° 40°	
37	120				7°		12°	15° 65°	
38	168				7°	2,200	0°	20° 60°	
39	46	1.06	0.1774		1 in 30 cal.		360°	0° 40°	
40	46	1.06	.1774		1 in 30 cal.		360°	0° 30°	
41	37	1.525	.127		Max. 1 in 30.		20°	0° 35°	
42	60				1 in 15 cal.		360°	40° 65°	
43	60				1 in 15 cal.		240°	40° 65°	
44	48	1.58	.254	0.416	1 in 30 cal.	2,835	2°	10° 35° 30'	
45	84				1 in 28 cal.		4°	0° 40°	
46							2°	0° 25°	

Dimensions of gun.									
	Total length (meters).	Length of bore (calibers).	Dia. over powder chamber (M.).	Dia. of muzzle (meters).	Max. Dia. powder chamber (M.).	Length powder chamber (M.).	Capacity powder chamber (cu. m.).	Muzzle velocity (Max. M/Sec.).	Muzzle energy (Max. T. M.).
1	4.200	27							
2	7.672	45							
3	4.150	19							
4	4.15	19							
5		19							
6									
7		28.5							
8		28.5							
9		28.5							
10	3.0±	15							
11	5.365								
12	5.27±							427	
13	5.365							427	
14	10.055	40						850	
15	6.75±							528	
16									
17	7.22	28.5						610	
18	6.48								
19	7.30							567	
20	7.30±							660	
21	11.35±							815	8.632
22	11.50	40						815	
23									
24	4.395	15						398	
25									11.510
26	12.775								
27	12.78								
28	14.175							780	
29	10.112							550	7.709
30								520	
31	10.2±							600	
32									
33	16.115								
34	16.62							800	
35	9.855							535	9.047
36	11.14±							650	12.058
37	10.65							530	
38	8.35								17.839
39	8.520								
40	11.236								
41	10.846								
41	7.874	31.5			0.305	1.092	0.0811		
42	4.12	12			.325	.498	.0421		
43	5.715	17.3			.325	.710	.068		
44	12.611	40	1.133	0.635	.445	2.358	.293		10.680
45	16.469	45	1.499	.676					
46								700	

Mount.							
Num. ber.	Trucks.		Recoil system.	Length of recoil.	Anchorage.	Loading system.	Max. rate of fire, rds. per hr.
	Wheels, each.						
				<i>Meters.</i>			
1	2	4	Top carriage.....		Track platform.....		
2	2	4do.....	do.....		15
3	1	4	Cradle-carr. on rollers .	1.200±do.....	Crane and tray.....	
4	1	4	Top carr. on rollers.....	do.....do.....	
5	1	6do.....	do.....		
6	1	10do.....	do.....		
7	1	10	Top carriage.....		T r a c k platform and guy.		
8	1	6do.....	do.....		
9	2	4	Top carr. on rollers.....		Track platform.....	Tray.....	40
10	2	4	Cradle.....	do.....do.....	90
11	1	4	Top carr. on rollers.....		T r a c k platform and guy.	Crane and tray.....	30
12	1	6do.....	do.....	Crane.....	
13	1	6do.....	do.....	Crane and tray.....	
14	2	12do.....	1.100.	T r a c k platform and struts.	O. H. trolley.....	30
15	1	10do.....		Sliding.....	Crane and tray.....	
16	1	10do.....		T r a c k platform and guy.		
17	2	6do.....		T r a c k platform and clamps.	Shell car.....	30
18	1	4	Cradle.....		Gr'nd platform.....	Shot trucks.....	30
19	1	10	Top carr. on rollers.....		Sliding.....	Crane and tray.....	
20	2	4do.....		Track platform.....	Shot truck.....	15
21	2	10	Glissement.....		Sliding.....	Trolley and tray.....	
22	2	8	Cradle.....		T r a c k platform and clamps.		20
23	2	8do.....	do.....		15
24	1	4do.....		Gr'nd platform.....	Shot truck.....	30
25	2	8do.....	do.....	Crane and tray.....	15
26	2	12	Top carr. on rollers.....	1.100.	Gr'nd platform and struts.		20
27	2	12	Glissement.....		Sliding.....	Trolley and tray.....	15
28	2	12do.....	do.....do.....	
29	2	10do.....	do.....do.....	20
30	2	10do.....	do.....do.....	15
31	2	12do.....	do.....do.....	20
32	2	12do.....	do.....do.....	20
33	2	12	Cradle.....	0.875.	Gr'nd platform.....	Crane.....	20
34	4	8	Glissement.....		Sliding.....	Trolley and tray.....	20
35	2	8	Cradle.....		Gr'nd platform.....	Crane and tray.....	20
36	4	8	Glissement.....		Sliding.....	Trolley and tray.....	
37	2	8-12	Cradle.....	0.875.	Gr'nd platform.....	Crane and tray.....	20
38	4	8do.....	0.945.	Sliding.....	Trolley tray.....	10
39	2	6	Top carr. on rollers.....	0.950.	Track platform.....	Crane shot tr'k.....	
40	2	6do.....	0.950.do.....do.....	
41	2	4do.....	0.711.	Rolling.....	Crane and tray.....	
42	2	4	Cradle.....	0.813' max.	T r a c k platform rail clamps.do.....	
43	2	4do.....	1.57 M. to M.	T r a c k platform clamps and guys.do.....	
44	4	6-8do.....	0.838 max.	Rolling.....	Shot truck.....	
45	4	6-8do.....	0.915 max.do.....	Crane, shot tr'k.....	
46	4	6-8do.....	1.22.	Sliding.....	Trolley.....	3

Projectile.						
Type.	Weight	Weight of charge.		Initial velocity.	Length, base to point.	Range, max. carr. elev.
		Explosive.	Propelling.			
	<i>Kg.</i>	<i>Kg.</i>	<i>Kg.</i>	<i>M.-secs.</i>	<i>Mm.</i>	<i>Km.</i>
1	43	4.4	5.97	600		12.7
2 C. S.	52	3.0	13.7	770		18.0
3 F. A. D. 1916 cast steel	83		7.2	470		13.0
4 F. A. O. cast steel	83		7.2	470		13.0
5 do.	83		7.2	470		13.0
6						
7	86		13.5	630		16.5
8	86		13.5	630		16.5
9	86		13.5	630		16.5
10 F. A. C. S.	100	9.0	6.05	425		11.5
11						
12	163	17.5	13	427		13.0
13	163	17.5	13	427		13.0
14 F. A. 1916 C. S.	162		64.4	850		22.0
15	173		22	528		17.3
16	173		22	528		17.3
17 M. false C. S.	153.6	15				
18 A. steel	140	26	23	614		16.8
19	216		27	567		14.0
20	255		49.4	660		20.0
21 D. 6-5.	255	22	85	815		27.0
22	255			815		24.0
23 51 st.	273					21.9
24 A. C. steel	300	40	15.25	398		10.8
25 A. C. ogive 31-3-15 steel	348	29.35	107.3	795		27.0
26	350		110	815		20.0
27	340	28		815		27.0
28	435		128	780		
29 C. S.	345	38				17.8
30 C. S.	360	36	37.4	520		16.3
31	420		64	600		
32 C. S.	465	52.43	114	720		25.4
33	550		155	800		32.0
34	540		155	800		33.0
35 A. C. steel	710	72.34	70	500		16.5
36	560		104	650		
37 Steel	900	90	74	465		15.1
38 Type "D"	1,400	300	150	500		17.5
39						
40 MK. VIII.	172		54.5			
41 H. E.	173		27			
42 MK. III, H. E.	341		14.9			
43						
44 II, Vg., VII g.	386.36		106.4	770		
45						
46	885			700		

Projectile.							
	Type.	Weight.	Weight of charge.		Initial velocity.	Length, base to point.	Range, max. carr. elev.
			Explosive.	Propelling.			
		<i>Kg.</i>	<i>Kg.</i>	<i>Kg.</i>	<i>M.-secs.</i>	<i>Mm.</i>	<i>Km.</i>
1							
2	C. S.	54.9	0.970	13.155	770		15.4
3		86		5.52	400		11.5
4		86		5.52	400		11.5
5		86		5.52	400		
6							
7		82	8.2	13.6	640		15.4
8		82	8.2	13.6	640		15.4
9	C. S., F. A.	82	8.2	13.6	640		15.4
10							
11							
12							
13							
14							
15	A. steel.....	140		25	614		
16	A. steel.....	140		25	614		12.9
17	P.....	160	34	20.2	526		14.9
18		160			610		17.0
19							
20	A. T.....	216	33.5	42.7	643		16.8
21	Steel.....	216	33.5	7	790		21.7
22							
23	F. A. T. O., C. S.....	270	23	79.3	740		21.9
24	F. A. C., C. S.....	300	25	11.3	322		8.5
25							
26							
27	A. M. O.....	340	28	107.7	827		30.9
28							
29	A. C. 9-8-15.....	506	50	75.5	579		18.8
30	Steel Schndr.....	506	50	49.9	490		15.37
31	Steel 5-1-16.....	427	64.15				19.0
32	Steel.....	440	34				
33	1915-1-5-16.....	465	52.43	153	850		30.7
34	F. A. Ogive, tongue casts.	440	34				
35	A. T. steel.....	516	143.3	56.2	535		16.5
36							
37	Steel.....	640	180.2	66.3	530		16.1
38							
39							
40							
41							
42							
43							
44	II A.....	386		112			
45							
46							

Projectile.						
Type.	Weight.	Weight of charge.		Initial velocity.	Length, base to point.	Range, max. carr. elev.
		Explosive.	Propelling.			
	<i>Kg.</i>	<i>Kg.</i>	<i>Kg.</i>	<i>M.-secs.</i>	<i>Mm.</i>	<i>Km.</i>
1						
2						
3	F. A.	81.5		6.9	473	12.3
4	do.	81.5		6.9	473	12.3
5	do.	81.5		6.9	473	12.3
6						
7	Steel	85.35	16	11.8	555	12
8	do.	85.35	16	11.8	555	12
9	do.	85.35	16	11.8	555	12
10						
11	F. A. G.	161.6	17.5	13.25	460	13.7
12	do.	161.6	17.5	13.25	460	13.7
13	do.	161.6	17.5	13.25	460	13.7
14						
15	P. steel	163	34	20.2	520	13.0
16	do.	163	34	20.2	520	13.0
17	D-C. 5.	160	16			
18	P. steel	163	34	18.5	520	13.0
19		256		21.5	470	14.2
20	F. A. T. O.	237.5	17	42.7	630	20.5
21	Steel	261	29.4		740	24.4
22						
23	F. A. C. S.	278	23	79.3	736	19.2
24	A. T. steel	226	64	16.5	466	12.2
25	F. A. B.	351.5	32	107.3	791	26.6
26						
27	F. A., type B.	351	31	107.4	791	26.7
28						
29	D. A. L. V. F.	387	36.8	56.9	608	20.6
30	F. A. L. V. F.	387	36.8	37.4	506	16.2
31	F. A., ogive cast.	440	34			19.0
32	Steel	427	64.15	114	740	26.8
33	R-1-10-12 steel	540	21.65	152	800	26.4
34	F. A., May, 1915.	465	52.43			31.3
35	C. S.	710	58.5	63.1	475	14.75
36						
37	C. S.	890	72.5	74	467	15.1
38						
39						
40						
41						
42						
43						
44						
45						
46						

Projectile.						
Type.	Weight.	Weight of charge.		Initial velocity.	Length, base to point.	Range, max. carr. elev.
		Explosive.	Propelling.			
	<i>Kg.</i>	<i>Kg.</i>	<i>Kg.</i>	<i>M. secs.</i>	<i>M.n.</i>	<i>Km.</i>
1						
2	Steel shrap.	45		13.7	800	13.400
3	D.-C. S.	82	8.2	7.2	470	12.800
4	D.-C. S.	82	8.2	7.2	470	12.800
5	D.-C. S.	82	8.2	7.2	470	
6						
7	F. A. O.	83.5		13.6	638	16.500
8	F. A. O.	83.5		13.6	638	16.500
9	F. A. O.	83.5		13.6	638	16.500
10						
11						
12						
13						
14						
15						
16						
17	A.	140	26	25	614	12.900
18						
19						
20						
21						
22						
23						
24						
25						
26						
27	Steel.	350	30	107.3	795	27.400
28						
29	Ogive C. S.	392	36.5	56.9	609	20.150
30	C. S. false ogive.	357	39	37.4	506	15.440
31	F. A. C. S.	465	52.43			18.300
32						
33						
34						
35						
36						
37						
38						
39						
40						
41						
42						
43						
44						
45						
46						

